

> ENVIRONNEMENT  
MOTEUR

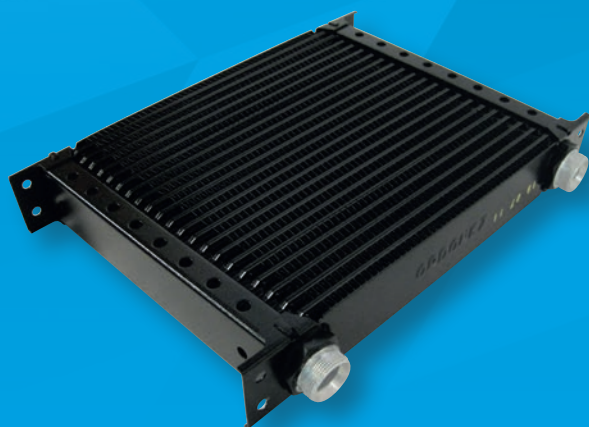

ENVIRONNEMENT  
MOTEUR

CATALOGUE  
2016 - 2018



**ATS**

Pièces pour bus et cars

RÉF ATS	APPLICATION	DIMENSION	MOTEUR
<b>CUMMINS</b>			
<b>69051</b>	BMC Probus, Alyos, Temsa Box, Tourmalin	70 X 100 X 12,5 X 16	Moteur ISBE4
<b>DAF</b>			
<b>69318</b>	Bova FHD, Magiq, Temsa Safari	100 X 124 X 12	Moteur XE280C Euro 3
<b>69336</b>	Bova Lexio, FHD, Temsa Box, Tourmalin	120 X 150 X 15	Moteur PE, PF Euro 4
<b>66060</b>	Bova FHD, Magiq, Temsa Safari, Vanhool T9	154 X 180 X 12	Moteur MX Euro 4
<b>FAST</b>			
<b>65023</b>	Fast Scoler 1, 2	110 X 130 X 12	Moteur 060226W
<b>65358</b>	Fast Scoler 3 A91	110 X 130 X 13	Moteur D0836 LOH Euro 3, 4
<b>61361</b>	Fast Scoler 3 A91	120 X 140 X 13	Moteur D2066 LOH, Euro 4, 5
<b>64991</b>	Fast Scoler 3, Sampler	160 X 190 X 13	Moteur DCI 6 Euro 3
<b>77692</b>	Fast Scoler 4	130 X 150 X 13	Moteur DXI7
<b>65357</b>	Fast Syter A51	120 X 140 X 13 Joint spy	Moteur D2866 Euro 3
<b>23050</b>		Frête volant	
<b>IVECO/IRISBUS</b>			
<b>4748</b>	Irisbus FR1, Iliade, Ares, Tracer		Moteur RVI Moteur 0622045 Euro 0, 1, 2
<b>64991</b>	Irisbus Iliade, Ares	160 X 190 X 13	Moteur Renault DCI Euro 3
<b>64750</b>	Irisbus Mago, Midys, Recreo, Crossway		Moteur tector Euro 3, 4, 5, 6
<b>65025</b>	Irisbus Recreo, Axer, Ares, Arway, Evadys		Moteur Cursor 8 F2BE Euro 3, 4, 5
<b>76615</b>	Irisbus Crossway, Arway, Magelys	130 X 160 X 14	Moteur Cursor 9 Euro 6
<b>76615</b>	Irisbus Evadys, Ares 15 m, Magelys, Domino	130 X 160 X 14	Moteur Cursor 10 F3AE Euro 4, 5
<b>70825</b>	Irisbus Daily 65C13, 14, 15, 17, 18 50C15, 18 dep 11/01	90 X 120 X 13/12,5	Moteur F1CE0481
<b>MAN</b>			
<b>65357</b>	Man, Bova FHX, Neoplan, Vanhool T8, T9	120 X 140 X 13 Joint spy	Moteur D2866, D2876 Euro 0, 1, 2, 3
<b>23050</b>		Frête volant	
<b>65358</b>	Man SU 283, Lion's Regio, Fast scoler 3	110 X 130 X 13	Moteur D0836 LOH Euro 3, 4
<b>61361</b>	Man Lion's Coach R07, R08, Neoplan Trendliner, Skyliner, Tourliner, Temsa Safari, Vanhool T9	120 X 140 X 13	Moteur D2066 LOH, LUH Euro 4, 5
<b>MERCEDES</b>			
<b>77683</b>	Mercedes Sprinter 511, 513, 515, 516 CDI		Moteur OM646DELA Euro 4
<b>77682</b>	Mercedes Sprinter 518, 519 CDI		Moteur OM642
<b>65037</b>	Mercedes Setra série 400, Setra série 300 Euro 3, 0345 Euro 3, 0350 Euro 3, 0550 Euro 3, 0580 Euro 3, 4 Integro, Turismo, Tourino, Intouro, Vario, Mediano, 0814, 0815	115 X 140 X 12	Moteur OM457 LA / HLA, OM926 LA, OM904LA Euro 3, 4, 5
<b>65037</b>	Mercedes Setra 411HD, Neoplan Euroliner	115 X 140 X 12	Moteur OM501LA Euro 3, 4
<b>65357</b>	Mercedes Integro, Turismo, Setra série 300, 0404	120 X 140 X 13	Moteur OM441LA, 447HLA, 442LA
<b>65037</b>	Mercedes Intouro, Multiclass 400, Multiclass 500, Turismo, comfort	115 X 140 X 12	Moteur OM936LA Euro 6
<b>94849</b>	Mercedes Turismo, Travego, Multiclass 400, Top class 500, Comfort class 500	138 X 163 X 12	Moteur OM470 Euro 6

RÉF ATS	APPLICATION	DIMENSION	MOTEUR
<b>SCANIA</b>			
<b>64738</b>	Scania Irizar Century, PB	145 X 175 X 13	Moteur DSC1202 Euro 3, 4, 5
<b>64739</b>	Scania Irizar Century	130 X 160 X 15	Moteur DSC11 - K113, CLB, CLP, TLP, CLA, CRA Euro 0, 1, 2
<b>VOLVO</b>			
<b>35125</b>	B10B/B10 BLE, B10L, B10M, B10M (BR), B10R, B12/B12(BR)	155 X 180 X 15	THD 101, 102, 103/DH 10A - GH 10A, B - THG103/THD104/DH10A - GH10A, B, C - THD100, 101, 102, 104/DH10A - GH10A - DH10A - THD100 - TD122, 123 - THD100/101/102 - TD102/D10A - D10A
<b>64741</b>	B12 - B12B - B12M	180 X 205 X 15	D12C, DH12D, DH12C-D
<b>64740</b>	B6/B6 BLE - B7 - B7F - B7L/B7L DD - B7R/B7R (BR)	126 X 150 X 13	TD63, D6A - TD73, D7A - D7A-B - D7C - D7A-B-C

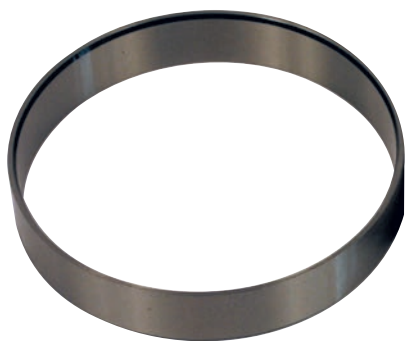

### VIS DE MÉCANISME

RÉF ATS	APPLICATION	DIMENSION	NOMBRE	MOTEUR
<b>IVECO/IRISBUS</b>				
<b>38849</b>	Irisbus FR1, Iliade, Ares, Tracer, Recreo	10 X 70	12	Moteur MIDR062045 Euro 0, 1, 2
<b>38849</b>	Irisbus Recreo	10 X 70	8	Moteur Tector F4AE Euro 4, 5
<b>77684</b>	Irisbus Recreo, Axer, Ares, Crossway, Arway, Evadys	M10 X 1,5	8 vis	Moteur Cursor F2BE
<b>77685</b>		10,5 X 21	8 rondelles	
<b>77684</b>	Evadys, Ares 15 m, Magelys, Domino	10 X 1,5	12	Moteur Cursor F3AE
<b>77685</b>		10,5 X 21	12 rondelles	
<b>MERCEDES</b>				
<b>38839</b>	Mercedes Setra 309-316, 0345, 0350, 0404, 0550 Integro, S411-S416UL	10 X 80	12	Moteur OM401LA, OM402LA, OM422, OM441LA, OM442 A, LA, OM447HLA, OM457HLA



RÉF ATS	APPLICATION	DIMENSION	NOMBRE	MOTEUR
<b>CUMMINS</b>				
<b>66212</b>	BMC Probus, Alyos, Temsa Box, Tourmalin			Moteur ISBE4
<b>DAF</b>				
<b>52744</b>	Bova FLD, FHD, Temsa Safari, Tourmalin, Vanhool T9			Moteur WS242M, WS268, PE, PF, PR- XE280C, XE375C, XE250C, MX265, 340, 300
<b>IVECO/IRISBUS</b>				
<b>66212</b>	Irisbus FR1, Iliade, Ares, Tracer, Recreo			Moteur MIDR062045 Euro 0, 1, 2
<b>66212</b>	Irisbus Ares, Iliade			Moteur DCI 11 Euro 3
<b>66896</b>	Irisbus, Fast Sampler, Fast Scoler 3			Moteur DCI 6 Euro 3
<b>66896</b>	Irisbus, Recreo, Axer, Arway, Crossway, Ares			Moteur Cursor 8 F2BE
<b>66896</b>	Irisbus Recreo New, Crossway, Midys			Moteur Tector F4AE, Tector 7
<b>MAN</b>				
<b>66213</b>	Man SU283, 313, Lion's Coach R07, R08, Tourliner, Trendliner, Euroliner, Skyliner, Starliner, Vanhool T9, Temsa Safari, Fast Syter			Moteur D2866, D2876, D2066
<b>76441</b>	Man SU263, Lion's Regio, Fast Scoler 3			Moteur D0836 LOH
<b>MERCEDES</b>				
<b>77695</b>	Mercedes 0510 Tourino, 0560 Intouro			Moteur OM906LA, 926LA
<b>66213</b>	Mercedes 0303, 0340, 0345, 0350, 0404, 0550, 0580 Travego, Setra 211-216HDS, S309-328 DT, S411-431 DT			Moteur OM442, 441LA, OM447HLA, OM402LA, OM442LA, OM457HLA, LA OM501LA
<b>90467</b>	Comfort class 500, Top class 500, Turismo New, Multiclass 400	Ø 62 X 25 L 24 mm		Moteur OM470LA Euro 6 OM471LA
<b>94837</b>	Turismo New, Intouro, Multiclass 400, Comfort class 500			Moteur OM936LA
<b>SCANIA</b>				
<b>35129</b>	Scania Irizar Century, PB - K113, CLB, CLA, CLP, TLP, CRA K124, 114 25 X 62 X 17			Moteur DSC11, DSC1202
<b>VOLVO</b>				
<b>35126</b>	Volvo B10B/B10 BLE - B10L B10M B10M (BR) - B10R B12 - 8700, 9500, 9700, 9900 30 X 72 X 19			Moteur D9A, B, THD - 101, 102, 103 / DH10A - GH10A-B - THG103/ THD104/DH10A - GH10A-B-C - THD100, 101, 102, 104 / DH10 - GH10A DH10A - THD100 - TD122, 123 - D12A, B, C, D - D13A



RÉF ATS	APPLICATION	DIMENSION	NOMBRE	MOTEUR
<b>DAF</b>				
<b>72919</b>	Bova, Tamsa, Vanhool	M16 X 60 - 10,9	10	Moteur XE280C, XE250C, MX265, MX340, MX300
<b>FAST</b>				
<b>24437</b>	Fast Syter	M16 X 1,5 X 73	10	Moteur D2866 Euro 0, 1, 2, 3
<b>71284</b>	Fast Scoler, Syter		10	Moteur D2066LOH Euro 4, 5
<b>77728</b>	Fast Scoler 2, Fast Sampler		8	Moteur Renault 062226W DCI 6 Euro 1, 2, 3
<b>77687</b>	Fast Scoler 3	M14 X 1,5 X 40-10,9		Moteur D0836LOH
<b>IVECO/IRISBUS</b>				
<b>56629</b>	FR1, Iliade, Ares, Tracer	Vis	8	Moteur MIDR 062045 Euro 0, 1, 2
<b>56630</b>		Rondelle 15 X 26 X 1	8	
<b>56770</b>	Iliade, Ares		8	Moteur DCI 11 Euro 3
<b>64119</b>	Recreo, Midys		8	Moteur Tector F4AE
<b>56628</b>	Recreo, Axer, Crossway, Ares, Arway, Evadys	M16 X 1,5	8	Moteur Cursor 8 F2BE
<b>64117</b>	Evadys, Magelys, Domino	M12 X 28	8	Moteur Cursor 10 F3AE
<b>MAN</b>				
<b>24437</b>	Man, Vanhool T8, T9, Bova FHX, Fast Syter, Tamsa Safari	M16 X 1,5 X 73	10	Moteur D2866, D2876 Euro 0, 1, 2, 3,
<b>71284</b>	Man, Vanhool T9, Fast Scoler, Syter, Tamsa Safari		10	Moteur D2066LOH, LUH Euro 4, 5
<b>77687</b>	Fast Scoler 3, Man Lion's Regio	M14 X 1,5 X 40 - 10,9	40	Moteur D0836LOH
<b>MERCEDES</b>				
<b>62806</b>	Mercedes Vario, Mediano, 0814, 0815	M14 X 1,5 X 60	8	Moteur OM904LA
<b>62806</b>	Mercedes 0510 Tourino, 0560 Intouro	M14 X 1,5 X 60	8	Moteur OM906LA, 926LA
<b>21476</b>	Mercedes 0303, 0345, 0350, 0404, 0408, 0550, Setra 211-228, Setra 309-328DT	M 16 X 1.5 X 55	10	Moteur OM401LA, OM402LA, OM422, OM441LA, OM442 A, LA, OM447HLA
<b>58337</b>	Mercedes 0350, Travego, Turismo New, Setra 415-417HD, HDH, GTHD	Avec volant bi-masse	10	Moteur OM457LA Euro 3, 4, 5
<b>21476</b>	Mercedes Setra 411-417HD, Travego 0580	M16 X 1,5 X 55	10	Moteur OM501LA, OM502LA
<b>SCANIA</b>				
<b>Nous consulter</b>	Scania Century, PB		10	Moteur DC9, 11, 13 - DC, DT12
<b>VOLKSWAGEN</b>				
<b>77690</b>	Crafter 30-50 2,5 TDI dep 04/06			Moteur BJM, BJL, BJJ, BJK Jeu de vis



RÉF ATS	DÉSIGNATION	DIAMÈTRE	NORME	PARTICULARITÉS
<b>BMC</b>				
<b>80675</b>	BMC Probus 285C	Ø 430	Euro 5	Moteur Cummins ISBE5
<b>80654</b>	BMC Probus	Ø 362		Moteur ISBE4.5 - 221CV
<b>80681</b>	BMC Midilux	Ø 362	Euro 4	Moteur Cummins
<b>80675</b>	BMC Alyos	Ø 430	Euro 4	Moteur ISBE4.5 - 250CV
<b>DAF</b>				
<b>75286</b>	Bova FHD, FLD	Ø 430	Euro 2	Moteur XE375C, M / XE280C - 10 vis
<b>69892</b>	Bova, Temsa, Vanhool T9	Ø 430	Euro 3, 4	Moteur XE280C, XE250C, MX265, MX340, MX300 - 10 vis
<b>77662</b>		Ø 430	Euro 4, 5	Moteur MX300 (167 dents)- 12 vis
<b>90180</b>	Bova, Temsa		Euro 5	Moteur PR265, PR260S2
<b>FAST</b>				
<b>42819</b>	Fast Scoler 1, 2	Ø 350	Euro 1, 2	Moteur MIDR 060226W BV S6-36
<b>75168</b>	Fast scoler 3	Ø 430	Euro 3, 4	Moteur Man D0836 LOH01/02/03/04
<b>84937</b>	Fast scoler 3	Ø 430	Euro 5	Moteur D0836LOH 51-58/62/63
<b>69028</b>	Fast Scoler 3	Ø 488	Euro 4	Moteur D2066LOH
<b>66976</b>	Fast Syter châssis A51	Ø 430	Euro 3	Moteur D2866LOH35
<b>IVECO/IRISBUS</b>				
<b>58448</b>	Irisbus Daily			Moteur F1CE 3481LC, F1CE 0481FA/HA, F1CE 0481B
<b>66978</b>	Irisbus Ares, Iliade	Ø 430	Euro 3	Moteur DCI
<b>66977</b>	Irisbus FR1, Ares, Iliade	Ø 430	Euro 1, 2	Dep 01/93 Moteur MIDR 062045D/3/M/3 - 062045R41/M41 - 062356A41 B.V. ZF S6-85 B.V. ZF 8S180 B.V. ZF 6S150 - B.V. B8-17OR1-TBV
<b>41650</b>	Irisbus FR1	Ø 430	Euro 0	Jsq 12/93 Moteur 062045 B.V. ZF 6S150C B.V. ZF S6-90
<b>55959</b>	Irisbus Recreo, Axer, Arway	Ø 400	Euro 3	Moteur Cursor 8F2B jsq 2006 boîte ZF
<b>66318</b>	Irisbus Arway, Crossway, Recreo	Ø 430	Euro 4, 5	Moteur Cursor 8F2B dep 2006 jsq 2014
<b>94838</b>	Irisbus Crossway, Arway, Magelys HD	Ø 430	Euro 6	Moteur Cursor 9 dep 2014
<b>54504</b>	Irisbus Evadys, Domino, Magelys, Eurorider, Ares 15 m	Ø 430	Euro 4, 5	Moteur Cursor 10F3AE
<b>67112</b>	Irisbus Recreo	Ø 400	Euro 4, 5	Moteur Tector BV 6S1200
<b>90188</b>	Irisbus Recreo, Crossway	Ø 400	Euro 6	Moteur Tector 7, Tector RV S6-1010
<b>66977</b>	Irisbus Tracer, Recreo	Ø 430	Euro 1, 2	Moteur Renault dep 01/93 Moteur MIDR 062045A MIDR 062045A41 MIDR 0620445A/3 B.V. G4061T PRAGA 5PS115R38
<b>MAN/NEOPLAN</b>				
<b>66975</b>	Man, Vanhool T8	Ø 420	Euro 0, 1	Moteur D2866UH, TOH, LOH, LXOH
<b>66976</b>	Man SU 313 (A72), Neoplan Lion's Regio, Lion's coach, Tourliner, Trendliner, Vanhool T8, T9	Ø 430	Euro 3	Moteur D2866LOH 01/02/03/06/07/09, D2866LUH20/21/22/26, D2876LOH01
<b>75168</b>	Man SU 263, Lion's Regio	Ø 430	Euro 3, 4	Moteur Man D0836 LOH01/02/03/04
<b>84937</b>	Man Lion's Regio	Ø 430	Euro 5	Moteur D0836LOH 51-58/62/63
<b>69028</b>	Man Lion's Regio, Lion's coach R07, R03	Ø 488	Euro 4	Moteur D2066LOH01-08/10-12, D2066LUH 01-05/07-09/11-18/21-24/26-28/41-43/47/48, D2876LOH 01-04/10
<b>69028</b>	Neoplan Cityliner, Tourliner, Trendliner	Ø 488	Euro 4, 5	Moteur D2066LOH01-08/10-12, D2066LUH 01-05/07-09/11-18/21-24/26-28/41-43/47/48, D2876LOH 01-04/10
<b>53293</b>	Man, Starliner	Ø 430	Euro 3	Bi-masse Moteur D2876 LOH03, LOH20, LOH34, LOH29

RÉF ATS	DÉSIGNATION	DIAMÈTRE	NORME	PARTICULARITÉS
<b>MERCEDES</b>				
<b>68416</b>	Mercedes Intouro 0560, Tourino 0510	Ø 395	Euro 4, 5	Moteur OM906LA, 926LA
<b>94848</b>	Multiclass, Comfort class 500, Turismo, Intouro, Integro	Ø 430	Euro 6	Moteur OM936LA
<b>66975</b>	Mercedes 0303, Setra 215	Ø 420	Euro 0	Moteur OM402, 403, 407, 421, 422, 423, 427
<b>66973</b>	Mercedes 0345, 0350, 0404, 0550 Integro, Setra 309HD, 315HD, HDH, 313-315UL, H, GTHD	Ø 430	Euro 2	Moteur OM401LA, OM402LA, 441LA, 442A, 442LA, 447HLA
<b>66974</b>	Mercedes 0345 Connecto S412-S416 UL - S312-S315 UL, H, GTHD	Ø 430	Euro 3, 4, 5	Moteur OM457HLA, OM457LA
<b>61185</b>	Mercedes 0580 Travego, S415, S416, 417 HD, HDH, S411 HD	Ø 430	Euro 3, 4	Non bi-masse Moteur OM501LA, 502LA V6, V8
<b>51319</b>	Mercedes 0350, 0580 Travego, Turismo New, Setra 415-417GTHD, 415-417HD, HDH	Ø 430	Euro 3, 4, 5	Bi-masse Moteur OM457 HLA, LA
<b>51746</b>	Mercedes Setra 411HD	Ø 430	Euro 3, 4	Bi-masse Moteur OM501 LA
<b>94835</b>	Comfort class 500, Top class 500, Turismo, Multiclass 400	Ø 430	Euro 6	Moteur OM470LA
<b>94847</b>	Comfort class 500, Top class 500, Turismo, Travego	Ø 430	Euro 6	Moteur OM471LA
<b>OTOKAR</b>				
<b>90750</b>	Otokar Vectio			Moteur D0836LOH51-58/62/63, D0836LOH40/41/50
<b>88015</b>	Otokar Navigo	Ø 362	Euro 5	Moteur Cummins
<b>SCANIA</b>				
<b>35659</b>	Scania K113, CLB, CLP, TLP, CLA, CRA 1ère génération	Ø 430	Euro 0, 1	Moteur DS9, DSC9, DSC11
<b>64742</b>	Scania Irizar Century PB, K124	Ø 430	Euro 2	Moteur DSC1202 véhicule sans EDC (HPI)
<b>50359</b>	Scania Irizar Century PB, K124	Ø 430	Euro 3	Moteur DC11 AVEC EDC, DC12.03/05
<b>77676</b>	Scania Irizar Century PB	Ø 430	Euro 4, 5	Moteur DC-DT 12
<b>VOLVO</b>				
<b>64744</b>	Volvo B12, B12B	Ø 430	Euro 1, 2	Moteur D12A
<b>90184</b>		Ø 430	Euro 3	Moteur D12A/B/C, DH12 C/D, DH12D
<b>90185</b>		Ø 430	Euro 4, 5	Moteur DH12E, D13C/F/H



DIMENSION	RÉF ATS OPTIBELT	RÉF ATS CONTITECH	RÉF ATS DAYCO
<b>1 - COURROIE TRAPEZOÏDALE ÉTROITE CRANTÉE</b>			
AV X 10 X 600	<b>483040</b>		
AV X 10 X 650	<b>468140</b>		
AV X 10 X 700	<b>468150</b>		
AV X 10 X 710	<b>468160</b>		
AV X 10 X 725	<b>468170</b>		
AV X 10 X 750	<b>483050</b>		
AV X 10 X 775	<b>483060</b>		
AV X 10 X 800	<b>483070</b>		
AV X 10 X 813	<b>477840</b>		
AV X 10 X 825	<b>398260</b>	<b>39826</b>	
AV X 10 X 850	<b>483080</b>		
AV X 10 X 875	<b>483090</b>		
AV X 10 X 900	<b>373310</b>	<b>37331</b>	
AV X 10 X 910		<b>37332</b>	
AV X 10 X 913	<b>373320</b>		
AV X 10 X 920	<b>373330</b>	<b>37333</b>	
AV X 10 X 925	<b>373340</b>	<b>37334</b>	
AV X 10 X 930	<b>373350</b>	<b>37335</b>	
AV X 10 X 935	<b>373360</b>	<b>37336</b>	
AV X 10 X 940	<b>373370</b>	<b>37337</b>	
AV X 10 X 950	<b>387350</b>	<b>38735</b>	
AV X 10 X 960	<b>387360</b>	<b>38736</b>	
AV X 10 X 965	<b>468180</b>		
AV X 10 X 975	<b>483100</b>		
AV X 10 X 1000	<b>483110</b>		
AV X 10 X 1013	<b>468560</b>		
AV X 10 X 1025	<b>489460</b>		
AV X 10 X 1050	<b>483120</b>		
AV X 10 X 1060	<b>483200</b>		
AV X 10 X 1075	<b>491400</b>		
AV X 10 X 1100	<b>436430</b>	<b>43643</b>	
AV X 10 X 1110	<b>483210</b>		
AV X 10 X 1125	<b>483130</b>		
AV X 10 X 1140	<b>483220</b>		
AV X 10 X 1150	<b>477830</b>		

DIMENSION	RÉF ATS OPTIBELT	RÉF ATS CONTITECH	RÉF ATS DAYCO
AV X 10 X 1175	<b>434220</b>	<b>43422</b>	
AV X 10 X 1200	<b>356240</b>	<b>35624</b>	
AV X 10 X 1225	<b>483140</b>		
AV X 10 X 1250	<b>483150</b>		
AV X 10 X 1275	<b>360480</b>	<b>36048</b>	
AV X 10 X 1300	<b>411650</b>	<b>41165</b>	
AV X 10 X 1325	<b>579390</b>		
AV X 10 X 1340	<b>52936</b>		
AV X 10 X 1350	<b>483160</b>		
AV X 10 X 1375	<b>436440</b>	<b>43644</b>	<b>67676</b>
AV X 10 X 1400	<b>483170</b>		<b>67678</b>
AV X 10 X 1425	<b>489470</b>		<b>67680</b>
AV X 10 X 1450	<b>477860</b>		<b>67681</b>
AV X 10 X 1475	<b>483180</b>		<b>67682</b>
AV X 10 X 1500	<b>483190</b>		<b>67683</b>
AV X 10 X 1525	<b>49339</b>		<b>67684</b>
AV X 10 X 1550	<b>362920</b>	<b>36292</b>	<b>67685</b>
AV X 10 X 1575	<b>53902</b>		<b>67686</b>
AV X 10 X 1600	<b>382770</b>	<b>38277</b>	
AV X 10 X 1625	<b>404290</b>	<b>40429</b>	<b>67687</b>
AV X 10 X 1650	<b>411660</b>	<b>41166</b>	<b>67688</b>
AV X 10 X 1700	<b>62596</b>		
AV X 10 X 1725	<b>49249</b>		
AV X 10 X 1750	<b>497200</b>		
AV X 10 X 1775	<b>401030</b>	<b>40103</b>	
AV X 11,5 X 685	<b>468190</b>		
AV X 11,5 X 730	<b>468200</b>		
AV X 11,9 X 1288		<b>91549</b>	
AV X 13 X 600		<b>35767</b>	
AV X 13 X 750	<b>53890</b>		
AV X 13 X 775	<b>357680</b>		
AV X 13 X 780		<b>35768</b>	
AV X 13 X 800	<b>354690</b>	<b>35469</b>	<b>67740</b>
AV X 13 X 813			<b>67741</b>
AV X 13 X 818	<b>374610</b>	<b>37461</b>	

DIMENSION	RÉF ATS OPTIBELT	RÉF ATS CONTITECH	RÉF ATS DAYCO
AV X 13 X 825	<b>350420</b>	<b>35042</b>	<b>67742</b>
AV X 13 X 835			<b>67743</b>
AV X 13 X 850	<b>350960</b>	<b>35096</b>	<b>67744</b>
AV X 13 X 860			<b>67745</b>
AV X 13 X 865			<b>67746</b>
AV X 13 X 875	<b>350430</b>	<b>35043</b>	<b>67747</b>
AV X 13 X 890			<b>67754</b>
AV X 13 X 900	<b>350440</b>	<b>35044</b>	
AV X 13 X 915			<b>67755</b>
AV X 13 X 925	<b>350970</b>	<b>35097</b>	<b>67756</b>
AV X 13 X 950	<b>350450</b>	<b>35045</b>	<b>67749</b>
AV X 13 X 960	<b>452750</b>		
AV X 13 X 965			<b>67750</b>
AV X 13 X 975	<b>351230</b>	<b>35123</b>	<b>67751</b>
AV X 13 X 1000	<b>350980</b>	<b>35098</b>	<b>67752</b>
AV X 13 X 1015	<b>76983</b>		<b>67753</b>
AV X 13 X 1025	<b>350100</b>	<b>35010</b>	<b>67757</b>
AV X 13 X 1030			<b>67758</b>
AV X 13 X 1035			<b>67759</b>
AV X 13 X 1040			<b>67760</b>
AV X 13 X 1050	<b>351770</b>	<b>35177</b>	<b>67761</b>
AV X 13 X 1055			<b>67762</b>
AV X 13 X 1060	<b>78643</b>		
AV X 13 X 1065			<b>67763</b>
AV X 13 X 1065			<b>70158</b>
AV X 13 X 1075	<b>351080</b>	<b>35108</b>	<b>67764</b>
AV X 13 X 1085			<b>67765</b>
AV X 13 X 1090			<b>67766</b>
AV X 13 X 1100	<b>350110</b>	<b>35011</b>	<b>67767</b>
AV X 13 X 1115			<b>67768</b>
AV X 13 X 1118	<b>350120</b>	<b>35012</b>	
AV X 13 X 1120			<b>67769</b>
AV X 13 X 1125	<b>350990</b>	<b>35099</b>	<b>67770</b>
AV X 13 X 1138		<b>43156</b>	
AV X 13 X 1140	<b>431560</b>		<b>67771</b>
AV X 13 X 1145			<b>67772</b>
AV X 13 X 1150	<b>351780</b>	<b>35178</b>	<b>67773</b>



1

DIMENSION	RÉF ATS OPTIBELT	RÉF ATS CONTITECH	RÉF ATS DAYCO
AV X 13 X 1155			67774
AV X 13 X 1165		67356	
AV X 13 X 1170			67775
AV X 13 X 1175	350130	35013	67776
AV X 13 X 1200	350140	35014	67777
AV X 13 X 1225	350150	35015	67778
AV X 13 X 1245			67779
AV X 13 X 1250	350160	35016	67780
AV X 13 X 1255			67781
AV X 13 X 1275	351000	35100	67782
AV X 13 X 1285	351330	35133	67783
AV X 13 X 1290	401010	40101	67784
AV X 13 X 1300	350170	35017	67785
AV X 13 X 1320			67786
AV X 13 X 1325	350180	35018	67788
AV X 13 X 1335			67789
AV X 13 X 1340			67790
AV X 13 X 1350	351010	35101	67791
AV X 13 X 1365			67792
AV X 13 X 1375	350190	35019	67787
AV X 13 X 1385			67793
AV X 13 X 1400	351020	35102	67794
AV X 13 X 1410		74315	67795
AV X 13 X 1425	350200	35020	67796
AV X 13 X 1430			67797
AV X 13 X 1444			67799
AV X 13 X 1450	351030	35103	67800
AV X 13 X 1460		48496	
AV X 13 X 1475	351040	35104	67801
AV X 13 X 1485	385050	38505	67802
AV X 13 X 1500	350210	35021	67803
AV X 13 X 1510			67804
AV X 13 X 1518	432120	43212	
AV X 13 X 1525	350220	35022	67805
AV X 13 X 1529			67806

DIMENSION	RÉF ATS OPTIBELT	RÉF ATS CONTITECH	RÉF ATS DAYCO
AV X 13 X 1535			67807
AV X 13 X 1550	350230	35023	67808
AV X 13 X 1575	350240	35024	67809
AV X 13 X 1600	351050	35105	67811
AV X 13 X 1615			67812
AV X 13 X 1625	350250	35025	67813
AV X 13 X 1650	350260	35026	67814
AV X 13 X 1665			67815
AV X 13 X 1675	350270	35027	67816
AV X 13 X 1700	350280	35028	67817
AV X 13 X 1715			67818
AV X 13 X 1725	350290	35029	67819
AV X 13 X 1750	350300	35030	67820
AV X 13 X 1775	351790	35179	
AV X 13 X 1800	350310	35031	67821
AV X 13 X 1825	350320	35032	67822
AV X 13 X 1850	351060	35106	67823
AV X 13 X 1860			67824
AV X 13 X 1875	351070	35107	67825
AV X 13 X 1880			67826
AV X 13 X 1900	350330	35033	67827
AV X 13 X 1925	350340	35034	67828
AV X 13 X 1950	350350	35035	67829
AV X 13 X 1975	350360	35036	67830
AV X 13 X 1980			67831
AV X 13 X 2000	350370	35037	67832
AV X 13 X 2020			67833
AV X 13 X 2025	350380	35038	
AV X 13 X 2050	350390	35039	67834
AV X 13 X 2075	374410	37441	67835
AV X 13 X 2100	350400	35040	67836
AV X 13 X 2125	361520	36152	67837
AV X 13 X 2130			67838
AV X 13 X 2150	74961		

DIMENSION	RÉF ATS OPTIBELT	RÉF ATS CONTITECH	RÉF ATS DAYCO
AV X 13 X 2200	376200	37620	
AV X 13 X 2225	351980		
AV X 13 X 2250			67841
AV X 13 X 2300	446590		67842
AV X 13 X 2325	472950		67843
AV X 13 X 2375			67845
AV X 13 X 2400		35041	67846
AV X 13 X 2425	489560		67839
AV X 13 X 2450	468590		67840
AV X 13 X 2475			67847
AV X 13 X 2500	468580		67848
AV X 13 X 2550			67849
AV X 13 X 2575	435290		
AV X 17 X 1040			81422
AV X 17 X 1080C			67598
AV X 17 X 1250		90258	
AV X 17 X 1626			78657
AV X 17 X 975	51524		
<b>2 - COURROIE TRAPEZOIDALE LISSE</b>			
AVP13 X 2050	478690		
AVP13 X 2100	62869		
AVP13 X 2150	356710	35671	
AVP13 X 2175		38079	
AVP13 X 2225		35292	
AVP13 X 2250	350020	35002	
AVP13 X 2300		35003	
AVP13 X 2325		35004	
AVP13 X 2350	350050	35005	
AVP13 X 2375	350060	35006	
AVP13 X 2400	477850	67585	
AVP13 X 2425	352930	35293	
AVP13 X 2450	350070	35007	
AVP13 X 2500	350080	35008	
AVP13 X 2550	350090	35009	

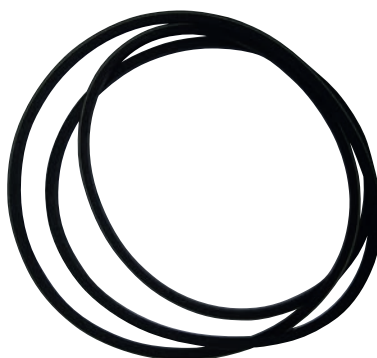

DIMENSION	RÉF ATS OPTIBELT	RÉF ATS CONTITECH	RÉF ATS DAYCO
AVP13 X 2575	<b>356870</b>	<b>35687</b>	
AVP13 X 2625		<b>35928</b>	
AVP13 X 2650	<b>355350</b>	<b>35535</b>	
AVP17 X 1250		<b>37387</b>	
3 - COURROIE TRAPEZOIDALE ETROITE CRANTÉE DOUBLE			
2AV X 10 X 1100	<b>64105</b>		
2AV X 10 X 1400	<b>63890</b>		
2AV X 10 X 1500	<b>65997</b>		
2AV X 10 X 1725	<b>57087</b>		
2AV X 13 X 1075	<b>421510</b>	<b>42151</b>	
2AV X 13 X 1150	<b>421830</b>	<b>42183</b>	
2AV X 13 X 1155	<b>77720</b>		
2AV X 13 X 1175	<b>421820</b>	<b>42182</b>	
2AV X 13 X 1200	<b>421810</b>	<b>42181</b>	
2AV X 13 X 1225	<b>73932</b>		
2AV X 13 X 1450	<b>495430</b>		
2AV X 13 X 1475	<b>44628</b>		
2AV X 13 X 1725	<b>86316</b>		
2AV X 13 X 1730	<b>61928</b>		
2AV X 13 X 1800	<b>85813</b>		
2AV X 13 X 1835	<b>421360</b>	<b>42136</b>	
2AV X 13 X 1950	<b>421710</b>	<b>42171</b>	
2AV X 13 X 1970	<b>70260</b>		
2AV X 13 X 2000	<b>421370</b>		
2AV X 13 X 2025	<b>60210</b>		
2AV X 13 X 2130	<b>61927</b>		
2AV X 13 X 2175	<b>82056</b>		
2AV X 13 X 2220	<b>421690</b>	<b>42169</b>	
2AV X 13 X 2300	<b>69</b>	<b>43919</b>	
2AV X 13 X 2325	<b>447700</b>		
2AV X 13 X 2425	<b>447710</b>		
2AV X 15 X 1820	<b>93195</b>		
2AV X 15 X 1990	<b>93198</b>		
2AV X 15 X 2020	<b>93199</b>		
2AV X 15 X 2110	<b>93200</b>		

DIMENSION	RÉF ATS OPTIBELT	RÉF ATS CONTITECH	RÉF ATS DAYCO
3AV X 10 X 1650	<b>73809</b>		
3AV X 13 X 2350	<b>82046</b>		
4 - COURROIE TRAPEZOIDALE			
B38	<b>74956</b>		
B42.5	<b>66091</b>		
B44	<b>66092</b>		
B48171270		<b>74305</b>	
B54	<b>407800</b>	<b>40780</b>	
B56	<b>419500</b>	<b>41950</b>	
B58	<b>403490</b>	<b>40349</b>	
B59	<b>73928</b>		
B61		<b>44864</b>	
B64		<b>43628</b>	
B70	<b>361500</b>	<b>36150</b>	
B71	<b>407810</b>	<b>40781</b>	
B73		<b>37138</b>	
B76		<b>51584</b>	
B81	<b>406970</b>	<b>40697</b>	
B85		<b>37677</b>	
B86	<b>51582</b>	<b>74139</b>	
B87		<b>44832</b>	
B90	<b>365320</b>	<b>36532</b>	
B93	<b>378420</b>	<b>37842</b>	
B94	<b>375190</b>	<b>37519</b>	
B94, 5	<b>378430</b>	<b>37843</b>	
B98	<b>403500</b>	<b>40350</b>	
B X 41	<b>62759</b>		
B X 55	<b>453500</b>		
B X 79	<b>439850</b>		
5 - COURROIE TRAPEZOIDALE			
SPA875	<b>351530</b>		
SPA1107	<b>404500</b>	<b>40450</b>	
SPA1157	<b>408510</b>		
SPA1307		<b>51657</b>	
SPA1382	<b>444080</b>	<b>44408</b>	
SPA1532	<b>406730</b>	<b>40673</b>	
SPA1582	<b>354800</b>	<b>35480</b>	

DIMENSION	RÉF ATS OPTIBELT	RÉF ATS CONTITECH	RÉF ATS DAYCO
SPA1607		<b>51656</b>	
SPA1700	<b>405110</b>	<b>40511</b>	
SPA1757	<b>409780</b>	<b>40978</b>	
SPA1832	<b>373730</b>	<b>37373</b>	
SPA1900	<b>90161</b>		
SPA1932	<b>49914</b>		
SPA2000	<b>66468</b>	<b>67586</b>	
SPA2057	<b>405450</b>	<b>40545</b>	
SPA2082	<b>397930</b>	<b>39793</b>	
SPA2120	<b>446980</b>	<b>39870</b>	
SPA2282	<b>351130</b>	<b>35113</b>	
SPA2300	<b>578620</b>	<b>53270</b>	
SPA2332	<b>398940</b>	<b>39894</b>	
SPA2482	<b>363090</b>	<b>36309</b>	
SPA2532		<b>51658</b>	
SPA2600	<b>374420</b>		
SPA2632	<b>50784</b>	<b>51654</b>	
SPA2682	<b>351140</b>	<b>35114</b>	
6 - COURROIE TRAPEZOIDALE			
SPB1250	<b>91485</b>		
SPB1320	<b>351610</b>	<b>35161</b>	
SPB1340	<b>389720</b>	<b>38972</b>	
SPB1400	<b>351520</b>	<b>35152</b>	
SPB1426	<b>71182</b>		
SPB1472	<b>92862</b>	<b>73877</b>	
SPB1478	<b>71181</b>		
SPB1550	<b>371270</b>	<b>37127</b>	
SPB1650	<b>73246</b>		
SPB1800	<b>91484</b>		
SPB1850	<b>52831</b>		
SPB1900	<b>351540</b>	<b>35154</b>	
SPB2000	<b>66078</b>	<b>67587</b>	
SPB2020		<b>35358</b>	
SPB2060	<b>474520</b>		
SPB2098	<b>372180</b>	<b>37218</b>	
SPB2120	<b>355730</b>	<b>35573</b>	
SPB2150	<b>361510</b>	<b>36151</b>	

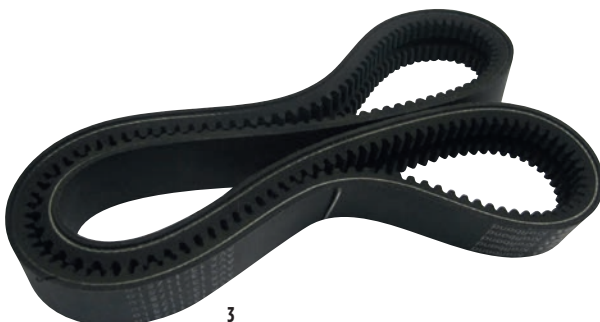

3



4



5

DIMENSION	RÉF ATS OPTIBELT	RÉF ATS CONTITECH	RÉF ATS DAYCO
SPB2200	<b>86173</b>		
SPB2280	<b>447160</b>		
SPB2300		<b>45003</b>	
SPB2310	<b>375440</b>	<b>37544</b>	
SPB2320	<b>472970</b>		
SPB2360	<b>465330</b>	<b>67588</b>	
SPB2400	<b>55615</b>		
SPB2410	<b>357690</b>	<b>35769</b>	
SPB2 X 2000		<b>44491</b>	
SPB2 X 2050	<b>456040</b>		
SPB2 X 2100	<b>421340</b>	<b>42134</b>	
SPB3 X 2100	<b>421680</b>	<b>42168</b>	
2SPB2000	<b>444910</b>		
2SPB2120	<b>77087</b>		
2SPB2240	<b>68312</b>		
2SPB2280	<b>62190</b>		
2SPB2400		<b>68311</b>	
3SPB2100	<b>62870</b>		
6 - COURROIE TRAPEZOIDALE			
SPZ750	<b>52055</b>		
SPZ1060	<b>73929</b>		
SPZ1650	<b>478250</b>		
SPZ1737		<b>52895</b>	
SPZ1762	<b>363750</b>	<b>36375</b>	
SPZ1800	<b>61288</b>		
SPZ2437		<b>43140</b>	
7 - COURROIE TRAPEZOIDALE			
X PA1030	<b>354600</b>	<b>35460</b>	
X PA1120	<b>364540</b>	<b>36454</b>	
X PA1210	<b>438140</b>	<b>43814</b>	
X PA1360	<b>364560</b>	<b>36456</b>	
X PA1400	<b>357930</b>	<b>35793</b>	
X PA1450	<b>478260</b>		
X PA1550		<b>40508</b>	
X PA1557	<b>53840</b>		
X PA1600	<b>364550</b>	<b>36455</b>	
X PA1800	<b>357940</b>	<b>35794</b>	

DIMENSION	RÉF ATS OPTIBELT	RÉF ATS CONTITECH	RÉF ATS DAYCO
X PA1900	<b>407310</b>	<b>40731</b>	
X PA2000	<b>478240</b>		
X PA2360		<b>44971</b>	
X PA832	<b>53267</b>		
8 - COURROIE TRAPEZOIDALE			
X PB1040	<b>84992</b>		
X PB1250	<b>512900</b>	<b>47856</b>	<b>67950</b>
X PB1320	<b>362700</b>	<b>36270</b>	<b>67951</b>
X PB1400	<b>53006</b>		<b>67952</b>
X PB1450	<b>63535</b>	<b>45144</b>	<b>67953</b>
X PB1455	<b>451270</b>	<b>67590</b>	<b>67954</b>
X PB1500	<b>351620</b>	<b>35162</b>	<b>67955</b>
X PB1525	<b>91586</b>		
X PB1550		<b>47855</b>	
X PB1590	<b>478270</b>		
X PB1600	<b>391800</b>	<b>39180</b>	<b>67956</b>
X PB1650		<b>85787</b>	
X PB1690	<b>405480</b>		
X PB1700	<b>404250</b>	<b>40425</b>	<b>67957</b>
X PB1750	<b>67223</b>	<b>67591</b>	
X PB1800	<b>478220</b>		<b>67958</b>
X PB1900	<b>352090</b>	<b>35209</b>	<b>67959</b>
X PB1950	<b>53999</b>	<b>67592</b>	
X PB1970	<b>62923</b>		
X PB2000	<b>360560</b>	<b>36056</b>	<b>67960</b>
X PB2020	<b>73218</b>		
X PB2040	<b>478230</b>		
X PB2082	<b>53007</b>		
X PB2120	<b>270820</b>	<b>27082</b>	<b>67961</b>
X PB2150	<b>413430</b>	<b>41343</b>	<b>67962</b>
X PB2240	<b>362860</b>	<b>36286</b>	<b>67963</b>
X PB2310	<b>522640</b>	<b>67594</b>	
X PB2325	<b>359290</b>	<b>35929</b>	<b>67964</b>
X PB2360	<b>376250</b>	<b>37625</b>	
X PB2375	<b>58296</b>	<b>67595</b>	
X PB2400	<b>55232</b>	<b>67596</b>	
X PB2445	<b>456790</b>		

DIMENSION	RÉF ATS OPTIBELT	RÉF ATS CONTITECH	RÉF ATS DAYCO
X PZ1120	<b>86169</b>		
X PZ1700	<b>396640</b>	<b>39664</b>	
X PZ2500		<b>79226</b>	
8 - COURROIE			
17 X 1040		<b>73890</b>	
17 X 1060		<b>74304</b>	
17 X 1200	<b>436270</b>	<b>43627</b>	
17 X 1215	<b>399420</b>	<b>39942</b>	
17 X 1350	<b>352890</b>	<b>35289</b>	
17 X 1400	<b>352900</b>	<b>35290</b>	
17 X 1500	<b>352910</b>	<b>35291</b>	
17 X 1625	<b>436280</b>		
17 X 1915	<b>86007</b>		
17 X 2200	<b>351150</b>	<b>35115</b>	
17 X 2240	<b>352940</b>	<b>35294</b>	
17 X 2388	<b>436610</b>		
17 X 2400	<b>405690</b>	<b>40569</b>	
9 - COURROIE			
2 X PA2225			<b>67852</b>
2 X PA2300			<b>67853</b>
2 X PA2325			<b>67854</b>
2 X PA2425			<b>67855</b>
2 X PB1230	<b>82040</b>		<b>67856</b>
2 X PB1426	<b>581320</b>		
2 X PB1478	<b>581310</b>		
2 X PB1500	<b>579270</b>		
2 X PB1650	<b>456600</b>		<b>67857</b>
2 X PB1700	<b>82039</b>		<b>67858</b>
2 X PB1739	<b>90381</b>		
2 X PB1782	<b>90380</b>		
2 X PB1800			<b>67859</b>
2 X PB1900	<b>452560</b>		
2 X PB1950		<b>79180</b>	
2 X PB2050	<b>478180</b>	<b>74301</b>	
2 X PB2100	<b>61631</b>		
2 X PB2140	<b>78662</b>		
2 X PB2240	<b>78094</b>		
2 X PB2400	<b>64653</b>	<b>56413</b>	



6



7

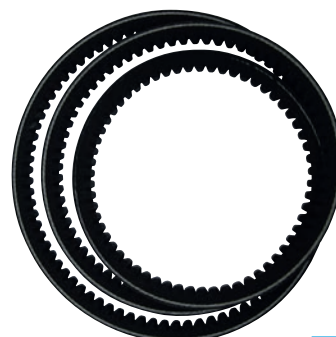

8

DIMENSION	RÉF ATS OPTIBELT	RÉF ATS CONTITECH	RÉF ATS DAYCO
<b>10 - COURROIE TRAPEZOIDALE À NERVURES</b>			
3PK515			<b>77425</b>
3PK630	<b>85314</b>		
3PK675	<b>468210</b>	<b>67482</b>	<b>67860</b>
3PK715	<b>468220</b>	<b>67483</b>	<b>67861</b>
3PK820	<b>468230</b>	<b>67484</b>	<b>67862</b>
4PK1010	<b>93194</b>		
4PK1025	<b>456660</b>		
4PK1028	<b>70264</b>	<b>67545</b>	
4PK1030	<b>475180</b>		
4PK1055	<b>62760</b>		
4PK1060	<b>71931</b>		
4PK1102		<b>74136</b>	
4PK1110	<b>66037</b>	<b>67485</b>	<b>67863</b>
4PK1125	<b>526790</b>	<b>67486</b>	<b>67864</b>
4PK1175	<b>90379</b>		
4PK1315	<b>93188</b>		
4PK698	<b>468240</b>	<b>67487</b>	<b>67865</b>
4PK715	<b>468250</b>	<b>67488</b>	<b>67866</b>
4PK775		<b>65420</b>	<b>67867</b>
4PK850	<b>468260</b>	<b>67489</b>	<b>67868</b>
4PK855	<b>468270</b>	<b>67490</b>	<b>67869</b>
4PK865	<b>468280</b>		
4PK875	<b>63958</b>	<b>67491</b>	<b>67870</b>
4PK890	<b>468290</b>	<b>67492</b>	<b>67871</b>
4PK997	<b>90378</b>		
5PK1025	<b>73869</b>		
5PK1100	<b>66279</b>	<b>67495</b>	<b>67872</b>
5PK1150		<b>73887</b>	
5PK1160	<b>63526</b>		
5PK1225	<b>60169</b>	<b>67496</b>	<b>67873</b>
5PK1230	<b>60187</b>	<b>67497</b>	<b>67874</b>
5PK1240	<b>60188</b>	<b>67498</b>	

DIMENSION	RÉF ATS OPTIBELT	RÉF ATS CONTITECH	RÉF ATS DAYCO
5PK1413		<b>74093</b>	
5PK1460	<b>526370</b>		
5PK1500	<b>73993</b>		
5PK1525	<b>551800</b>		
5PK1755	<b>54324</b>		
5PK1815		<b>65419</b>	<b>67875</b>
5PK1950	<b>464990</b>		
5PK655	<b>55806</b>	<b>67499</b>	
5PK690	<b>447720</b>	<b>44772</b>	
5PK698	<b>455770</b>	<b>67500</b>	<b>67876</b>
5PK775	<b>468300</b>	<b>67501</b>	<b>67877</b>
5PK875	<b>468310</b>	<b>67503</b>	<b>67878</b>
5PK886	<b>468320</b>		
5PK890	<b>468330</b>	<b>67504</b>	<b>67879</b>
5PK905	<b>448390</b>		
5PK906		<b>74302</b>	
5PK915			<b>69512</b>
5PK940	<b>464970</b>	<b>67505</b>	
5PK962	<b>468340</b>	<b>67506</b>	<b>67880</b>
5PK970	<b>353610</b>	<b>35361</b>	
6PK1000		<b>74313</b>	
6PK1015	<b>468400</b>	<b>67508</b>	
6PK1030	<b>92552</b>		
6PK1045	<b>468410</b>	<b>67510</b>	<b>67883</b>
6PK1055	<b>526780</b>		<b>67884</b>
6PK1065	<b>468420</b>	<b>67511</b>	<b>67885</b>
6PK1090		<b>79955</b>	
6PK1100	<b>468430</b>	<b>67513</b>	<b>67886</b>
6PK1110	<b>483030</b>	<b>67514</b>	
6PK1125	<b>468440</b>	<b>67515</b>	<b>67888</b>
6PK1130	<b>468450</b>	<b>67516</b>	<b>67889</b>
6PK1138	<b>468460</b>		
6PK1145	<b>468470</b>	<b>67517</b>	<b>67890</b>
6PK1150	<b>452770</b>		<b>67891</b>

DIMENSION	RÉF ATS OPTIBELT	RÉF ATS CONTITECH	RÉF ATS DAYCO
6PK1165	<b>526380</b>	<b>67518</b>	<b>67892</b>
6PK1180	<b>468480</b>	<b>67519</b>	<b>67893</b>
6PK1190	<b>468490</b>	<b>67520</b>	
6PK1200		<b>67521</b>	<b>67894</b>
6PK1205	<b>456830</b>		
6PK1215	<b>73927</b>		
6PK1217		<b>74137</b>	
6PK1240	<b>66066</b>	<b>67522</b>	<b>67895</b>
6PK1245	<b>63389</b>		
6PK1255	<b>362930</b>		<b>67896</b>
6PK1256		<b>36293</b>	
6PK1308	<b>60259</b>		
6PK1318		<b>76528</b>	
6PK1345	<b>73992</b>		
6PK1350	<b>464980</b>		
6PK1395	<b>75882</b>		
6PK1432		<b>71713</b>	
6PK1450	<b>468500</b>		<b>67897</b>
6PK1520	<b>403070</b>	<b>40307</b>	<b>67898</b>
6PK1540	<b>531130</b>		
6PK1570	<b>455790</b>		<b>67899</b>
6PK1580		<b>76905</b>	
6PK1610	<b>558000</b>		<b>67900</b>
6PK1613		<b>55388</b>	
6PK1620			<b>84714</b>
6PK1625	<b>73923</b>		
6PK1635	<b>468510</b>	<b>67524</b>	<b>67901</b>
6PK1660	<b>468520</b>	<b>67525</b>	<b>67902</b>
6PK1693		<b>43423</b>	
6PK1695	<b>434230</b>		
6PK1698		<b>74308</b>	
6PK1700	<b>468530</b>		
6PK1705		<b>67526</b>	<b>67903</b>
6PK1740	<b>468540</b>	<b>67528</b>	<b>67904</b>

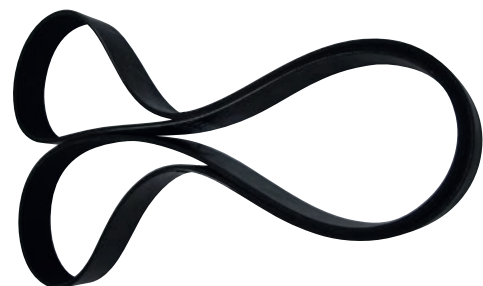

DIMENSION	RÉF ATS OPTIBELT	RÉF ATS CONTITECH	RÉF ATS DAYCO	DIMENSION	RÉF ATS OPTIBELT	RÉF ATS CONTITECH	RÉF ATS DAYCO	DIMENSION	RÉF ATS OPTIBELT	RÉF ATS CONTITECH	RÉF ATS DAYCO
6PK1863	74091			6PK950	70288			8PK1485	93189		
6PK1880	71645			6PK995	62313	57808		8PK1495	551910		67925
6PK1900	468550	67529	67905	7PK1215	456710			8PK1500	58249	67552	67926
6PK1965	456760	67530	67906	7PK1220	352950	35295	67881	8PK1535			92326
6PK2000	66532	67531	67908	7PK1350	454130	67543	67882	8PK1538		76286	
6PK2050	388510	38851	67909	7PK1388		72568		8PK1548	65004		
6PK2080	421840	42184	67907	7PK1453	73986			8PK1550	57680	67553	67927
6PK2100	388520	38852	67910	7PK1515	456680			8PK1570		73995	
6PK2140	447810			7PK1538		41488		8PK1580	85788		
6PK2145	421850	42185	67911	7PK1540	414880			8PK1600	70827		70826
6PK2150	388530	38853		7PK1549		73988		8PK1615	72879		
6PK2155		74138		7PK1570	428850	42885		8PK1625	533820	67554	
6PK2170	368480	36848	67912	7PK1793	91585			8PK1635	581300		67928
6PK2196		78034		7PK1970		71712		8PK1705	93190		
6PK2200	441220			7PK2035	79062	79151		8PK1715	85773		
6PK2205	73989	44122		7PK2350	472960			8PK1755	73931	74314	
6PK2215	62862	67532		7PK2355	472940			8PK1795	62921	67557	67929
6PK2225	78725			8PK1005	73883	73884		8PK1825	93191		
6PK2260	62448	67534		8PK1075	436450	43645		8PK1830	60186		
6PK2264		85694		8PK1135	71930			8PK1850	62863		67931
6PK2270	57304			8PK1158	73926	68170		8PK1875	539250		
6PK2280		67535	67913	8PK1215	64712	67547	67919	8PK1890		68404	73870
6PK2285	66948			8PK1230	533810	44974	67920	8PK1908			67932
6PK2300	50009		67914	8PK1275	65003	67548	67921	8PK1910	522170	67558	67933
6PK2330	427010	42701		8PK1332	72303			8PK1914	90062		
6PK2585	66533	67536	90928	8PK1365	69421			8PK1915	454140		
6PK737	468350	67537		8PK1371		76527		8PK1920	81353	90740	
6PK845	71078			8PK1376	73930	73922		8PK1930	560540		
6PK858	526750	67538	67915	8PK1400		82052		8PK1955		91691	
6PK875	580400	67539	67916	8PK1412		72892		8PK1956	93192		
6PK900	468360	67540	67917	8PK1420	61959	67549	67922	8PK1980		91551	
6PK906	468370	67541	67918	8PK1435	580480	67550	67923	8PK2000	62449	67559	
6PK913	468380			8PK1445	62861			8PK2035		67560	
6PK925	468390			8PK1480	62860	67551	67924	8PK2045	558130		

DIMENSION	RÉF ATS OPTIBELT	RÉF ATS CONTITECH	RÉF ATS DAYCO
8PK2050	465000	67561	
8PK2080	62857	67568	
8PK2114	421480		
8PK2130	62314	53060	67934
8PK2163		73958	
8PK2337		68969	
8PK2347	91540		
8PK2380	60912	67569	
8PK2425	68944		
8PK2465	73957		
8PK2513	90377		
8PK2560	74001		
8PK2605	62570		
8PK2638	73634		
8PK930TP15	79286		
8PK975	66593		
8PK980		73991	
9PK1200	63420	67571	67935
9PK1330	73999		
9PK1424	68475		
9PK1570	422360		
9PK1690	76937		
9PK1700	68057		
9PK1725	73563	74309	68092
9PK1780	452760	67573	67936
9PK1825	447940	43367	
9PK1826		74310	
9PK1881		73880	
9PK1888	447950		
9PK1910	58250	67575	67937
9PK1920		67576	67938
9PK1925	451670		
9PK1930	73886	73885	
9PK2000	60260		
9PK2010	478210	67577	67939
9PK2060	405390	40539	67940
9PK2080	419490	41949	67941
9PK2125	456770	67578	67942
9PK2200	415770	41577	
9PK2260	356800	35680	67943
9PK2285	514810		
9PK2295	382690	38269	67944
9PK2325	380690	38069	67945
9PK2550	62871	67584	

DIMENSION	RÉF ATS OPTIBELT	RÉF ATS CONTITECH	RÉF ATS DAYCO
9PK2580	395700	39570	67946
9PK2618	351600	35160	
9PK2642	377270	37727	67947
9PK4100	355460	35546	67948
9PK4145	351630	35163	67949
9PK4168	56490		
10PK1020			67689
10PK1042			67690
10PK1068			67691
10PK1108	66589	67447	67692
10PK1136			67693
10PK1145			67694
10PK1180	65652		
10PK1215	257160	25716	67695
10PK1240			67696
10PK1255			67697
10PK1300	62568		67698
10PK1350			67699
10PK1355			67700
10PK1370			67701
10PK1400			67702
10PK1440			67703
10PK1447		90250	
10PK1460			67704
10PK1500	67247		67705
10PK1512S			92328
10PK1520	441230		
10PK1535			67706
10PK1538		35112	
10PK1540	456610		67707
10PK1547			67708
10PK1556	86008		
10PK1570	422370	42237	
10PK1580	82038		
10PK1620			67709
10PK1630			67710
10PK1670	62864	67451	67711
10PK1675		76764	
10PK1680			67712
10PK1688		70588	
10PK1690	455780		67713
10PK1715			75931
10PK1725			67715
10PK1745	62567		

DIMENSION	RÉF ATS OPTIBELT	RÉF ATS CONTITECH	RÉF ATS DAYCO
10PK1768	454120		
10PK1800	64603		
10PK1805			67716
10PK1815	454160	67452	67717
10PK1830	70731		
10PK1845	78274		67718
10PK1850		73959	67719
10PK1860	69426		
10PK1863		74311	67720
10PK1930			67721
10PK1950			67722
10PK1980	62569		67723
10PK2050	474800		67724
10PK2063	447500	41635	
10PK2100	496790		
10PK2108	692050		67725
10PK2151	93193		
10PK2164	93186		
10PK2225	65653		
10PK2240	45448	67455	67726
10PK2253	93187		
10PK2335	539260		
10PK2470	78345		
11PK1420			67727
11PK1470			67728
11PK2015	456780		67729
11PK2020		78668	
11PK2040	526310	67462	67730
11PK2055	62875	67480	
11PK2835			67731
12PK1630			67732
12PK1814			67733
12PK1818			67735
12PK1830			67734
12PK1835			67736
12PK2230			67737
12PK2500	547470		67738
15PK938			67850
15PK954			67851

MODÈLE	TYPE MOTEUR	POULIE ENTRAÎNEMENT ALTERNATEUR 1	POMPE À EAU	CLIM	DAMPER/ POMPE HYDRAULIQUE OU RENVOI	CLIM ALTERNATEUR 2	VENTILATEUR	ALTERNATEUR 1
<b>BMC</b>								
Probus Euro 4 221 CV	Cummins		65389	350320	80558		76587 X 2	
Probus Euro 5 285 CV	Cummins		70827	80205	80193 X 2	351770 X 2	80192 X 2	
Alyos Euro 4 250 CV	Cummins		65389		76588 X 2		76587 X 2	
Alyos Euro 5 285 CV	Cummins		70827		80192		80193 X 2	
Midilux Euro 4 185 CV	Cummins		80846					
215 SCB Euro 4, 5			65389	67832	76588		76587 X 2	
<b>BOVA - VDL</b>								
Futura FHD Euro 0, 1	WS268M	421370		35358		351770	468580	
Futura Euro 3 Dep 2002 jsq 2004	XE		421480	53007		350100		351080
Futura Euro 5 DAF	PR265		75084	67774			41343	
Futura Euro 4	DAF MX		57716	468580		77720		
FLD 13	XE250C1		421480	413430 X 2				
<b>EOBUS MERCEDES</b>								
0345 Euro 2	OM447HLA	350140	350160 X 2		447710		351040	
0350 Euro 2	OM442LA	355460		74301				
0350 Euro 3	OM457LA		447950		82040		82039	350450
Connecto Euro 3	OM457HLA	60260		447940				
0550 Euro 1, 2	OM441LA		355460	356800 jsq 12/95				350450 X 2
0550 Euro 2 sans clim	OM447HLA	351780	35016		80690 dep 01/96		447700	
0550 Euro 3 avec clim	OM457HLA	351010	47821		456600	452750		
Tourismo New Euro 5	OM457LA		60260			60259	456600	62313
Tourismo New Euro 6	OM470	93188 L 1315	90377 L 2513	93186 L 2164		90378 L 997	90380 L 1782	
Intouro Euro 4	OM926LA	581300	454140	581300	71182 X 2		71181 X 2	
Intouro Euro 5	OM926LA	522170	454140	522170	71182 X 2		71181 X 2	
Intouro Euro 6	936LA	90379 L 1175	93192 L 1956	93193 L 2151		90378 L 997	90381 L 1739	
Tourino 0510	OM926LA Euro 4	581300			71182 X 2		71181 X 2	
<b>EOBUS SETRA</b>								
309HD	OM441LA		74961 X 2	446590				350430
315HD	OM442LA			82046	350310		351030	350430
315NF Euro 2	OM447HLA		421810		456790 X 2	452760 dep 08/96	451270 X 2	350160
315UL Euro 3	OM457HLA	351010	47821		456000	452750		
415NF	OM457HLA	73563 L 1728 456780 L 2017		526310				
411HD	OM501LA		547470	419490			478180	
415GTHD	OM457LA	60260		447940			478180	62313
415-416UL 1 alternateur	OM457HLA		452760				456600	
415-416UL 2 alternateurs	OM457HLA	60259	60260				456600	62313
<b>FAST</b>								
Scoler 2 Euro 3	DCI6		35100 X 2				351010	
Scoler 3 Euro 4 Châssis A91	D0836LOH51 58/62/63	65004		82038				
Scoler 4 - Châssis Renault	DXI7		75931					

MODÈLE	TYPE MOTEUR	POULIE ENTRAÎNEMENT ALTERNATEUR 1	POMPE À EAU	CLIM	DAMPER/ POMPE HYDRAULIQUE OU RENVOI	CLIM ALTERNATEUR 2	VENTILATEUR	ALTERNATEUR 1
Starter 3 Euro 4 Châssis A91	D2066LUH01 05/07/09/11 18/21-24/26 - 28/41 43/47/48		73926 L 1158	455780 L 1690	71645 L 1880			
Starter LE - Châssis A69	D0836LOH60/61	73809	65004 L 1548	82038 L 1580				
Syter A51	D2866LOH20 26/30/31	73809						
<b>HEULIEZ</b>								
GX137			93333					
<b>IVECO/IRISBUS</b>								
Midys / Midway Euro 3	Tector	581300		350160 X 2			350260 X 2	
Tracer	Renault							352950
Recreo Euro 2	Renault							257160
Axer/Recreo Euro 3	Cursor F2BE	474800 L2050						
Recreo New Euro 4, 5	Tector F4AE	581300	65617	352090	67598			
Recreo New, Crossway clim Spheros	Cursor 8		675450 X 2	62923 X 2				55388
Recreo New, Crossway, clim Thermoking	Cursor 8		67545	73218 X 2				55388
Crossway Euro 6	Cursor 9		93465 L 1010	93458 L 1714				
Crossway Euro 6	Tector 7		93333		67598			
Crossway LE Euro 6	Tector 7		93333	94418	67598			
Ares clim Thermoking Euro 3	Cursor F2B	474800		67558				
Ares Euro 2 sans clim	MIDR Renault	441230						447720
Ares DCI Euro 3 clim Bock alternateur 140 A + 80 A	DCI 11	434230		35162 X 2	35162 X 2 renvoi			448390
Arway Euro 4	Cursor F2BE 0682	55388	70264					
Iliade TE/TEC/RT/RTC clim GM alternateur Lucas	MIDR	456100		35016 X 2		353610		
Iliade RTX/GTX/TEX alternateur Bosch clim Bock	MIDR	403070		35162 X 2			351620	
Iliade Euro 3 clim Thermoking	DCI 11			351620 X 2		448390	351620 X 2	455780
Evadys H Euro 5	Cursor F2BE 682	55388	70264					
Magelys Euro 5	Cursor 10		62760 L 1055	53999 X 2 L 1950		71930 L 1135		72892 L 1412
Magelys HD Euro 6	Cursor 9		93465	93458 L 1714				93460 L 1803
Urbanway Euro 6	Tector 6		93333	67598				
<b>KING LONG</b>								
XMQ6800	Cummins		81072			67750 L 965		
XMQ6900	Cummins		81072					
<b>OTOKAR</b>								
Navigo	Cummins		70827					
Vectio Euro 5	Man D0836LOH		65004	403070			65003	

MODÈLE	TYPE MOTEUR	POULIE ENTRAÎNEMENT ALTERNATEUR 1	POMPE À EAU	CLIM	DAMPER/ POMPE HYDRAULIQUE OU RENVOI	CLIM ALTERNATEUR 2	VENTILATEUR	ALTERNATEUR 1
<b>TEMSA</b>								
MD9	Man D0836 Euro 5		65004			36286	456790	67708
Box Tourmalin Euro 3	DAF PE	77720	55192	78662				
Tourmalin Euro 4	DAF PR	77720	57716	78662				
Tourmalin Euro 5	Cummins		77159	352090 X 2			352090 X 2	
Safari Euro 3	Man D2866LOH28		350350	444910				
Safari HD	DAF XE315C	351080 X 2	421480	78662				
Safari Euro 4	Man D2066	539260		78662				539250
Safari Euro 4	DAF MX340		68475		64864			
Safari RD Euro 4	DAF PR	77720	57716	78662				
Safari Euro 4	MX300	64864	68475					
<b>VANHOOL</b>								
T9 Acron Euro 2	Man D2866LOH23		233500	358780			357930	
T9 TL Euro 2	Man D2866LOH25		233500	358780	357940	49762	357930	
T9 CL Euro 2	D2866LUH20	364540	56734		364550		364560	
T9 TL Euro 3	Man D2866LOH27		233500	358780	357940	49762	357930	
T9 Altano 460cv	D2876LOH01	40716	233500	358780		351780	41259	
T9 Euro 3 Acron	DAF XE315C1		421480	358780	40716	351780	41259	
T9 Euro 4 - 2 alternateurs 120A	Man D2066LOH		539250					
T9 Astronef Euro 4	DAF MX340U1	55937 L 1824	68475 L 142	66813 L 2280	478270 L 1590		405480 L 1690 X 2	350150 L 1225
T9 Astron Euro 4	DAF MX300U1	55937 L 1824	68475 L 1424	66813 L 2280	478270 L 1590		405480 L 1690 X 2	350150 L 1225
T9 Euro 5	DAF MX340U1	64864	68475					
TX Acron Euro 5	DAF MX300U1	64864		66813	478270		404250 X 2	
<b>VOLVO</b>								
9700 Euro 6	D11	93189 L 1485	93189 L 1485					
9700, 9900	D13	73870 L 1885						
B9R, B9L 2 alternateurs 2 X 110A	D9B	82052 L 1400						
7700 alternateur 115A, 180A	D7C	61927 L 2130						
B12M		69426 L 1863						
B9L, 7900	D9B	69421 L 1365						
<b>YUTONG</b>								
ZK6121HQ	Cummins ISL Euro 5		93450 L 1815	93202 L 1145	93195 L 1820		93199 L 2020	
ZK6121HQ EC12	DAF MX11		94419 L 2250				93205 L 2020	
XMQ6120	Cummins ISL 8, 9 Euro 5		93450 L 1815		93204 L 1705	67759 L 1035	93205 L 1830	
XMQ6127	Cummins ISL 8, 9 Euro 5		94450 L 1815		93205 L 1705	35010 L 1025		

## Cummins, BMC, Otokar, Tamsa

RÉF ATS	DÉSIGNATION	APPLICATION	
<b>76431</b>	Galet tendeur	BMC Probus, Tamsa Tourmalin Moteur ISBE6, 7	
<b>76429</b>	Galet pompe à eau	BMC Probus, Tamsa Tourmalin Moteur ISBE6, 7	
<b>76430</b>	Galet	BMC Probus, Tamsa Tourmalin Moteur Cummins ISBE6, 7	
<b>90076</b>	Galet tendeur	Otokar Navigo, moteur ISBE4, 5	
<b>90077</b>	Galet moteur Cummins		NR
<b>90078</b>	Arbre d'entraînement	Navigo Moteur ISBE4, 5	NR





## DAF

RÉF ATS	DÉSIGNATION	APPLICATION	
<b>76362</b>	Galet	Bova Moteur DAF	
<b>57213</b>	Galet	Bova Moteur DAF Euro 3	
<b>86443</b>	Galet Ø 77,95 - H1 38,85 - H2 119,83	VDL Bova, Vanhool, Tamsa Moteur DAF MX340S	
<b>68393</b>	Galet	Vanhool T9 Moteur DAF MX300S1, MX300U1 - Euro 4, 5	
<b>72473</b>	Galet tendeur	Moteur DAF MX300V1, MX300S1 - Euro 4, 5 (1 par véhicule)	
<b>71515</b>	Galet tendeur	Moteur DAF MX300V1, MX300S1 - Euro 4, 5 (1 par véhicule)	

### DAF

RÉF ATS	DÉSIGNATION	APPLICATION	
<b>61422</b>	Tendeur	Bova Futura Euro 3 Moteur XE280C, XE315C	
<b>57208</b>	Galet Ø 70	Bova FHD Euro 3, Vanhool T9 Moteur DAF XE280C, XE315C	
<b>77116</b>	Galet Ø ext 90 mm - L32 mm	Solaris Urbino 15, 18 Moteur XE250C, PE228C, PR265S, MX340, XE350C, MX265, XE315C, MX300	
<b>67423</b>	Tendeur 77 X 32,5 X 103	Bova FHD 12, 13, 15 - Magiq, Synergy, Vanhool T9 Moteur XE280C, XE315C	
<b>61530</b>	Tendeur	Bova Lexio, Temsa Box Moteur PE265C	
<b>94675</b>	Tendeur	Temsa Safari, Temsa LC 12, 13, Vanhool TX, EX, Yutong EC12, 13, VDL Futura FMD2, FHD2 Moteur MX11 Euro 6	
<b>94676</b>	Galet	Temsa Safari, Temsa LC 12, 13, Vanhool TX, EX, Yutong EC12, 13, VDL Futura FMD2, FHD2 Moteur MX11 Euro 6	
<b>94677</b>	Galet	Temsa Safari, Temsa LC 12, 13, Vanhool TX, EX, Yutong EC12, 13, VDL Futura FMD2, FHD2 Moteur MX11 Euro 6	

### Evobus

RÉF ATS	DÉSIGNATION	APPLICATION	
<b>50054</b>	Support tendeur de courroie	Evobus, Neoplan Moteur OM401LA, 402LA, 441LA, 442LA	
<b>57366</b>	Vérin tendeur	Evobus, Neoplan Moteur OM401LA, 402LA, 441LA, 442LA	
<b>49271</b>	Galet de courroie lisse Plastique Ø ext 100 - Ø int 40	0350, 0580	
<b>73908</b>	Galet de courroie lisse Acier Ø ext 100 - Ø int 40	Moteur OM401LA, 402LA, 441LA, 442LA	

## Evobus

RÉF ATS	DÉSIGNATION	APPLICATION	
<b>64821</b>	Galet de courroie avec gorge Plastique Ø ext 100 - Ø int 40	Moteur OM401LA, 402LA, 441LA, 442LA	
<b>64822</b>	Tendeur de courroie Ø ext 74 - l 42,5	0345 Citaro, 0510 Tourino, 0814, 0815, 0818 Vario Moteur OM457.933-935, 937, 942, 943, 960 OM906.940, 941-951, 952, 961, 962, 976 OM904LA, 926LA	
<b>50038</b>	Galet creux 80 X 47	0555 Euro 3 Integro, 315UL, NF Euro 3, Citaro Moteur OM457HLA, 457-933, 935, 937, 939, 940	
<b>64823</b>	Galet creux 74 X 38	0550, 0580, Setra série 400 Moteur OM457.936, 937, 940, 947, 960	
<b>64825</b>	Galet creux	0580, Setra série 400 Moteur OM501LA, 502LA	
<b>66942</b>	Tendeur de courroie Galet creux Ø 80 - l 33,5	0350 Turismo, 0580 Travego, Setra série 4 Moteur OM457.933, 934, 935, 942	
<b>61543</b>	Tendeur de courroie	Citaro Euro 3, 0345 Euro 3 dep 11/2011, Turismo, Travego, 0510 Tourino, 0520 Cito, 0560 Intouro, Setra série 400 Moteur OM457.942, 934, 937, OM457LA, OM926LA	
<b>66944</b>	Galet de courroie Linnig 95 X 39	0580 Travego, 0345 Connecto, 0530 Citaro, Setra série 4 Moteur OM457.941, 936, 944, 942, 938, 934	
<b>56073</b>		Setra série 4 Moteur OM502	
<b>64824</b>	Tendeur de courroie Ø ext 74 - l 38	0350 Turismo, 0580 Travego, Setra série 4 Moteur OM457.944, OM457.941	

### Evobus

RÉF ATS	DÉSIGNATION	APPLICATION	
<b>64829</b>	Galet tendeur Ø ext 74 - l 40	0350 Turismo, 0580 Travego, Setra série 4 Moteur OM457.940, 944, 941, 936, 938	
<b>62816</b>	Galet tendeur Ø ext 80 - l 47,5	Tourismo, Travego, Setra série 400 Moteur OM457LA	
<b>51463</b>	Poulie de renvoi Acier Climatisation Ø int 100 - Ø ext 80 - l 48 mm	Tourismo, Travego, Tourino 0510, Setra série 400 Moteur OM457LA, OM926LA	
<b>49274</b>	Galet tendeur Ø ext 74 - l 42	Citaro, Connecto, Tourino, Intouro Moteur OM926LA, OM457HLA	
<b>65763</b>	Poulie de renvoi Ø ext 75 - Ep 32,5	Intouro, Vario, Mediano OM457LA, HLA, OM926LA, OM904LA	
<b>93751</b>	Galet tendeur	Intouro, Comfortclass 500, Multiclass 400, Tourismo K OM936LA Euro 6	NR
<b>93752</b>	Galet	Intouro, Comfortclass 500, Multiclass 400, Tourismo K OM936LA Euro 6	NR
<b>93753</b>	Galet	Intouro Comfortclass 500, Multiclass 400, Tourismo K OM936LA Euro 6	
<b>71836</b>	Poulie support alternateur 9 gorges Ø ext 82 - l 36,6	Setra série 400 Moteur OM457LA	
<b>67216</b>	Galet lisse Climatisation Ø int 10 - Ø 80 - l 48	Setra 415-416NF Moteur OM457HLA	
<b>65762</b>	Galet tendeur Métallique Climatisation	Tourino 0510 Euro 4, Cito, Citaro, Intouro Moteur OM926LA, OM906LA	

## Evobus

<b>RÉF ATS</b>	DÉSIGNATION	APPLICATION	
<b>73910</b>	Galet tendeur Ø 74 - l 34	Vario 0814, 0815, 0818 Moteur OM904LA	
<b>RÉF ATS</b>	DÉSIGNATION	APPLICATION	
<b>73961</b>	Galet plastique Ø int 10 - l 44 int - l 80 ext	Vario 0814, 0815, 0818 Moteur OM904LA	
<b>RÉF ATS</b>	DÉSIGNATION	APPLICATION	
<b>41690</b>	Lever tendeur	OM 602.980	
<b>41691</b>	Axe lever tendeur	Sprinter 212, 312, 412, 410, 310 et 210 D Moteur 2,9L	
<b>RÉF ATS</b>	DÉSIGNATION	APPLICATION	
<b>36965</b>	Galet lisse 80 X 25/31	Sprinter 208, 308, 210, 310, 410, 212, 312, 412 D - Moteur OM602.980, OM601.943	
<b>RÉF ATS</b>	DÉSIGNATION	APPLICATION	
<b>50055</b>	Tendeur de courroie Ø ext 70 - Ep 27	Sprinter CDI châssis 901, 902, 903, 904 jsq 05/2006 Sprinter CDI châssis 906 dep 06/2006 OM 611.981, OM 611.987, OM 646 DELA, OM 642, OM 612.981	
<b>RÉF ATS</b>	DÉSIGNATION	APPLICATION	
<b>66736</b>	Poulie Ø int 17 - l 23	Sprinter 209, 309, 509 CDI 211, 311, 511 CDI 215, 315, 515 CDI 211, 311, 411 213, 313, 413 216, 316, 416 Moteur OM611LA, OM646DELA, OM642	
<b>RÉF ATS</b>	DÉSIGNATION	APPLICATION	
<b>64827</b>	Tendeur de courroie	Sprinter 309 CDI, 311 CDI, 315 CDI, 509 CDI, 511 CDI, 515 CDI	
<b>RÉF ATS</b>	DÉSIGNATION	APPLICATION	
<b>66011</b>	Galet Ø ext 65 - l 30	Sprinter 318 CDI, 518 CDI, 319, 419, 519 CDI Moteur OM642	
<b>RÉF ATS</b>	DÉSIGNATION	APPLICATION	
<b>57865</b>	Poulie de renvoi 6 gorges Climatisation Ø ext 109 - l 23	Sprinter 311, 313, 315 CDI 511, 513, 515 CDI Moteur OM646 DELA	



### Evobus

RÉF ATS	DÉSIGNATION	APPLICATION	
<b>89990</b>	Galet Ø 65,13	Galet Sprinter, Transfer 310, 313, 316 CDI dep 03/09 - 510, 513, 516 CDI dep 03/09 - Vito 110, 113, 116 CDI dep 09/10 Moteur OM651	
<b>79063</b>	Tendeur de courroie Ø ext 70 - l 20	Sprinter 319, 419, 519 CDI dep 03/09	
<b>84813</b>	Galet Climatisation l 65 ext - l 26 int	Sprinter, Transfer 516 CDI dep 03/09 Moteur OM651	
<b>77377</b>	Galet Ø 54 - l 30	Sprinter 218, 219 CDI - 318, 319 CDI - 518, 519 CDI V6 dep 06/06 Moteur OM642	
<b>77375</b>	Tendeur Ø 70 H1 26 - H2 53	Sprinter 218, 219 CDI - 318, 319 CDI - 518, 519 CDI V6 dep 06/06 jsq 02/09 Moteur OM642	
<b>77378</b>	Poulie Ø int 16 - Ø 80 - l 26	Sprinter 218, 219 CDI - 318, 319 CDI - 518, 519 CDI V6 dep 06/06 Moteur OM642	
<b>77379</b>	Poulie à nervures Ø 96 H1 20 - H2 25,2	Sprinter 211, 215, 216 CDI 311, 315, 316 CDI 511, 515, 516 CDI Moteur OM646DELA	
<b>77382</b>	Poulie alternateur 8 gorges Ø 79 - profondeur 39,8	Vario, Mediano 0814, 0815 Moteur OM904LA	
<b>77381</b>	Poulie alternateur	Vario, Mediano 0814, 0815 Moteur OM904LA	
<b>77383</b>	Poulie alternateur Ø ext 48,5 - Ep 45 mm - H 50	Sprinter dep 06/06 Moteur OMDELA, OM642 sur alternateur Valeo 14V 180A	

## Evobus

RÉF ATS	DÉSIGNATION	APPLICATION	
<b>61403</b>	Poulie alternateur 6 gorges Ø int 17 - Ø ext 50 - H 39	Sprinter dep 06/06, 318, 518 dep 03/06, Sprinter 315, 516 CDI dep 03/09 Moteur OM642, OM651, sur alternateur Bosch 14 V 200A	
<b>89832</b>	Tendeur Ø 65,10 H1 26,20 - H2 95,5	Sprinter, Transfer 310, 313, 316 CDI dep 03/09 510, 513, 516 CDI dep 03/09 - 410, 413, 416 CDI dep 03/09 - Vito 110, 113, 116 CDI dep 03/10 Moteur OM651	
<b>94833</b>	Galet Ext Ø 70 mm L 34 mm (2 par véhicule)	Tourismo Top Class 500 Comfort Class 500 OM470LA, OM471LA Euro 6	
<b>94834</b>	Poulie de renvoi	Tourismo Top class 500 Comfort class 500 OM470LA, OM471LA Euro 6	NR
<b>94832</b>	Tendeur courroie	Tourismo Topclass 500 Comfort class 500 OM470LA, OM471LA Euro 6	

## Iveco

RÉF ATS	DÉSIGNATION	APPLICATION	
<b>64831</b>	Poulie de renvoi Ø ext 74 - I 47	Ares, Evadys, Recreo, Axer Euro 3 Moteur Cursor F2B	
<b>66490</b>	Galet tendeur	GX117, Midway, Midys, Recreo, Crossway Euro 4, 5, Citelis hybride Moteur Tector F4AE	
<b>67041</b>	Poulie renvoi inférieur	Urbanway, Recreo, Crossway Euro 4, 5, 6 Citelis hybride GX117/127/137/327/337/427/437 Moteur Tector 6, 7	

### Iveco/Irisbus

RÉF ATS	DÉSIGNATION	APPLICATION	
<b>93335</b>	Galet	Crossway LE, Urbanway, GX337/137 Tector 7 Euro 6 (2 par véhicule)	NR
<b>66489</b>	Poulie tendeur supérieur	GX117, 127, Midway, Midys, Recreo, Citelis hybride Moteur Tector F4AE	
<b>52641</b>	Galet tendeur Plastique	GX317 Moteur Cursor F2BE	
<b>64833</b>	Galet tendeur Métallique		
<b>66488</b>	Poulie de tendeur Métallique	GX317, 327, 427, Recreo New, Crossway, Evadys H Euro 4, 5, Crealis, Citelis, Arway Euro 4 Moteur Iveco	
<b>64834</b>	Tendeur de courroie Ø ext 74 - I 46	Cityclass, Eurorider, Euroclass, Recreo, Axer, Ares Euro 3 Moteur Iveco	
<b>64830</b>	Galet tendeur Métallique Ø 70 - I 25	Cityclass, Euroclass, Eurorider, GX317, 327, 427, Recreo New, Crossway, Citelis, Evadys H, Crealis, Arway Euro 4 Moteur Iveco	
<b>81158</b>	Galet Climatisation	Agora	
<b>81156</b>	Poulie 2 gorges Climatisation	Agora, Citelis	
<b>72980</b>	Poulie alternateur	Recreo, Crossway, GX327 hybride, Citelis hybride Moteur Tector F4AE	
<b>93334</b>	Tendeur de courroie	Arway cursor 9, Magelys Euro 6 Crossway LE Euro 6 Cursor 9 Crosswat LE Euro 6 Tector 7 GX337/137 Urbanway	

## Iveco/Irisbus

RÉF ATS	DÉSIGNATION	APPLICATION	
<b>66611</b>	Tendeur de courroie	Evadys HD, Domino HD, HDH, Magelys HD, Arway 15m Moteur Cursor 10 F3AE0682	
<b>70263</b>	Tendeur de courroie Climatisation	Evadys HD, Magelys HD, HDH, Domino HD, HDH, Euro 5, 6 Arway 15 m Moteur Cursor 10 F3AE0682, Cursor 9	
<b>70262</b>	Poulie de renvoi	Evadys HD, Domino HD, HDH, Arway 15 m Moteur F3AE0682	
<b>93457</b>	Galet 3 par véhicule	Magelys Euro 6 Moteur Cursor 9	
<b>93334</b>	Tendeur de courroie	Magelys Euro 6 Moteur Cursor 9	
<b>72894</b>	Poulie tendeur	Iveco Daily 3 dep 05/06 Moteur F1CE0481HC, F1CE0481FA	
<b>75163</b>	Tendeur de courroie	Iveco Daily 3 dep 05/06 Moteur F1CE0481FA, F1CE0481HA	
<b>72896</b>	Tendeur de courroie Ø ext 67 - l 34 - l 49,9	Master, Daily 2 dep 11/01 jsq 04/06 Moteur 8140.43N, 8140.43S	
<b>70547</b>	Poulie tendeur Ø 65,3 - l 23,3	Mascott dep 01/99 jsq 06/04, Iveco Daily 2 dep 05/99 Moteur 8140.43N, 8140.43S, 8140.43C	
<b>72900</b>	Poulie de renvoi Ø 69,7 - l 24,8	Daily 2 dep 05/99 jsq 04/06 Moteur 8140.63, 8140.67, 8140.43N, 8140.431	

RÉF ATS	RÉF ORIGINE	DÉSIGNATION	APPLICATION
<b>84613</b>	<b>503142101</b>	Kit galet tendeur courroie 2 alternateurs 140A + 80A	Crossway, Crossway HV, Crossway LE, Recreo, Arway, Evadys H Euro 4, 5 moteur F2B Citelis 10,5 m-12 m-18 m Euro 4, 5 moteur F2B
DÉTAILS DU KIT			
RÉF ATS	RÉF ORIGINE	DÉSIGNATION	QTÉ
<b>85280</b>	<b>16691224</b>	Vis tête cylindrique	3
<b>85281</b>	<b>16692524</b>	Vis tête cylindrique	1
<b>85282</b>	<b>17221710</b>	Goupille ajustée	1
<b>77685</b>	<b>17800574</b>	Rondelle	1
<b>67545</b>	<b>504032641</b>	Courroie pompe à eau	1
<b>55388</b>	<b>504032643</b>	Courroie alternateur	1
<b>64830</b>	<b>504106749</b>	Galet tendeur	1
<b>66488</b>	<b>504106751</b>	Galet tendeur	1
<b>64833</b>	<b>504153873</b>	Galet tendeur	1



RÉF ATS	RÉF ORIGINE	DÉSIGNATION	APPLICATION
<b>84612</b>	<b>503142097</b>	Kit galet tendeur courroie 2 alternateurs 90A + 90A	Citelis Euro 3 moteur F2B Citelis 12M Euro 4 moteur F2B Crossway, Recreo Euro 4, 5 moteur F2B
DÉTAILS DU KIT			
RÉF ATS	RÉF ORIGINE	DÉSIGNATION	QTÉ
<b>85280</b>	<b>16691224</b>	Vis tête cylindrique	3
<b>85281</b>	<b>16692524</b>	Vis tête cylindrique	1
<b>85282</b>	<b>17221710</b>	Goupille ajustée	1
<b>77685</b>	<b>17800574</b>	Rondelle	1
<b>67545</b>	<b>504032641</b>	Courroie pompe à eau	1
<b>455790</b>	<b>504032642</b>	Courroie	1
<b>64830</b>	<b>504106749</b>	Galet tendeur	1
<b>66488</b>	<b>504106751</b>	Galet tendeur	1
<b>64833</b>	<b>504153873</b>	Galet tendeur	1



RÉF ATS	RÉF ORIGINE	DÉSIGNATION	APPLICATION
<b>86021</b>	<b>503142100</b>	Kit galet tendeur courroie 2 alternateurs 140A + 140A	Magelys HD, HDH, Pro Euro 4, 5 moteur F3A
DÉTAILS DU KIT			
RÉF ATS	RÉF ORIGINE	DÉSIGNATION	QTÉ
<b>85280</b>	<b>16691224</b>	Vis tête cylindrique	1
<b>62760</b>	<b>504073027</b>	Courroie	1
<b>66611</b>	<b>504075247</b>	Tendeur courroie	1
<b>70263</b>	<b>504085883</b>	Poulie de renvoi	1
<b>64833</b>	<b>504153873</b>	Galet tendeur	1
<b>72892</b>	<b>504176626</b>	Courroie	1



RÉF ATS	RÉF ORIGINE	DÉSIGNATION	APPLICATION
<b>86163</b>	<b>503142098</b>	Kit galet tendeur courroie 2 alternateurs 90A + 90A	Recreo Euro 4, 5 moteur F4A
DÉTAILS DU KIT			
RÉF ATS	RÉF ORIGINE	DÉSIGNATION	QTÉ
<b>92178</b>	<b>16692824</b>	Vis tête cylindrique	1
<b>581300</b>	<b>500387660</b>	Courroie	1
<b>66489</b>	<b>504065877</b>	Poulie de renvoi	2
<b>67041</b>	<b>504065878</b>	Poulie de renvoi	1
<b>81151</b>	<b>504315785</b>	Galet tendeur	1



RÉF ATS	RÉF ORIGINE	DÉSIGNATION	APPLICATION
<b>92176</b>	<b>503142099</b>	Kit galet tendeur 2 alternateurs 140A + 80A	Evadys HD 12 m 80 Euro 4, 5 moteur F3A
DÉTAILS DU KIT			
RÉF ATS	RÉF ORIGINE	DÉSIGNATION	QTÉ
<b>92179</b>	<b>16673635</b>	Vis	3
<b>85280</b>	<b>16691224</b>	Vis tête cylindrique	1
<b>62760</b>	<b>504073027</b>	Courroie	1
<b>66611</b>	<b>504075247</b>	Tendeur courroie	1
<b>70263</b>	<b>504085883</b>	Poulie de renvoi	1
<b>67557</b>	<b>504090403</b>	Courroie	1
<b>70262</b>	<b>504112880</b>	Poulie de renvoi	1
<b>64833</b>	<b>504153873</b>	Galet tendeur	1



## Man



RÉF ATS	DÉSIGNATION	APPLICATION
<b>69522</b>	Galet de guidage Ø int 20 - Ø ext 74 - Ep 42	Fast Scoler 3, Fast Jumbo, Man Lion's Star, Coach, NU, UL Moteur Man D0836LOH, D20
RÉF ATS	DÉSIGNATION	APPLICATION
<b>60025</b>	Galet tendeur	Fast Scoler 3, Fast Jumbo Moteur Man D0836LOH, D2866
RÉF ATS	DÉSIGNATION	APPLICATION
<b>68617</b>	Galet tendeur	Vanhool T9 Euro 4, 5 - Moteur Man D2066, LOH01-08, 10-12, D2066LUH01-05/07-09, 11-18, 21-24, 26-28, 41-43, 47, 48
<b>62985</b>	Galet tendeur Moteur sans air conditionné	Moteur D2866LF20-25/29-31/34/35/39/40 D2866LF24 OEBH D2866LF26-28/32/36/37/41/43 D2876LF01-03/06/08-10/14/17 D2876LF12/13
<b>62986</b>	Galet tendeur Moteur avec air conditionné	
<b>78884</b>	Galet seul	





### Man

RÉF ATS	DÉSIGNATION	APPLICATION	
<b>68616</b>	Tendeur de courroie Ø 74 - H 1 34 - H2 90	Fast Scoler 3 châssis A91 avec alternateur 2x110A - Moteur D2866LUH, D2066LUH, D0836LOH40/41/50, D0836LUH40/41/50, D2066LUH01UH01-05/07-09/11 - 8/21 24/26-28/41-43/47/48, D2866LUH23/24/25/27-30/34-37/50-52	
<b>65542</b>	Poulie d'inversion Ø 74,15 - H3 3,9	Man Lion's R07, R08, Vanhool T9 - Moteur D0836LH40/41/50, D2066LOH Man Euro 4, 5	
<b>65476</b>	Galet tendeur Ø 74 - H 28,3	Vanhool T9 Euro 3, 4 Temsas Safari, Neoplan Moteur D2866LOH27-29/32/33/34/35/37/38 D2876LOH02/03/04/05 D2066LOH01-08/10-12	
<b>66856</b>	Galet 2 gorges avec support alternateur	Moteur D0836LOH01/02/03/04 D0834LOH01/02/03	
<b>69960</b>	Galet Climatisation	Temsas MD9 Safari, Tourliner P21, 22, Lion's R07, R08, Vanhool T9, Fast Syter Moteur D0836LOH 40/41/50, D28 66LOH27-29/32/33/34/35/37/38, D2866LUH23/24/27-30/34-37/50-52	

### Renault

RÉF ATS	DÉSIGNATION	APPLICATION	
<b>75932</b>	Poulie Ø 70 - H 1 38 - H2 100	Fast Scoler 4 Moteur Renault DXI7	
<b>75941</b>	Galet Ø 78 - I 57	Fast Scoler 4 Moteur Renault DXI7	

### Scania

RÉF ATS	DÉSIGNATION	APPLICATION	
<b>64835</b>	Galet Ø ext 95 - Ø int 10 - I 32	Série 4, K124 Irizar Century Moteur DSC11, DSC12, DSC14	
<b>64836</b>	Tendeur Ø 74 - I 38	Série 4, L94, K94, K124 Omnicity	
<b>67422</b>	Tendeur Ø 74 - H1 32 - H2 67,5	Série 4, L94, K94	

## Scania

RÉF ATS	DÉSIGNATION	APPLICATION	
<b>77133</b>	Galet Ø 74 - H1 38,3 - H2 40,1 74 X 36	K94, K114 Moteur DC9, 19, 20, 21	
<b>74571</b>	Poulie Ø 74 - H1 32 - H2 37,1	Série 4 Moteur DC9, DSC9, DC12	
<b>74697</b>	Poulie Pompe à eau	Série 4 K/L/N94, K114, K124	
<b>74572</b>	Poulie de renvoi Ø 100 - H1 33 - H2 100	Série 4 Moteur DC11.01, DC11.02, DC11.03, DT12.08	
<b>77134</b>	Poulie tendeur 2 gorges Ø int 10,9 - Ø ext 90 - H 52	Série 4	
<b>77131</b>	Poulie alternateur 2 gorges Ø int 7 - Ø ext 76	Série 3, 4	
<b>89571</b>	Galet Ø 74,21 - H1 39,01 - H2 40,46	Série 4, série F/K/N Moteur DC9 XPI, DC13	
<b>95257</b>	Galet tendeur Ø 74 - H1 39,01 - H2 46,4	Série 4, série F/K/N Moteur DC9 XPI, DC13, DC9	
<b>92156</b>	Poulie	Série 4 F114/K124, série F/K/N,	
<b>74570</b>	Galet Ø 80 H1 34 - H2 37,6	Série 4, série K/N/F Moteur DC9	
<b>92158</b>	Poulie	Série 4, K/L/N94 Moteur DC9	
<b>91826</b>	Tendeur Ø 74 - I 32	Série 4, K/L/N Moteur DC9 XPI, OC9, DC13	

### Volvo

<b>RÉF ATS</b>	DÉSIGNATION	APPLICATION	
<b>53466</b>	Tendeur Ø ext 76,2 - l 35,5	B12 Moteur D10A, D12A	
<b>RÉF ATS</b>	DÉSIGNATION	APPLICATION	
<b>53484</b>	Galet - Acier 70 X 35,5	B7L, B10M, B10B, B12 Moteur D7C, D10A, D12A	
<b>72978</b>	Galet - Acier Ø 74	B10L, B10 Moteur D10A	
<b>RÉF ATS</b>	DÉSIGNATION	APPLICATION	
<b>66591</b>	Tendeur compresseur d'air et alternateur Ø 74 - l 38,5	B10L, B12M, B9S / TL 9700, 9900, 7700	
<b>RÉF ATS</b>	DÉSIGNATION	APPLICATION	
<b>91158</b>	Tendeur de courroie Ø 79 - l 39	Moteur D10A	
<b>RÉF ATS</b>	DÉSIGNATION	APPLICATION	
<b>76774</b>	Tendeur Poulie métallique Ø 74 - H1 38,3 - H2 58,5	8700, 9700 B9L/ B/S/TL B12M/B	
<b>RÉF ATS</b>	DÉSIGNATION	APPLICATION	
<b>67424</b>	Tendeur de courroie	B7L, B9L, B9R, B9S, B9TL, B10L, B11R, B12B, B12M Moteur D9A, D12C-D, D13A	
<b>RÉF ATS</b>	DÉSIGNATION	APPLICATION	
<b>73912</b>	Poulie tendeur alternateur 2 gorges	B10L, GX217, 417	
<b>RÉF ATS</b>	DÉSIGNATION	APPLICATION	
<b>73916</b>	Poulie alternateur Ø int 25 - Ø ext 70 - l 42,6	B12B/M, B7L, B9S	
<b>RÉF ATS</b>	DÉSIGNATION	APPLICATION	
<b>77861</b>	Tendeur de courroie Ø 74 - H1 33,3 - H2 76,5	B9L/R/S/TL 7700	
<b>RÉF ATS</b>	DÉSIGNATION	APPLICATION	
<b>92159</b>	Tendeur de courroie	B12 dep châssis 7054	

## Cummins

RÉF ATS	DÉSIGNATION	APPLICATION	
<b>70386</b>	Pompe à eau livrée sans joint Moteur Cummins ISBE6, ISBE4	BMC Probus Otokar Navigo	
<b>65872</b>	Joint	Temsa Tourmalin	

## DAF

RÉF ATS	DÉSIGNATION	APPLICATION	
<b>35846</b>	Pompe à eau Moteur DAF DKTD 1160, DKST 1160, DKSE 1160, DKS 1160	Bova FHD 12-360	

RÉF ATS	DÉSIGNATION	APPLICATION	
<b>66505</b>	Pompe à eau Moteur DAF WS242, WS268, WS295	Bova FDH12-340, FLD12-300 Euro 1, 2	

RÉF ATS	DÉSIGNATION	APPLICATION	
<b>66917</b>	Pompe à eau Moteur DAF XE250, XE315	Bova Futura FHD Euro 3 Vanhool T9	
<b>74809</b>	Joint X 1		
<b>74810</b>	Joint X 1		

RÉF ATS	DÉSIGNATION	APPLICATION	
<b>73083</b>	Pompe à eau Moteur DAF MX	Bova Futura FHD 104, 120, 127 Euro 4, 5, Vanhool T9, Temsa	

RÉF ATS	DÉSIGNATION	APPLICATION	
<b>76030</b>	Pompe à eau Moteur DAF PR	Bova FHD, FLD, Temsa Euro 3	

## Fast

RÉF ATS	DÉSIGNATION	APPLICATION	
<b>76032</b>	Pompe à eau Moteur Man D0836 LOH 51-58/62/63	Fast Scoler 3, Starter châssis Man A91 Euro 4	

RÉF ATS	DÉSIGNATION	APPLICATION	
<b>76031</b>	Pompe à eau Moteur Man D2066 LUH 01-05/07/09/11-18/21-24/26- 28/41-43/47/48	Fast Scoler 3, Starter châssis Man A91 Euro 4	

RÉF ATS	DÉSIGNATION	APPLICATION	
<b>89623</b>	Pompe à eau Moteur Man D2866 LOH 27-29/32/33/34/35/37/38	Fast Syter châssis Man A51	



### Renault

RÉF ATS	DÉSIGNATION	APPLICATION	
<b>72911</b>	Pompe à eau Moteur Renault MIDR 060226W	Fast Scoler 1, 2 Euro 1, 2 Heuliez GX117	
<b>66503</b>	Pompe à eau Moteur Renault MIDR 0622045	Irisbus FR1, R312, PR100-2, PR180-2, GX107, GX187	
<b>3587</b>	Pompe à eau Moteur Renault MIDR 0622045	Irisbus PR112, PR118 dep 1987	
<b>66506</b>	Pompe à eau Moteur Renault MIDR 0622045 R41, R42, A41	Irisbus Iliade, Ares, GX 317, Agora Euro 2	
<b>66502</b>	Pompe à eau Moteur Renault DCI 11	Irisbus Iliade, Ares DCI Euro 3	
<b>75807</b>	Pompe à eau Moteur Renault M9T970, M9T672, M9T676, M9T680	Renault Master 4 dep 02/11 2,3 DCI	



### Iveco

RÉF ATS	DÉSIGNATION	APPLICATION	
<b>90885</b>	Pompe à eau Moteur Iveco F1CE3481LC, F1CE0481HC, F1CE0481HA, F1CE0481B, F1CE0481A, F1CE0481FA	Iveco Daily 3, 4 136CV, 140CV, 146CV, 166CV, 170CV, 176CV	
<b>90886</b>	Entretoise	À commander obligatoirement	
<b>44872</b>	Pompe à eau Moteur Iveco 8460.41E, R, S, T, M	Irisbus Iveco Eurorider, Euroclass	
<b>54641</b>	Pompe à eau Moteur Iveco 8060.41S, R, M, T, E, L, N		
<b>44871</b>	Pompe à eau Moteur Iveco 8060.45S, M	Irisbus Iveco Scolabus, Mago 1	

## Iveco

RÉF ATS	DÉSIGNATION	APPLICATION	
<b>73233</b>	Pompe à eau poulie <b>10 gorges</b> Moteur Iveco F2BE Cursor 8 (livrée sans joint)	Irisbus Recreo, Axer, Ares, Arway, Agora Line, Evadys Euro 3, 4, GX317, GX327	
<b>55366</b>	Joint		
RÉF ATS	DÉSIGNATION	APPLICATION	
<b>64874</b>	Pompe à eau Moteur Iveco F3AE cursor 10	Irisbus Evadys HD, Arway 15m, Magelys HD, HDH, Domino HD, HDH Euro 4, 5, Magelys Pro	
RÉF ATS	DÉSIGNATION	APPLICATION	
<b>70386</b>	Pompe à eau livrée sans joint Moteur Iveco Tector F4AE Tector 7	GX137, 327 Hybrid, 337, 437 Irisbus Recreo New, Crossway, GX117, GX127, Midys, Midirider, Mago 2, Proxys, CC100, CC130, CC150, Urbanway	
<b>65872</b>	Joint		
RÉF ATS	DÉSIGNATION	APPLICATION	
<b>73497</b>	Pompe à eau poulie <b>4 gorges</b> Moteur Iveco Cursor F2BE	Irisbus Recreo, Crossway, Arway	
RÉF ATS	DÉSIGNATION	APPLICATION	
<b>93456</b>	Pompe à eau Cursor 9	Crossway Euro 6, Crossway LE Euro 6 Magelys Euro 6, Urbanway Euro 6	
<b>55366</b>	Joint	GX437, Arway Euro 6	

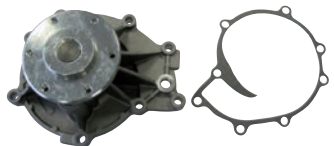
## Man

RÉF ATS	DÉSIGNATION	APPLICATION	
<b>76973</b>	Pompe à eau Moteur Man D0836LOH40/41/50	Fast, Man, Neoplan, Vanhool	
RÉF ATS	DÉSIGNATION	APPLICATION	
<b>76031</b>	Pompe à eau Moteur Man D2866LUH 23/24/25/27-30/34-37/50-52 - D2066LUH 01-05/07-09/11-18/21- 24/26/28/41-43/47/48 Euro 4	Man Lion's City A21, A22, Man Lion's Regio R12, R13, R14 Neoplan Trendliner P23/24 Vanhool T9 CL	
RÉF ATS	DÉSIGNATION	APPLICATION	
<b>89623</b>	Pompe à eau Moteur Man D2876LOH 01/02/03/04/05 - D2866LOH 27-29/32/33/34/35/37/38 - F2866LUH 23/24/25/27-30/34- 37/50-52 - D2866LOH 20-26/30/31 - D2866LUH 20/21/22/26 Euro 3 avec EDC et ralentisseur hydraulique Turbine Ø 135	Man Trendliner P23, 24 Tourliner P21, 22 Man Sue 313 châssis A72 Man Lion's Regio R12, 13, 14 Temsä Safari, Tourmalin Vanhool T9 CL, TL, Acron, Alicron, Altano, A320	

### Man

RÉF ATS	DÉSIGNATION	APPLICATION	
<b>89622</b>	Pompe à eau Moteur Man D2066LOH 01-08/10-12 D2676LOH 01-04/10 Euro 4	Man Lion's Coach R07, R08 Neoplan Cityliner P14, 15, 16 Tourliner P21, 22 Temsa Safari HD, RD Vanhool T9 Acron, Alicron, Altano	
<b>66509</b>	Pompe à eau Moteur Man D2866LUH 20/21/22/26 D2866LOH 20-26/30/31 - D2876LOH 02/03/04 Euro 2, 3 sans ralentisseur hydraulique et EDC Turbine Ø 125	Neoplan N122, N116 Vanhool T9 TL, Acron, Alicron, Altano	
<b>66507</b>	Pompe à eau Moteur Man D2866LOH 20-26/30/31 - D2866LUH 01-02 D2866LOH, TOH, LXOH sans ralentisseur hydraulique sans EDC. Turbine Ø 135	Neoplan N116, N122 Vanhool T8	
<b>76032</b>	Pompe à eau Moteur Man D0834LOH 50/51/52/53 - D0836LOH 51-58/62/63 - 8 ailettes L 224 mm - l 185 mm - Ep 126 mm	Man Lion's City A21, A22 Vanhool Urbain	
<b>65849</b>	Pompe à eau Moteur Man D0834LOH 01/02/03/04 - D0836LOH 01/02/03/04 Poulie Ø 107 mm - Euro 2, 3	Man châssis A53 Vanhool Urbain A308 new, A330	
<b>90887</b>	Pompe à eau Moteur Man D0836LOH65 Filetage M16 X 1,5 L 225 mm X l 180,3 mm X Ep 127, 2 mm 8 ailettes	Otokar Vectio	
<b>92009</b>	Pompe à eau Moteur Man D0836LOH01/02/03, D0836LOH40/51/52/55/56, D0836LOH60/61/62 Filetage M16 X 1,5 Filetage M18 X 1,5 8 ailettes	Otokar Vectio	

## Man

RÉF ATS	DÉSIGNATION	APPLICATION	
<b>72913</b>	Pompe à eau Moteur Man D0826LOH 15/17/18/19	Vanhool A308L	
<b>36051</b>	Pompe à eau Moteur Man D0826LOH 01-13 D0824LOH 01/02/03/04/05 D0826LOH 15/17/18/19	Man A76 12-220 HOCL/R-NL Man 469 10/11-50/180/190/220/230 Man A72 Lion's Classic UE Man A66 12/14-220 HOCL/R-NF Vanhool A308	
<b>72914</b>	Pompe à eau Moteur Man D0826LUH 01-06/08/10/12/13 D0826LUH 12 H 90 mm	Man A20	
<b>72915</b>	Pompe à eau Moteur Man D0826LUH 01-06/08/10/12/13 H 79,5 mm	Man A10 Man A20	







## Mercedes, Evobus

RÉF ATS	DÉSIGNATION	APPLICATION	
<b>4794</b>	Pompe à eau Moteur Mercedes OM602LA 5 cylindres	Evobus Sprinter 210, 212, 310, 312, 410, 412	
<b>61901</b>	Pompe à eau Moteur Mercedes OM611LA, OM612LA	Evobus Sprinter CDI 208, 211, 213, 216 CDI - 308, 311, 313, 316 CDI - 408, 411, 413, 416 CDI	
<b>75169</b>	Pompe à eau Moteur Mercedes OM642 jsq moteur 40777759	Evobus Sprinter V6 318, 319 CDI - 518, 519 CDI dep 06/06	
<b>69417</b>	Pompe à eau Moteur Mercedes OM642 Dep moteur 40582550 Livrée avec joint	Evobus Sprinter V6 318, 319 CDI - 518, 519 CDI dep 06/06	
<b>66957</b>	Pompe à eau Moteur Mercedes OM646 DELA Livrée avec joint	Evobus Sprinter 209, 211, 215 - 309, 311, 315 509, 511, 515 dep 06/06 jsq 03/09	

### Mercedes, Evobus

RÉF ATS	DÉSIGNATION	APPLICATION	
<b>91502</b>	Pompe à eau Moteur OM651	Evobus Sprinter, Transfer 310, 313, 316 CDI 510, 513, 516 CDI dep 03/09	
<b>76971</b>	Pompe à eau Moteur Mercedes OM906HLA, OM906.930, OM906.960	0530 Citaro Euro 3	
<b>60569</b>	Pompe à eau Moteur Mercedes OM904LA, OM906LA	Evobus 0510 Tourino 0560 Intouro 0814-0815 Varío 0530 Citaro Euro 2	
<b>71998</b>	Pompe à eau Moteur Mercedes OM926LA	Evobus 0560 Intouro Euro 4, 5	
<b>66513</b>	Pompe à eau Moteur Mercedes OM457LA, HLA avec ralentisseur Telma	Evobus Setra S315 UL, H, NF, GT, GTHD S411- 415-417HD, HDH Euro 3, 412-417UL, 415- 416NF, 415-417GTHD Mercedes 0580, 0350, 0550 Euro 3, 0530 Citaro Euro 3, 4	
<b>66514</b>	Pompe à eau Moteur Mercedes OM457LA, HLA avec ralentisseur Voith		
<b>94829</b>	Pompe à eau Moteur Mercedes OM936LA	Citaro, Intouro, Multiclass 400, Comfort class 500 Euro 6	
<b>94825</b>	Pompe à eau Moteur Mercedes OM470LA, OM471LA	New Tourismo, Comfort class 500, Top Class 500 Euro 6	
<b>66508</b>	Pompe à eau Moteur Mercedes OM401A, OM402A, OM403, OM404A, OM407A, AH, H, HA, LA - OM421A, LA - OM422A, LA - OM423A, LA - OM424A, LA - OM427A, H, HA, LA - OM441A, LA - OM442A, LA - OM443, OM444, OM447A, H, HA, LA Turbine Ø 125 sans ralentisseur Voith	Evobus Setra série 200, 300 Mercedes 0303, 0405, 0408 Bova FHM 12-380, FLM 12-290	

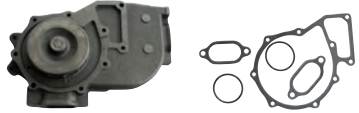
## Mercedes, Evobus

RÉF ATS	DÉSIGNATION	APPLICATION	
<b>67383</b>	Pompe à eau Moteur Mercedes OM401.901/917 moteur dep 129661, OM402.907/918, OM421.908, OM422.908/951, OM407AH951 moteur dep 017498- OM427HA/950, OM447H, HA, HLA - OM427H, OM447H Turbine Ø 125 avec ralentisseur Voith	Evobus Setra série 200, 300 Mercedes 0345, 0303, 0405	
<b>67385</b>	Pompe à eau Moteur Mercedes OM422 jsq moteur 146024. Turbine Ø 135 avec ralentisseur Voith	Evobus Setra série 200 Mercedes 0303	
<b>67384</b>	Pompe à eau Moteur Mercedes OM402LA, OM442LA	Evobus Setra 315HD, HDH 316 HDS	
<b>65117</b>	Pompe à eau Moteur OM501 LA sans retarder	Evobus Setra 411HD Neoplan Euroliner	
<b>62755</b>	Pompe à eau Moteur Mercedes OM502LA	Evobus Setra 415-417HD, HDH, GTHD, 431DT Mercedes Travego	
<b>71997</b>	Pompe à eau Moteur Mercedes OM501LA, OM502LA avec Voith	Evobus Setra 415-417HD, HDH, GTHD, 431DT Mercedes Travego	

## Scania

RÉF ATS	DÉSIGNATION	APPLICATION	
<b>42621</b>	Pompe à eau Moteur Scania DSC11	Scania série 2, 3 K112, K113, K93	
<b>69310</b>	Pompe à eau Moteur Scania DSC1174/75/76 DC9 19/20/21 D11/12 jsq 6241333SSS jsq 8044161 SLA	Scania série 4 K114, K124	
<b>74615</b>	Pompe à eau Moteur Scania DT12.13, DC11.02, DC12.13, DC13.05, DC9.12/13/16/17 dep 6241334, dep 8044162SLA	Scania série 4 K114/K124/K94	

### Scania

RÉF ATS	DÉSIGNATION	APPLICATION	
<b>75181</b>	Pompe à eau Moteur Scania D9	Scania Omnicity K94/L94	

### Volvo

RÉF ATS	DÉSIGNATION	APPLICATION	
<b>72970</b>	Pompe à eau Moteur Volvo D9A, D9B Euro 4 Poulie Ø 168	Volvo B9L, R, S, TL	

RÉF ATS	DÉSIGNATION	APPLICATION	
<b>66512</b>	Pompe à eau Moteur Volvo D12C 27 dents Ø 85 Livrée avec joint	Volvo B12, B12R	

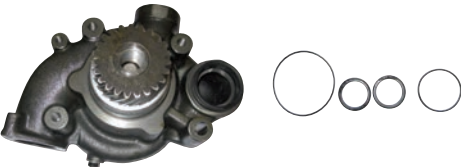
RÉF ATS	DÉSIGNATION	APPLICATION	
<b>66510</b>	Pompe à eau Moteur Volvo D6, D7A, D7B	Volvo 7700, B6BLE, B7L, B7LDD, B7R	

RÉF ATS	DÉSIGNATION	APPLICATION	
<b>63316</b>	Pompe à eau Moteur Volvo TD101/102/103 TD121/122/123	Volvo B12	

RÉF ATS	DÉSIGNATION	APPLICATION	
<b>72966</b>	Pompe à eau Moteur Volvo DH10A	Volvo B10L, GX217, 417	

### Volkswagen

RÉF ATS	DÉSIGNATION	APPLICATION	
<b>69246</b>	Pompe à eau Moteur Volkswagen BJJ, BJM, BJL, BJK	Volkswagen Crafter 2,5 TDI jsq 07/2011	

RÉF ATS	DÉSIGNATION	APPLICATION	
<b>90762</b>	Pompe à eau Moteur Volkswagen CKTC, CKUB, CKUC Moteur 2,0 TDI 136 CV, 142 CV, 163 CV	Volkswagen Crafter dep 07/11	



## Cummins

RÉF ATS	DÉSIGNATION	T°	MOTEUR	
<b>81532</b>	Thermostat BMC Alyos, Probus Euro 4, 5		Moteur ISBE 4.5	
<b>81533</b>	Joint		225 CV, 250 CV	

## DAF

RÉF ATS	DÉSIGNATION	T°	MOTEUR	
<b>54652</b>	Thermostat Bova, Temsa, Vanhool	82	Moteur DAF PR 265C, S, XFM280M, XF315M, XE250C, MX300, PF183M	



## Evobus

RÉF ATS	DÉSIGNATION	T°	MOTEUR	
<b>38509</b>	Thermostat Evobus, Neoplan, Temsa, Vanhool	71	Moteur OM401, 402, 422, 441	
<b>38508</b>		79	Moteur OM442, 447	
<b>38507</b>		83	Moteur OM	
<b>94830</b>	Citaro, Intouro, Multiclass 500, Comfort class 500		Moteur OM936LA Euro 6	
<b>94826</b>	Travego, Multiclass 400, Comfort class 500, Top class 500		Moteur OM470LA, OM471LA Euro 6	

## Irisbus, Renault

RÉF ATS	DÉSIGNATION	T°	MOTEUR	
<b>50945</b>	Thermostat Irisbus Agora, Ares, FR1, Iliade, R312, PR100-2, PR112	83	Moteur MIDR 0622045 Euro 0, 1, 2	
<b>54652</b>	Thermostat Irisbus Ares, Iliade	82	Moteur Irisbus DCI Euro 3	

## Iveco

RÉF ATS	DÉSIGNATION	T°	MOTEUR	
<b>50941</b>	Thermostat Irisbus Tracer, Recreo	83	Moteur Renault MIDR 0622045 Euro 1, 2	
<b>54132</b>	Thermostat Irisbus Evadys, Ares, Axer, Recreo, Arway	83	Moteur Iveco F2BE Cursor 8 Euro 3, 4	
<b>79207</b>	Joint			
<b>85821</b>	Thermostat Irisbus Recreo, Crossway, Midirider, Midys, GX127	79	Moteur Iveco F4AE Tector, Euro 3, 4, 5 Tector 7 Euro 6	
<b>82029</b>	Thermostat Irisbus Magelys, Arway 15m, Evadys	79	Moteur Iveco F4AE Tector 10, 13	

### Man

RÉF ATS	DÉSIGNATION	T°	MOTEUR	
<b>38509</b>	Thermostat Evobus, Neoplan, Temsa, Vanhool	71	Moteur D2566, 2866, 2876	
<b>38508</b>		79	Moteur D2566, 2866, 2876	
<b>38507</b>		83	Moteur D2566, 2866, 2876, 2066, D0836LOH Euro 4, 5	

### Scania

RÉF ATS	DÉSIGNATION	T°	MOTEUR	
<b>62454</b>	Thermostat Scania K113 CLB	70	Moteur DC, DSC 11	
<b>35127</b>	Thermostat Scania K113 CLP, TLB, K113 CLA, CRA	79		

RÉF ATS	DÉSIGNATION	T°	MOTEUR	
<b>75184</b>	Thermostat Scania K114, K124, F, K, L, N94	80 + 87	Moteur DSC 11, 12 BVGR/GRS 90R	
<b>91137</b>		75 + 80		









### Volkswagen

RÉF ATS	DÉSIGNATION	T°	MOTEUR	
<b>69243</b>	Thermostat Volkswagen Crafter	87	Moteur BJM, BJK, BJJ	

### Volvo



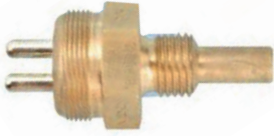





RÉF ATS	DÉSIGNATION	T°	MOTEUR	
<b>35124</b>	Thermostat Volvo B6, B7L, R, B9L, R, S, TL, B10B, BLE, L, M, B12B, M, B13R	60	Moteur D6A, DC7 THD 101G, 102K, 103K, DH10A THD 101K, K, THD 122 FL, FH, D12A, B	
<b>62450</b>	Thermostat Volvo B6, B7, B12	86	Moteur D6A, D7A, D12A, D12B	
<b>54654</b>	Thermostat Volvo B7C, B7R, B10B, B10M, B10L, B12	71	Moteur D7A, B, C THD 101, 102, 103, 104 D10A, DH10A TD 122 FL, FH TD102	
<b>54652</b>		82		
<b>82032</b>	Thermostat Volvo 9500, 9700, 9900 B9R, L, S, TL, B11R, B12B, M, B13R	82	Moteur DH12E, DH12D, D13C	

## > ENVIRONNEMENT MOTEUR



RÉF ATS	DÉSIGNATION	APPLICATION	
<b>42506</b>	Sonde de température Moteur Man 100°	Moteur D0824, LF01-07, LOH 01-03 moteur D0826 LOH01-08, 15 LUH01-06, 08, 10 moteur D2876LF02, D2866 LUH, LOH 01, 04, 06	
<b>42504</b>	Sonde de température Moteur Man 100°	Moteur D2566MTUH, MUH, moteur D2866LUH	
<b>42515</b>	Sonde de température Moteur Man 95°	Moteur D2566MKH, MUH, MTUH moteur D2866LUH, TUH, KOH, UH, LOH, LXOH, TOH	
<b>65671</b>	Sonde de température M16 X 1,5	Moteur D0826LUH, 01-06/08/10/12/13 Moteur D2866 LOH20-26/30/31 Moteur D2866 LUH23/24/25/27-30/34- 37/50-52 Moteur D2876LF01-05/07/11/20/21/22/24	
<b>31412</b>	Sonde de température Mercedes 105°, 120° M14 X 1,5 - 2 pôles	Moteur OM401, 402, 403, 421, 422, A - OM441A, LA -OM442A, OM447HLA	
<b>84517</b>	Sonde de température huile, gasoil, eau M14 X 1,5/120° maxi	Moteur OM457LA/HLA, OM460LA, OM470/417LA, OM501/502LA, OM904LA, OM906LA/HLA, OM926LA	
<b>84519</b>	Sonde de température huile, gasoil, eau M14 X 1,5/130° maxi	Moteur OM457LA/HLA, OM501/502LA, OM904LA	
<b>81758</b>	Sonde de température	Moteur OM457LA, OM502LA, OM904LA, OM906LA/HLA, OM926LA	
<b>61920</b>	Capteur de température d'eau Moteur Euro 3 Renault DCI	Iliade, Ares, Scoler 2	
<b>55446</b>	Sonde de température moteur F2B Cursor	GX127, GX317, Agora, Ares, Axer, Citelis, Cityclass, Evadys, Recreo C955	

<b>RÉF ATS</b>	DÉSIGNATION	APPLICATION	
<b>66330</b>	Sonde de température d'eau Moteur Tector F4AE	Recreo, Crossway, Midirider, Midys, Mago 2, Vehixel, Euroschool, GX127 Euro 4	
<b>RÉF ATS</b>	DÉSIGNATION	APPLICATION	
<b>43912</b>	Sonde de température ventilateur linnig M 22 X 1,5	Vanhool T9	
<b>RÉF ATS</b>	DÉSIGNATION	APPLICATION	
<b>42460</b>	Sonde de température	Vanhool T8, T9	
<b>RÉF ATS</b>	DÉSIGNATION	APPLICATION	
<b>91624</b>	Capteur de température	Vanhool T9 Euro 4 Moteur D20	
<b>RÉF ATS</b>	DÉSIGNATION	APPLICATION	
<b>92164</b>	Sonde de température d'eau M14 X 1,5 120°	Scania série 4 DC9, DC11, DC12	
<b>RÉF ATS</b>	DÉSIGNATION	APPLICATION	
<b>69907</b>	Sonde de température d'eau M12 X 1,5	Volvo B9L, R, S, TL / B13 Volvo 9500, 9700	
<b>RÉF ATS</b>	DÉSIGNATION	APPLICATION	
<b>92710</b>	Sonde de température	Volvo B9R, S, TL	
<b>RÉF ATS</b>	DÉSIGNATION	APPLICATION	
<b>92711</b>	Capteur de température	Volvo B12B, M, R	
<b>RÉF ATS</b>	DÉSIGNATION	APPLICATION	
<b>92712</b>	Capteur de température ventilateur	Volvo B9R, B, M	



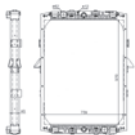

## > ENVIRONNEMENT MOTEUR

RÉF ATS	DÉSIGNATION	APPLICATION	
<b>71101</b>	Transmetteur niveau d'eau sur vase d'expansion	Heuliez GX317 Irisbus Agora, Citelis, Ares (fabrication 72A) Fast Scoler 1, 2	
<b>54904</b>	Transmetteur niveau d'eau	Irisbus Recreo Euro 2 Moteur Renault MIDR 0622045	
<b>57871</b>		Irisbus Recreo, Axer Euro 3 Moteur Iveco Cursor F2BE	
<b>14348</b>	Transmetteur niveau d'eau sur vase d'expansion	Man A20, A21 Lion's City, Man A23, 24, 25, 26, 27, 28, 30, 31 - Man R07, R08, Neoplan Starliner, Tourliner, P21, P22, Centroliner, N4516, N4521, Fast Syter A51, Fast Stylus A53, Vanhool T9, TX	
<b>72903</b>	Sonde niveau refroidissement sur vase d'expansion	Bova Futura, Temsa Safari Moteur DAF XE, MX	
<b>60617</b>	Transmetteur niveau d'eau M12 X 1,5	Scania série 3, 4	
<b>74692</b>	Sonde de niveau	Scania série 4 F, K, N Moteur DC9/11, DC, DCS12	
<b>63368</b>	Sonde niveau refroidissement sur vase d'expansion	Volvo 7700, 8700, 9700	

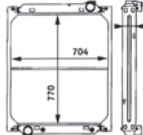

### Bova

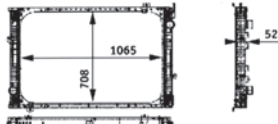
RÉF ATS	DÉSIGNATION	PARTICULARITÉS	
<b>70115</b>	Bova FLD 12-300	Moteur RS222M Euro 1, 2 969 X 754 X 40	
<b>68700</b>	Bova FLD	Moteur XE280C1 Euro 3 900 X 708 X 52	
<b>70179</b>	Bova Futura, Magiq, FHD 104, 120, 127 - MHD 120, 22, 131, 139	PR265S MX300 689 X 900 X 48	

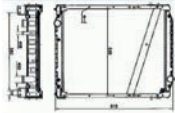
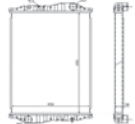
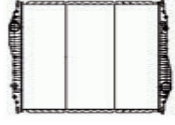
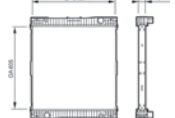
### Evobus

RÉF ATS	DÉSIGNATION	PARTICULARITÉS	
<b>60806</b>	OM441LA - OM402LA - OM442LA	Evobus 0350, 0404 Euro 2 700 X 704	
<b>60819</b>	OM501LA - OM457LA - OM502LA	411HD, 415HD, 417HDH, 416HDH, 415, 416GTHD, 0580 Travego 1015 X 808 X 42	
<b>60821</b>	OM457HLA - OM926LA - OM457LA	Setra 412-419UL - Setra 415 GT Integro New Châssis 633 1065 X 708 X 52	
<b>60823</b>	OM441LA	Setra 315 850 X 658	
<b>Plus livrable</b>	OM441LA - OM442LA	Setra 315 - 319GTHD 960 X 658	
<b>71008</b>	OM447HLA	S315-319 NF 618 X 750 X 55	
<b>64973</b>	OM442 LA, OM441 LA	Setra Topclass 315 HD 850 X 659 X 58	
<b>71009</b>	OM441LA Euro 1, 2	S315H 657,9 X 760 X 53 (sans cadre)	
<b>73783</b>	OM457HLA	0530 Citaro 616,10 X 605 X 52	

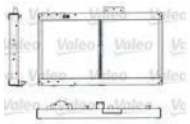
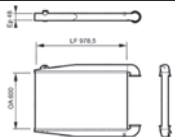
## Evobus

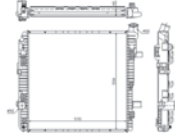
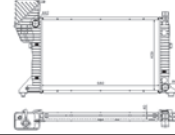
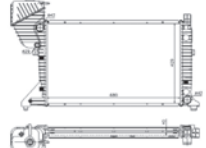
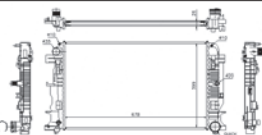
RÉF ATS	DÉSIGNATION	PARTICULARITÉS	
<b>64970</b>	OM 906	Evobus Citaro 0530 Euro 2 785 X 655 X 95	
<b>72530</b>	OM457 HLA	Evobus Citaro Euro 3 L1216 H605 Ep 52	
<b>62924</b>	OM457 HLA	Citaro Euro 3 L 600 X H 978,5 X P 65 mm	
<b>64972</b>	OM457 HLA	Evobus 0530 Euro 3, 315NF Euro 3 1015 X 810 X 48	
<b>64971</b>	OM447 HLA D2866LUH	Evobus 0550 integro S315UL Euro 2	
<b>64975</b>	OM904 LA	Mercedes Vario 0812, 814, 815 boîte mécanique - Dep 07/96 570 X 559 X 40	
<b>64977</b>	OM602 980	Mercedes 312D, 412D 680 X 409 X 40	
<b>64976</b>	OM612-981	Mercedes Sprinter 413 CDI, 416 CDI, 313 CDI, 316 CDI Boîte mécanique Dep 04/2000 à 2007 680 X 409 X 40	
<b>66529</b>	OM646 986 (4 CYLINDRES) OM642 992 (V6) Moteur BJJ	Sprinter dep 06/06 avec boîte de vitesse manuelle Crafter 2,5 TDI dep 04/06 678 X 399 X 26	

## Fast

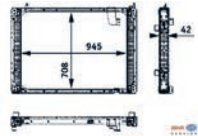
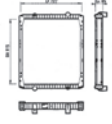
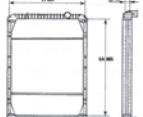
RÉF ATS	DÉSIGNATION	PARTICULARITÉS	
<b>65710</b>	MAN D2866 LOH Euro 3	Fast Syter châssis A 51 945 X 708 X 42	
<b>65966</b>	MIDR 060226W Euro 2	Fast Scoler 2 915 X 727 X 85	
<b>72933</b>	Moteur 062226W Euro 2	Fast Scoler 2 870 X 688 X 52	



### Fast

RÉF ATS	DÉSIGNATION	PARTICULARITÉS	
<b>75939</b>	DXI7	Fast Scoler 4 710 X 568 X 52	



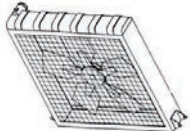
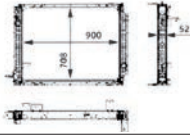
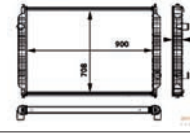
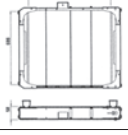

### Iveco/Irisbus

RÉF ATS	DÉSIGNATION	PARTICULARITÉS	
<b>78729</b>	F1CE 0481HA 2998 cm3	Daily 3 dep 05/06, 140CV, 170CV, 176CV 650 X 456 X 32	
<b>65970</b>	F1AE0481A, F1AE0481B	Daily 2 dep 09/02 650 X 440 X 36	
<b>69429</b>	F1AE 0481A	Daily 2 dep 09/02 625 X 460 X 36	
<b>69430</b>	8140.43N, 8140.43S, 8140.43C, 8140.43C	Daily 2 Dep 11/01 jsq 04/06 649 X 440 X 27	
<b>60785</b>	Cursor F2B - Moteur Iveco	Agora, Citelis, GX327 850 X 638 X 52	
<b>60803</b>	MIDR 0622045	Agora, R312 dep 07/93, GX 317 782 X 768 X 78	
<b>60805</b>	Cursor Iveco F2B	Agora Line 630 X 537 X 46	
<b>60802</b>	MIDR 0622045	R312 892 X 691,5 X 792	
<b>78727</b>	Cursor 10 F2BE	Eurorider 38, 43, 45, Euroclass, Domino HD, HDH, Magelys HD, Pro, Arway 15mètres, Evadys HD 1035 X 790 X 70	
<b>69428</b>	Moteur Tector	GX117, GX127 810 X 708 X 52	
<b>58167</b>	MIDR 0622045, MIDR 062356	Iliade, Ares 1005 X 762 X 800	

## Iveco/Irisbus

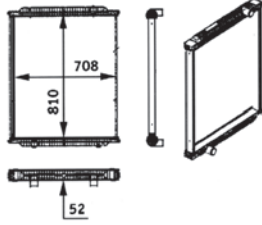
RÉF ATS	DÉSIGNATION	PARTICULARITÉS	
<b>56518</b>	Moteur Renault DCI 11 Cursor F2BE	Ares DCI 12 m - 12,8 m - 15 m Iliade DCI S, T, TE, TEC, RT, RTC, GT, GTC, CTE - Dep CAM D1, Arway Euro 4, Crossway, Recreo Dep 2007, Eurorider 33 - Euro 4 - 910 X 790 X 70	
<b>56514</b>	MIDR06622045	Moteur Renault, Recreo Euro 2	
<b>60801</b>	Cursor 8 F2BE Euro 3	Recreo, Axer, Ares jsq 2007 C955, C956 900 X 708 X 52 Avec support	
<b>70179</b>	Cursor F2BE Euro 4, 5 Tector F4AE	Crossway LE, Arway Euro 4, Recreo, Crossway 900 X 708 X 52 Sans support	
<b>56511</b>	MIDR 0622045	Tracer 686 X 775 X 58	
<b>56414</b>	MIDR 06622045	FR1 985 X 792 X 63	

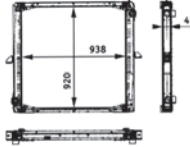
## Man, Neoman, Neoplan

RÉF ATS	DÉSIGNATION	PARTICULARITÉS	
<b>60822</b>	D0826LUH, LUH213, LUH01-06, 08, 10, 12, 13, D2865LUH02, 03, 05-09, D2866LUH20, 21, 22, 26, D0836LUH01, 02, D2866LUH23, 24, 25, 27-30, 34-37, 50-52, D0836LUH40, 41, 50, D2066LUH01-05, 07-09, 11-18, 21-24, 26-28, 41-43, 47, 48	Man A20, A21, A22, A26, A30, A34, A39, A69, A74 810 X 708 X 52	
<b>76885</b>	D0836 LUH, D0826 LUH, D2066 LUH	Man A20, A21, A22, A23, A24, A25, A26, A28, A30, A31, A34- Centroliner, Lion's city 806 X 688 X 55	
<b>60824</b>	D2866 LOH 27, 28, 29, 32, 33, 34, 35, 37, 38 D2866LOH 02, 03, 04, 05	Man Starliner, Tourliner, Lion's Coach, Lion's Star, Skyliner N122, Jetliner N214, Cityliner N116, Transliner N316, Spaceliner N117 920 X 938 X 42	
<b>76444</b>	OM441LA	Neoplan N312-316U 960 X 659 X 58	

### Man, Neoman, Neoplan

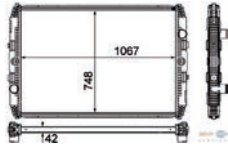
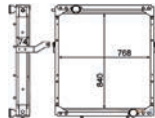
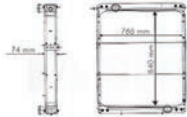
RÉF ATS	DÉSIGNATION	PARTICULARITÉS	
<b>76893</b>	D2066LUH23, 24, 25, 27-30, 34-37, 50-52, D2866LUH01-05, 07-09, 11-18, 21-24, 26-28, 41-43, 47, 47	Trendliner N3316 P23, P24, P25 R12, R13, R14 Lion's Regio 1067 X 748 X 42	
<b>78738</b>	D0836LOH51-58, 62, 63, D0836LUH40, 41, 50, D0836LOH01, 02, 03, 04	Man NM 223/283F 840 X 768 X 74	
<b>76374</b>	D0836LOH01, 02, 03, 04, D2866LUH23, 24, 25, 27-30, 34-37, 50-52	Lion's Classic, Man SUE 263, 283, 313 - A72, A74, A75/A78/A84/A85/A89/A90/A91 768 X 840 X 74	

### Renault

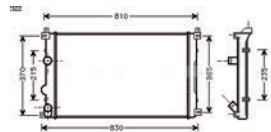
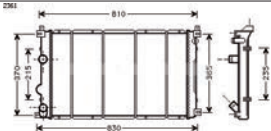
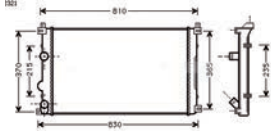
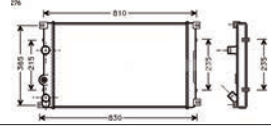
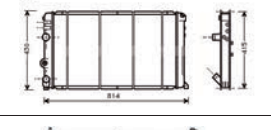
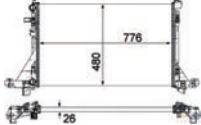
RÉF ATS	DÉSIGNATION	PARTICULARITÉS	
<b>62849</b>	Moteur F9Q, G9T, G9U, ZD3	Master dep 2003 1,9 DCI - 2,2 DCI - 2,5 DCI - 3,0 DCI 810 X 830 X 370	
<b>95560</b>	Moteur G9U, ZD3	Master dep 2003 2,5 DCI jsq 041019 - 3,0 DCI 810 X 830 X 370	
<b>62851</b>	Moteur F9Q, G9T	Master dep 2003 1,9 DCI - 2,2 DCI 810 X 370	
<b>62852</b>	Moteur F9Q, G9T, G9U, S9W	Master 1997-2003 1,9 DCI - 1,9 DTI - 2,2 DCI - 2,5 DCI - 2,8 DCI 810 X 365	
<b>62853</b>	Moteur F9Q, G9U, S9W	Master 1997-2003 1,9 DCI - 1,9 DTI - 2,5 DCI - 2,8 DTI 814 X 430	
<b>78719</b>	M9T670, M9T672, M9T676	Master dep 02/11 776 X 480 X 26	

### Scania

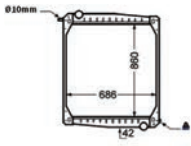
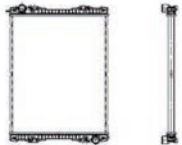
RÉF ATS	DÉSIGNATION	PARTICULARITÉS	
<b>76549</b>	Omnicity, Century	N94UD jsq châssis 1851409 SSS, K114, K124 - jsq châssis 1843282 SSS - jsq châssis 1833586 SBK - jsq châssis 3508727 SLA	
<b>78718</b>	DC9-13, DC9-16, DC9-12, DC11-09, DC12-14, DC12-15, DT12-12	K94, K114, K124 dep 09/04 689 X 860 X 40	

## Temsa

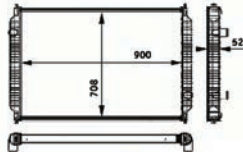
RÉF ATS	DÉSIGNATION	PARTICULARITÉS	
<b>78588</b>	Cummins ISBE6	Box Tourmalin dep 07 705 X 690 X 77	
<b>78587</b>	Man D0834FL, D0834LFL	Opalin dep 06 705 X 690 X 77	
<b>70179</b>	DAF	Safari HD, RD	

## Volkswagen

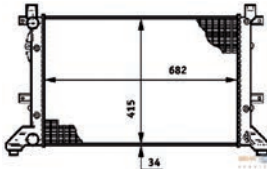
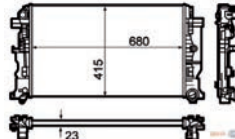
RÉF ATS	DÉSIGNATION	PARTICULARITÉS	
<b>78716</b>	2,5TDI, BBE, BBF, ANJAVR - 2,8TDI AGK, ATA, AUH, BCQ	LT 28-46 dep 05/96 jsq 07/06 682 X 415 X 34	
<b>78715</b>	BJJ, BJK 2,5 TDI	Crafter 30-50 dep 04/06 680 X 415 X 23	

## Volvo

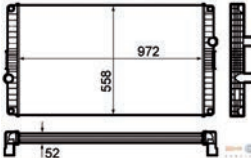
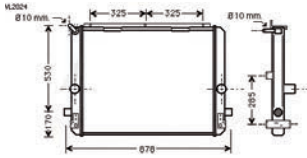
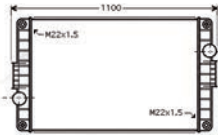
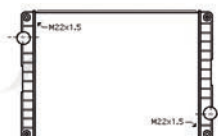
RÉF ATS	DÉSIGNATION	PARTICULARITÉS	
<b>78717</b>	THD101K, THD102K	B10L, GX217, GX417 dep 01/92 972 X 558 X 52	
<b>78669</b>	D10A	B10M dep châssis 20000 jsq 39999 700 X 675 X 60	
<b>78670</b>	D10A	B10M dep châssis 40000 B10BLE dep châssis 5271 970 X 555 X 53	
<b>78671</b>	D12A, D12B, D12D	B12M dep 08/08 876 X 807 X 52	

### Evobus série 300

RÉF ATS	DÉSIGNATION	PARTICULARITÉS	
<b>71000</b>	OM457HLA Euro 3	S315-S319 NF 645 X 1000 X 73	
<b>71001</b>	OM441LA Euro 1, 2 OM442LA	S328DT, S315H 617 X 655 X 62	
<b>71002</b>	OM447HLA Euro 1, 2 1er montage	S315-S319NF 617 X 507 X 62	
<b>71004</b>	MAN D2866LUH Euro 1, 2	S313-315UL SG321UL 612 X 606 X 62	
<b>71003</b>	OM442LA	S315GTHD 750 X 617 X 62	

### Evobus 0530 Citaro

RÉF ATS	DÉSIGNATION	PARTICULARITÉS	
<b>72961</b>	OM906	0530N3, 0530 GN3	
<b>71000</b>	OM906LA	0530G, N, NG 645 X 1000 X 73	
<b>72952</b>	OM906LA, OM457	0530 GN3, N3 750 X 523 X 80	
<b>78603</b>	OM906HLA, OM457HLA	Connecto Euro 3, Citaro Euro 3, 4, 5, Setra 415-416NF, 540 X 438 X 57	

### Evobus série 400, Travego, Integro

RÉF ATS	DÉSIGNATION	PARTICULARITÉS	
<b>61068</b>	OM457 LA, OM457HLA	Travego 0580 Confort Class, 415, GT, GTHD dep 10/03, 0550 Integro Euro 3, Setra 313 UL - 315 UL Euro 3 732 X 931 X 66	

## Evobus série 400

RÉF ATS	DÉSIGNATION	PARTICULARITÉS	
<b>61074</b>	OM457 LA	411HD, 415, 416, 417HDH, 431DT 792 X 860 X 66	

## Evobus Setra série 400, Travego

RÉF ATS	DÉSIGNATION	PARTICULARITÉS	
<b>61069</b>	OM457 LA	0580 Travego 792 X 860 X 66	

## Evobus Mercedes 0405

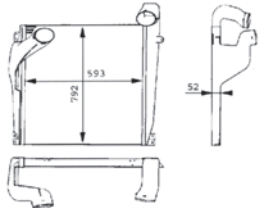
RÉF ATS	DÉSIGNATION	PARTICULARITÉS	
<b>61070</b>	OM447 HLA	04056G/GN/GTD dep 09/91 593 X 792 X 50	

## Evobus Vario

RÉF ATS	DÉSIGNATION	PARTICULARITÉS	
<b>78157</b>	OM904LA	Vario, Mediano dep 09/96 572 X 432 X 52	

## Evobus Sprinter

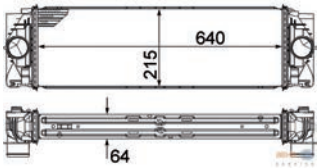
RÉF ATS	DÉSIGNATION	PARTICULARITÉS	
<b>66496</b>	OM602 980, OM611 981, OM612 981	308, 408, 410, 412 - 311, 313, 316, 411, 413, 416 CDI 04/00 - Jsq 05/06 717 X 255 X 30	
<b>78612</b>	OM642 992, OM646 990, OM651 957, OM651.955	309, 310, 311, 313, 315, 316, 318, 319 CDI 509, 510, 511, 513, 515, 516, 518, 519 CDI Dep 06/06 jsq 03/09 Dep 03/09 640 X 205 X 64	

### Fast Syter

RÉF ATS	DÉSIGNATION	PARTICULARITÉS	
<b>65711</b>	D2866 LOH Euro 3	Châssis A51 752 X 732 X 64	

### Fast Scoler 3

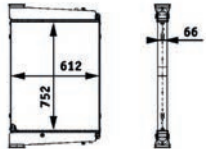
RÉF ATS	DÉSIGNATION	PARTICULARITÉS	
<b>61072</b>	D2866 LUH, D2066 LUH Euro 3, 4	Châssis A91 752 X 612 X 66	

### Fast Scoler 4

RÉF ATS	DÉSIGNATION	PARTICULARITÉS	
<b>75940</b>	DX17	Fast Scoler 4 Euro 5 720 X 532 X 50	



### Irisbus Evadys, Arway, Axer, Crossway, Recreo

RÉF ATS	DÉSIGNATION	PARTICULARITÉS	
<b>61066</b>	Cursor F2B Iveco Tector FA AE	Evadys, Arway, Axer, Ares, Recreo Crossway LE Euro 5 Crossway Euro 4, 5 812 X 593 X 64	

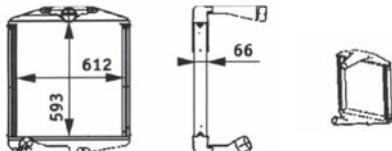
### Irisbus Agora, Citelis

RÉF ATS	DÉSIGNATION	PARTICULARITÉS	
<b>61067</b>	Cursor F2B Iveco	Agora variante 31617 593 X 612 X 66	

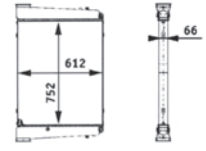
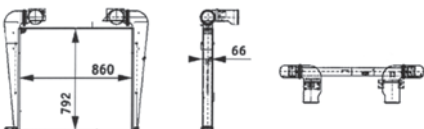
### Man, Neoplan

RÉF ATS	DÉSIGNATION	PARTICULARITÉS	
<b>61072</b>	D0836 LUH01/02 - D2866 LUH	Lion's city UE, A20, 21, 22, 23, 24, 25, 26, 30, 34, 39, 69 - Lion's classis A74, Centroliner 752 X 612 X 66	
<b>61074</b>	D2866 LOH, 28, 29, 32, 33, 34, 35, 36, 37, 38 D2876 LOH 02, 03, 04, 05 D2876 LOH 20, 21	Tourliner, Starliner, Lion's Star, Lion's Coach 792 X 860 X 66	
<b>76571</b>	D2066LOH, D2676LOH	P11, P12, Starliner - P14, P15, P16 Cityliner - P20, P21, P22 Tourliner - P81, P82 Skyliner - R07, R08, R09 Lion's Coach 732 X 931 X 64	

## Scania

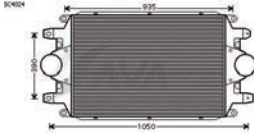
RÉF ATS	DÉSIGNATION	PARTICULARITÉS	
<b>95546</b>	DSC9.08, DSC11.08, DS11.73, DS11.34	Omnicity, Century K93/K113 1050 X 390 X 935	

## Temsa

RÉF ATS	DÉSIGNATION	PARTICULARITÉS	
<b>78583</b>	Opalin Man D0836LOH	Opalin dep 2006 630 X 659 X 62	
<b>78585</b>	Box, Tourmalin Cummins ISBE	Box, Tourmalin dep 2007 550 X 812 X 62	
<b>68699</b>	Safara, DAF	Safari HD, RD 554 X 852 X 52	

## Vanhool

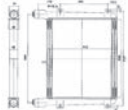
RÉF ATS	DÉSIGNATION	PARTICULARITÉS	
<b>67416</b>	Man D2866LOH	T9 1000 X 777	
<b>95544</b>	Man	606 X 537 X 62	

## Volvo

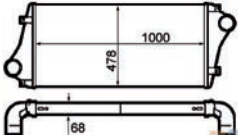
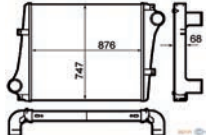
RÉF ATS	DÉSIGNATION	PARTICULARITÉS	
<b>94357</b>	D7C, D12H, D12A	7700, B7TL, B12M 1000 X 475 X 68	
<b>95545</b>	D9B, D12H	B9, B12M, 9500, 9700, 9900 dep 08/08 875 X 745 X 68	

## Volkswagen Crafter

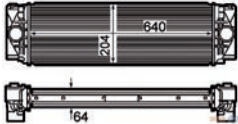
RÉF ATS	DÉSIGNATION	PARTICULARITÉS	
<b>78613</b>	2,5TDI BJJ, BJK, BJL, BJM	Crafter 30-35 dep 04/06 40 X 204 X 64	



### Bova, Vanhool

RÉF ATS	DÉSIGNATION	PARTICULARITÉS	
<b>65884</b>	DAF Euro 3, 4 XE280C, XE375C, MX265, MX300, MX340, MX375	Bova Futura FHD, Temsa, DAF, Vanhool T9	

### Evobus

RÉF ATS	DÉSIGNATION	PARTICULARITÉS	
<b>68715</b>	OM447 HLA, OM441, OM442, Euro 1, 2	0345, 0405, 0408, 0404, 0350	
<b>76890</b>	OM611.987, OM611.981, OM612.981	Sprinter dep 04/2000 jsq 05/06 208, 308, 408 CDI - 211, 311, 411 CDI - 213, 313, 413 CDI - 216, 316, 416 CDI L142 X 80 X 39	
<b>78646</b>	OM457LA, OM457HLA	S415-417 GTHD, S415-417HD, HDH, S412- 416UL, 0350 Euro 3, Citaro Euro 3, 4, Integro New, 0550 Euro 3, Connecto Euro 3, Tourismo 15, 16, 17 RHD Euro 4, 5, 0580 Travego Euro 3, 4, 5	
<b>78648</b>	OM906LA, OM926LA, OM906HLA	0510 Tourino, 0560 Intouro Euro 4, 5, 0530 Citaro Euro 2	

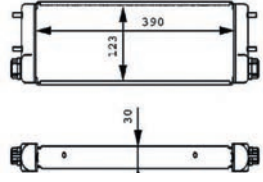
### Iveco/Irisbus

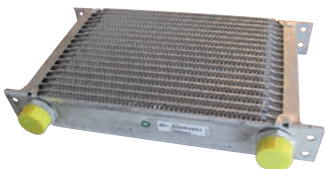
RÉF ATS	DÉSIGNATION	PARTICULARITÉS	
<b>76884</b>	Cursor F2BE Tector	GX327, 427, Agora, Recreo C955/ Axer, Evadys, Ares, Arway, Crossway, Recreo New, Citelis, Créalis, Crossway LE Euro 5	
<b>73351</b>	Cursor 10	Arway 15 m, Evadys HD, Magelys HD, HDH	
<b>40625</b>	FR1 MIDR 0622045	FR1	

## Iveco/Irisbus

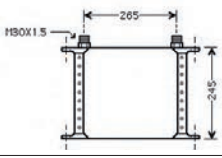
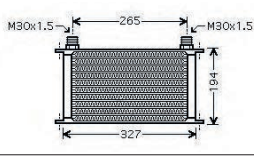
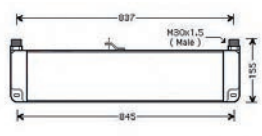
RÉF ATS	DÉSIGNATION	PARTICULARITÉS	
<b>70358</b>	Radiateur d'huile Moteur 062045 cursor 8 F2BE Euro 3	Irisbus Agora, Agora Line, Agora GNV dep 2002	
<b>75166</b>	Radiateur d'huile Moteur MIDR 062356A41 MIDR 0622045M41, R41 Euro 2	Irisbus Iliade, Ares court avec boîte manuelle	
<b>78005</b>	Radiateur d'huile Moteur DCI Euro 3	Irisbus Iliade, Ares	

## Man, Fast

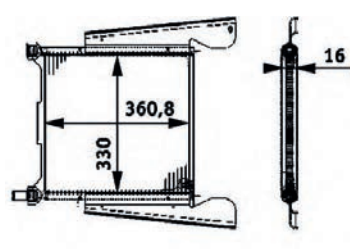
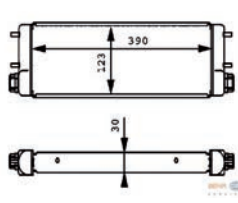
RÉF ATS	DÉSIGNATION	PARTICULARITÉS	
<b>65501</b>	Radiateur d'huile Moteur D0826LUH01-06/08/10/12/13, D0836LUH01/02, D2876LOH02/03/04/05, D2066LOH01-08/10-12, D2676L OH27-29/32/33/34/35/37/38, D2066LH01-05/07-09/11-18/21 - 24/26 - 28/41-43/47/48	Fast Scoler 3 A91, Syter A51, Man Lion's City A20/A21/A23/A24/A25/A37/A39/A47, Lion's coach R07/R08/R09, Lion's Regio R12, R13, R14, Neoplan Starliner P11, P12, Cityliner P14, P15, P16, Tourliner P20, P21, P22, Trendliner P23, P24	
<b>76884</b>	Radiateur d'huile Moteur 2866LOH20-26/27-29/30- 35/37/38 - D0826LUH01 - 06/08/10/12/13 390 X 123 X 30	Man A01 VEL 313/353, A04 VEL 313/353, A23 Lion's City, A69 18-220HOCL/R-NL, A51 18-310/350/370/400/420/460 HOCLR - Fast Syter	

## Scania

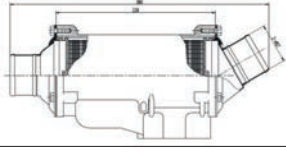
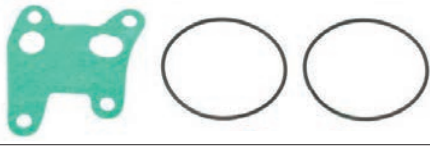
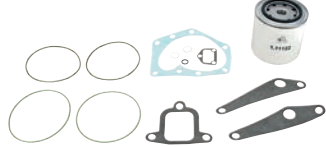
RÉF ATS	DÉSIGNATION	PARTICULARITÉS	
<b>91109</b>	Radiateur d'huile Moteur DS-DSC11	Scania Irizar Century, Scania I4/I6	
<b>91110</b>	Kit de joints radiateur d'huile Moteur DSC11	Scania Irizar Century, Scania I4/I6	
<b>91111</b>	Kit de joints avec filtre	Scania Intercentury, Scania I4	

### Scania

RÉF ATS	DÉSIGNATION	PARTICULARITÉS	
<b>91112</b>	Joint radiateur d'huile	Scania Intercentury, Scania I4	
<b>91113</b>	Joint radiateur d'huile	Scania Irizar Century, Scania I4/I6	

### Volvo

RÉF ATS	DÉSIGNATION	PARTICULARITÉS	
<b>91095</b>	Refroidisseur d'huile Moteur D9A/B, D12A/B	Volvo 9500/9700/9900 B12	
<b>91096</b>	Kit de joints refroidisseur d'huile Moteur D9B, DH12C/D		
<b>91097</b>	Bague d'étanchéité refroidisseur d'huile Moteur D9A/B, D12A/B/C/D, DH12C/D, DH12E GEN6, D13C/F/H	Volvo 9500/9700/9900 B12	
<b>91099</b>	Bague d'étanchéité refroidisseur d'huile Moteur DH12C/D DH12E GEN 6		
<b>91100</b>	Bague d'étanchéité refroidisseur d'huile Moteur D9A/B, D13F		

### Volkswagen

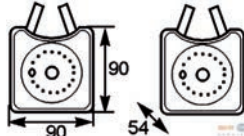
RÉF ATS	DÉSIGNATION	PARTICULARITÉS	
<b>76892</b>	Radiateur d'huile Moteur BJM 56 X 92 X 92	Volkswagen Crafter 30-35 dep 05/06 jsq 07/11	



## Noyau ventilateur Evobus

RÉF ATS	APPLICATION	DIAMÈTRE	MOTEUR
<b>43433</b>	Bova FHM	Ø 720	Mercedes
<b>35147</b>	Evobus 215HD, HR, 216HDS	Ø 700	OM 422A, LA
<b>35312</b>	Evobus 215UL, SL, HR, H	Ø 650	447H, HA, D2866UH, 422, 442, 421
<b>38741</b>	Evobus 0303, 0330	Ø 650	OM442A, OM442
<b>36837</b>	Evobus 0315	Ø 680	
<b>58069</b>	Evobus 0345 - Euro 2, 0405, 0408	Ø 630	OM447HLA
<b>40314</b>	Fast Scoler 1, 2 - Euro 1, 2	Ø 640	
<b>37286</b>	Irisbus PR100-2, PR180-2	Ø 650	
<b>73111</b>	Iveco Eurorider, Eurocite	Ø 660	
<b>36860</b>	Neoplan N316, N116	Ø 650	D2866LOH07, OM401LA, OM441LA, 402LA
<b>47967</b>	Scania K113	Ø 650	
<b>37670</b>	Vanhool A500	Ø 600	
<b>35988</b>	Vanhool T815A, T816, Altano	Ø 700	
<b>37052</b>	Volvo B10M	Ø 620	
<b>47510</b>	Volvo B10B, GX57	Ø 650	
<b>37057</b>	Volvo B12	Ø 680	



## Noyau ventilateur Evobus

RÉF ATS	APPLICATION	DIAMÈTRE	MOTEUR
<b>62814</b>	Sprinter 308, 311, 313, 316 411, 413, 416 CDI	Ø 160	OM611.981, OM611.987, OM612.981
<b>62813</b>	Vario 0812, 0814, 0815, 0818 Point de commutation 85°	Ø 160	OM904LA
<b>62812</b>	Tourino 0510 Euro 3	Ø 203	OM906LA
<b>40503</b>	0350, 0404 Euro 2		OM402LA



## Noyau ventilateur Linnig

RÉF ATS	VUE	APPLICATION	TYPE	MOTEUR
<b>51361</b>	1	Evobus Setra 315 Euro 2, 0550 Integro	LA12045Y	OM447HLA, OM441LA
<b>57274</b>	2	Evobus 315 UL, GT, NF, H - 0550 Integro	LA12067Y	OM447HLA, OM441LA, 442LA
<b>65424</b>	3	Evobus Setra 315 Euro 3	LLW10027Y	OM457HLA (renvoi d'angle type Vario - Comp)
<b>52832</b>		Evobus Setra 315 GTHD, H, HD	LA120116Y	OM442LA
<b>51361</b>	1	Evobus Setra 315 H, HD, HDH	LA12045Y	OM442LA, OM441LA
<b>57840</b>		Evobus Mercedes 0405 châssis 357090, 480, 484, 486, 488, 589	LA12079	OM447H



## Noyau ventilateur Linnig

RÉF ATS	VUE	APPLICATION	TYPE	MOTEUR
<b>65424</b>	3	Evobus série 400, Top Class, Confort Class, 0530 Citaro, New Tourismo (Ø 74 mm), 0580 Travego, Evobus Setra 412 UL - 416 UL	LLW10027Y	OM457LA, HLA, renvoi d'angle
<b>71566</b>	4	Mercedes 0550 Euro 2	LA12012Y	OM447HLA
<b>58557</b>	5	Mercedes 0350 Euro 3, 0560 Intouro, 0510 Tourino	LA120129Y	OM457LA, OM457HLA
<b>71566</b>	4	Neoplan Starliner, Centroliner N4416, Skyliner N112, N316K, SHD	LA12012Y	Man
<b>58557</b>	5	Neoplan Euroliner	LA120129Y	D2866LUH
<b>62840</b>		Neoplan Euroliner	LA120101Y	OM441LA
<b>88482</b>		Otokar Vectio 290T		Man D0836LOH
<b>49053</b>		Vanhool T9, TL Euro 3, T9 CL Euro 2	Version pneumatique	Man D2866LOH, D2866LUH20
<b>50998</b>		Vanhool T915, T916 Acron, Alicron, T916 Altano, T917 Astron, T924 Astromega Euro 3	LA12087Y	Man D2876LOH 01/02, D2866LOH29 DAF XE315C
<b>50998</b>		Vanhool T915, T916 Alicron, Acron, CL Euro 4, 5	LA12087Y	Man D2066LOH 03/07 DAF MX300S2 Euro 5 DAF PR228S2/265S Euro 5
<b>73035</b>		Vanhool T916, T917 Astronef	Ø 226	Man D2676LOH26/27 DAF MX340U1/340U2/375U1



## Pompe hydraulique ventilateur

RÉF ATS	APPLICATION	MOTEUR	VUE
<b>64838</b>	Bova FHD	1284027	1
<b>47987</b>	Evobus 0530 Citaro Euro 2	OM906LA	2
<b>47989</b>	Evobus 0530 Citaro Euro 3	OM457HLA	
<b>64937</b>	Evobus 0530 Citaro Euro 4 châssis 628290	OM457HLA	
<b>64933</b>	Evobus 0530 Citaro Euro 4 Châssis 628.085, châssis 628.185, 285	OM457HLA	4
<b>73116</b>	Evobus S415-416 NF	OM457HLA	
<b>69163</b>	Irisbus Recreo C935 Euro 2	Renault	
<b>69766</b>	Irisbus Recreo, Axer, Evadys, Ares, Arway Euro 3	Iveco cursor F2B	5
<b>65977</b>	Irisbus Iliade, ares, agora	MIDR Renault	3
<b>69766</b>	Temsa Safari, Box	DAF, XE, MX, PR	5
<b>69766</b>	Vanhool T9	Man	5



## Pompe hydraulique moteur

RÉF ATS	VUE	APPLICATION	MOTEUR
<b>64935</b>	1	Evobus 0530 Citaro Euro 3 0345 connecto Euro 3	OM457 HLA
<b>55376</b>	2	Irisbus Recreo, Axer, Agora	Cursor 8F2B
<b>73118</b>	3	Fast syter A51, Stylus A53	Man
<b>73117</b>	4	Fast scoler A91	Man
<b>81610</b>		Fast Starter LE A69	Man D0836LUH 51-58/60-68/70-74
<b>73118</b>	3	Man Lion's city A21, A23, A26, Man A10, A11, A12, A13, A19, A21, A22, A30, A51, A53, A55, A59, A66, A81	Man
<b>73117</b>	4	Man A63, A74, A75, A76, A77, A82, A83, Man A72 SUE Pionnier, Man Lion's coach R07, R08, Tourliner P21, P22, Starliner P12	Man
<b>73117</b>	4	Temsa safari	Man D2866LOH

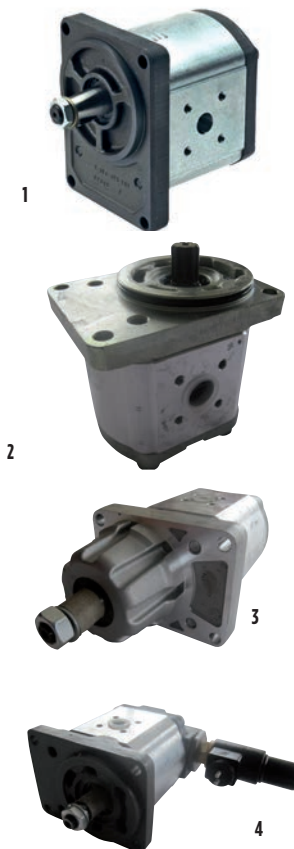

## Électrovanne de commande hydraulique

RÉF ATS	APPLICATION	MARQUE
<b>86320</b>	Irisbus Agora, Citelis, Cityclass, GX317, GX427, GX327	Bosch
<b>73747</b>	Irisbus Evadys, Crossway LE, Recreo, Crossway, Arway	Bosch
<b>71977</b>	Irisbus Ares, Iliade, FR1	HPI
<b>73286</b>	Tourismo, New châssis 632 Citaro, Integro New châssis 633	Bosch



## Boîte de commande ventilateur

<b>90433</b>	Irisbus Ares, Axer, Arway, Recreo, Evadys Moteur Cursor	Bosch
--------------	--	-------



### Evobus

RÉF ATS	DÉSIGNATION	PARTICULARITÉS	
<b>73808</b>	415-416 GTHD, New Turismo 15, 16, 17 RHD, Integro New 0350 Euro 3, 412UL, 415UL, 416UL, Citaro Low Entry Euro 5	OM457LA Ø 750 mm - 8 pales	
<b>76076</b>	315 NF, 415-416 NF	OM457HLA Ø 654 mm - 8 pales	
<b>78739</b>	Connecto Euro 3, Citaro 0530	OM457HLA Ø 600 - 8 pales	
<b>64939</b>	Citaro 0530 Euro 3, 4, 5	OM457HLA Ø 750 - 8 pales	
<b>65240</b>	315 HD	OM442LA	
<b>71745</b>	0814-0815 Vario, Mediano	OM904LA Ø 488 mm - 9 pales	

### Iveco/Irisbus

RÉF ATS	DÉSIGNATION	PARTICULARITÉS	
<b>73101</b>	Iliade TE, RT, TEX, RTX, GTX - Ares	Ø 720 mm - Moteur MIDR 0622045M41, MIDR 062356R41	
<b>73107</b>	Recreo, Axer C955, C956, Arway, Evadys, Eurorider 33 Euro 4, GX127, Crossway, Recreo New, Ares Crossway LE Euro 5	Tector Cursor 8 F2B Ø 704 mm - 8 pales	
<b>73104</b>	Midys, Midirider	Tector F4A Ø 600 mm - 8 pales	
<b>78741</b>	Magelys, Domino HD, HDH, Arway 15M, Evadys Hd, Eurorider 38, 45	Cursor 10 F3AE 3682 Ø 711,2 mm - 9 pales	
<b>76076</b>	Citelis, Crealis, GX327, GX427	Moteur Cursor F2B Ø 654 mm - 8 pales	
<b>73110</b>	Iveco Euroschool, CC130E24, CC150E24	Moteur Tector F4AE Ø 600 mm	

### Man, Fast

RÉF ATS	DÉSIGNATION	PARTICULARITÉS	
<b>73108</b>	Man A51, Fast Syter A21, Lion'S City	Ø 720 mm - 8 pales Man D2866 LOH Euro 3	



## Man, Neoplan, Fast

RÉF ATS	DÉSIGNATION	PARTICULARITÉS	
<b>73109</b>	Neoplan Starliner P11, P12 Cityliner P14, P15, P16 - Tourliner P20, P21 - Skyliner PB1, PB2 Man R02, R03 Lion'S Star - R07, R08, R09 Lion'S Coach - R12, R13, R14 Lion'S Regio - Man A72 Pionnier SUE, Man A91 Fast Scoler	D0836LOH 01/02/03/04, D00836LOH 51-58/62/63, D2066LUH 01-05/07/08/09/11- 18/21-24/26-28/41-43/47/48, D2876LOH, D2066LOH 01-08/10-12 Ø 754 mm	

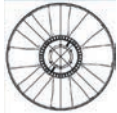

## Neoplan, Man, Fast

RÉF ATS	DÉSIGNATION	PARTICULARITÉS	
<b>70893</b>	Centroliner, Lion'S City A21, A23, Man châssis A91, R07, R08 Lion'S Coach, Fast Scoler 3 châssis A 91	Ø 704 mm - 9 pales	

## Temsa



RÉF ATS	DÉSIGNATION	PARTICULARITÉS	
<b>73106</b>	Safari HD	Moteur DAF, Moteur XE, MX Ø 704 mm - 8 pales	
<b>65987</b>	Temsa Safari	Ø 712 mm - 9 pales Moteur Man D2866LOH	

## Vanhool

RÉF ATS	DÉSIGNATION	PARTICULARITÉS	
<b>62238</b>	Vanhool T9	Ø 600 mm - 9 pales 12 trous de fixation	
<b>48772</b>	Vanhool T8, Gamme A Urbain	Ø 600 mm - 9 pales 6 trous de fixation	

## VASES D'EXPANSION

### BMC

RÉF ATS	DÉSIGNATION	PARTICULARITÉS	
<b>89948</b>	Vase noir	BMC Probus, Alyos	
<b>81914</b>	Tube de niveau		
<b>79137</b>	Bouchon		
RÉF ATS	DÉSIGNATION	PARTICULARITÉS	
<b>90475</b>	Vase noir	BMC Probus	

### Evobus

RÉF ATS	DÉSIGNATION	PARTICULARITÉS	
<b>56250</b>	Vase transparent	Evobus 0345 Euro 3, 0530 Citaro OM457HLA Euro 3	

### Evobus

RÉF ATS	DÉSIGNATION	PARTICULARITÉS	
<b>52301</b>	Vase noir 690 X 246 X 156	Evobus 0303, 0340, 0345, 0404, 0405, 0408, 0350 Turismo, 0510, 0580, Intouro, Setra série 300 et 400, Neoplan N3316 Euro 3 OM501LA, Bova Futura, Tensa DAF moteur PE, PR	
<b>70572</b>	Sonde Niveau		
RÉF ATS	DÉSIGNATION	PARTICULARITÉS	
<b>58489</b>	Vase noir	Evobus 0530 Citaro dep 04/2000 Euro 2	
RÉF ATS	DÉSIGNATION	PARTICULARITÉS	
<b>94062</b>	Vase noir 630 X 380 X 220	Intouro, Citaro, Turismo Euro 6 OM936LA, OM470LA	
RÉF ATS	DÉSIGNATION	PARTICULARITÉS	
<b>79461</b>	Vase	Sprinter, Transfer dep 06/06 209, 211, 215, 218 CDI, 309, 311, 315, 318 CDI, 509, 511, 515, 518 CDI	
RÉF ATS	DÉSIGNATION	PARTICULARITÉS	
<b>81458</b>	Vase transparent	Evobus Vario, Mediano 0814, 0815	

### Iveco/Irisbus

RÉF ATS	DÉSIGNATION	PARTICULARITÉS	
<b>56434</b>	Vase métallique	Irisbus Recreo moteur Renault Euro 2	
<b>61184</b>	Bouchon de remplissage		
<b>54901</b>	Bouchon de dégazage		
RÉF ATS	DÉSIGNATION	PARTICULARITÉS	
<b>67969</b>	Nourrice d'eau	Irisbus R312	
RÉF ATS	DÉSIGNATION	PARTICULARITÉS	
<b>68031</b>	Vase	Irisbus Agora Line, Evadys, Recreo dep 2007, Crossway	
RÉF ATS	DÉSIGNATION	PARTICULARITÉS	
<b>68505</b>	Vase blanc	Irisbus GX327, GX427, Citelis	
RÉF ATS	DÉSIGNATION	PARTICULARITÉS	
<b>85947</b>	Vase bleu	Irisbus GX327, GX427, Citelis 589 X 460 X 197	

## Iveco/Irisbus

RÉF ATS	DÉSIGNATION	PARTICULARITÉS	
<b>93620</b>	Vase métallique	Irisbus Ares, FR1, Iliade, Agora Line	
<b>75032</b>	Vase transparent		
<b>61620</b>	Bouchon de remplissage - Grand		
<b>61621</b>	Bouchon de gazage - Petit		
<b>57871</b>	Sonde		
<b>76130</b>	Vase transparent	Irisbus Cityclass	
<b>70058</b>	Vase plastique Euro 4, 5		
<b>95543</b>	Vase Euro 6	Irisbus Magelys Pro HD, HDH, Arway, Crossway, Recreio, Crossway LE, Evadys H, HD	
<b>89719</b>	Vase	Irisbus Mago	

## Man, Fast, Otokar, Tamsa, Vanhool

RÉF ATS	DÉSIGNATION	PARTICULARITÉS	
<b>52902</b>	Vase noir	Fast Syter, Fast Starter LE A69, Man châssis 474, A54, A82, R33, R37, R39	
<b>73951</b>	Vase	Fast Scoler 4 moteur Renault	
<b>61689</b>	Vase	Neoplan P14, P15, P16 Cityliner, P20, P21, P22 Tourliner, P23, P24, P25 Trendliner, PB1, PB2 Skyliner, Man R07, R08, R09 Lion's Coach, R12, R13, R14, Lion's Regio, A20, A21, A22, A23, A24, A25, A27, A28, A37 Lion's City, Fast Jumbo, Scoler 3 A91, Man A51, Tamsa Safari Man Euro 4, Otokar Vectio	

### Man, Fast, Otokar, Temsa, Vanhool

RÉF ATS	DÉSIGNATION	PARTICULARITÉS	
<b>39928</b>	Vase noir	Neoplan Euroliner Euro 3, Vanhool T8, T9, Man SU, Temsa Safari Man Euro 3	

### Otokar

RÉF ATS	DÉSIGNATION	PARTICULARITÉS	
<b>88096</b>	Vase métallique	Otokar Navigo	
<b>87327</b>	Bouchon		
<b>87042</b>	Capteur niveau		

### Scania

RÉF ATS	DÉSIGNATION	PARTICULARITÉS	
<b>92131</b>	Vase	Scania 94/114	



### Temsa

RÉF ATS	DÉSIGNATION	PARTICULARITÉS	
<b>89949</b>	Vase	Temsa Box, Tourmalin moteur Cummins	
<b>72906</b>	Vase	Temsa Safari MD9 Euro 5 moteur MX DAF	
<b>65996</b>	Vase d'expansion noir	Temsa Safari HD, RD moteur Man	

### Vanhool

RÉF ATS	DÉSIGNATION	PARTICULARITÉS	
<b>36255</b>	Vase métallique	Vanhool T9	
<b>68158</b>	Tube de niveau		
<b>90121</b>	Vase métallique ovale	Vanhool T9 Euro 5, TX moteur DAF MX	NR

### Volvo

RÉF ATS	DÉSIGNATION	PARTICULARITÉS	
<b>79141</b>	Vase	Volvo B7F, L, R - B9L, M, R, S - B10B, B12B, B12M, B12R, B13R	
RÉF ATS	DÉSIGNATION	PARTICULARITÉS	
<b>78256</b>	Vase	Volvo B7, B9, B10L, B10B, 9700, 9900, GX217, GX417	

## Divers

RÉF ATS	DÉSIGNATION	APPLICATION	
<b>19596</b>	Bouchon vase d'expansion	Pression 50 KPA = 0,5 bar	
<b>32625</b>		Pression 70 KPA = 0,7 bar	
<b>22666</b>		Pression 100 KPA = 1 bar	

## Evobus, Man, Fast

RÉF ATS	DÉSIGNATION	APPLICATION	
<b>62500</b>	Bouchon vase d'expansion Vert	Pression 0,45 bars Evobus Citaro, 0345 Connecto, Setra 415 NF, Fast Scoler, Man Lion's Coach, Neoplan Trendliner, Tourliner, Cityliner, Skyliner, Starliner	

RÉF ATS	DÉSIGNATION	APPLICATION	
<b>52260</b>	Bouchon vase d'expansion	0,7 bar Evobus Integro, Intouro, Tourino, Setra 412-417 UL	

RÉF ATS	DÉSIGNATION	APPLICATION	
<b>42722</b>	Bouchon vase d'expansion	0,7 bar Evobus Integro, Intouro, Tourino, Connecto Euro 2, Turismo, Setra série 300, 412-417 UL	

RÉF ATS	DÉSIGNATION	APPLICATION	
<b>79996</b>	Bouchon vase d'expansion	Evobus Citaro	

## Iveco, Renault, Fast

RÉF ATS	DÉSIGNATION	APPLICATION	
<b>58075</b>	Bouchon vase d'expansion	Fast Scoler 2 Euro 3 Moteur Irisbus DCI	

RÉF ATS	DÉSIGNATION	APPLICATION	
<b>54900</b>	Bouchon de dégazage	0,04 MPA Irisbus Recreo Euro 2	

RÉF ATS	DÉSIGNATION	APPLICATION	
<b>22666</b>	Bouchon de remplissage	1 bar Irisbus Recreo New, Crossway, Agora, Ares, Iliade, FR1, Tracer	

### Iveco, Renault, Fast

RÉF ATS	DÉSIGNATION	APPLICATION	
<b>32625</b>	Bouchon de dégazage	0,7 bar Irisbus Recreo New, Crossway, Agora, Ares, Iliade, FR1, Tracer	

### Man, Vanhool

RÉF ATS	DÉSIGNATION	APPLICATION	
<b>43362</b>	Bouchon de radiateur	1 bar Man A10, 11, 12, 15, 21 - Lion's City, A51 (Fast Syter), A66, A72 (Man SUE 263, 283, 313) A78 (Lion's City), A91 (Fast Scoler)	

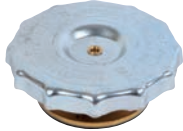
RÉF ATS	DÉSIGNATION	APPLICATION	
<b>53430</b>	Bouchon de radiateur	Man, Vanhool T8	

RÉF ATS	DÉSIGNATION	APPLICATION	
<b>40148</b>	Bouchon de remplissage	1 bar Man, Vanhool	

RÉF ATS	DÉSIGNATION	APPLICATION	
<b>72901</b>	Bouchon vase d'expansion	Man NL/NG/ND/NM, Lion's (DAF) Neoplan Trendliner, Skyliner, Cityliner, Starliner, Tourliner	

### Scania

RÉF ATS	DÉSIGNATION	APPLICATION	
<b>74669</b>	Bouchon vase d'expansion	Scania série 4, Irizar Century, PB F/K/L/N94, F/K114, K124	

### Volvo

RÉF ATS	DÉSIGNATION	APPLICATION	
<b>82033</b>	Bouchon vase d'expansion	Volvo 7700, 9500, 9700, 9900, B7L, B9R, B12B/M/R, B13R	
<b>82035</b>		0,75 bar Volvo 7700, 9500, 9700, 9900, B7L, B9R, B12B/M/R, B13R	

RÉF ATS	DÉSIGNATION	APPLICATION	
<b>78258</b>	Bouchon vase d'expansion	0,5 bars Volvo B12, B13R	
<b>78259</b>		0,5 bars Volvo B10L, GX217, GX417	

## Daf, Bova, Tamsa

RÉF ATS	DÉSIGNATION	PARTICULARITÉS	
<b>72903</b>	Sonde niveau refroidissement sur vase d'expansion Moteur DAF XE, MX	Bova futura, Tamsa safari	

## Iveco/Irisbus

RÉF ATS	DÉSIGNATION	PARTICULARITÉS	
<b>54904</b>	Transmetteur niveau d'eau MIDR 0622045 moteur Renault	Irisbus Recreo Euro 2	
<b>57871</b>	Transmetteur niveau d'eau Moteur Cursor F2BE Iveco	Irisbus Recreo, Axer Euro 3	
<b>71101</b>	Transmetteur niveau d'eau sur vase d'expansion	Heuliez GX317, Agora, Citelis, Ares (fabrication 72A), Fast scoler 1, 2	

## Evobus

RÉF ATS	DÉSIGNATION	PARTICULARITÉS	
<b>81736</b>	Sonde de température d'huile Moteur OM457 LA/HLA, OM502LA, OM501LA	Evobus Citaro, Setra série 400, Travego, Turismo, Integro	

## Man, Fast, Vanhool

RÉF ATS	DÉSIGNATION	PARTICULARITÉS	
<b>14348</b>	Transmetteur niveau d'eau sur vase d'expansion	Man A20, A21, Lion's City, A23, 24, 25, 26, 27, 28, 30, 31 - Lion's R07, R08, Neoplan Starliner, Tourliner, P21, P22, Centroliner, N4516, N4521, Fast Syter A51, Fast Stylus A53, Vanhool T9	

## Scania

RÉF ATS	DÉSIGNATION	PARTICULARITÉS	
<b>60617</b>	Transmetteur niveau d'eau M12 X 1,5	Scania série 3, 4	

## Vanhool

RÉF ATS	DÉSIGNATION	PARTICULARITÉS	
<b>14348</b>	Sonde de niveau d'eau Moteur DAF PR265U1 Euro 5	Vanhool TX	

### Volvo

RÉF ATS	DÉSIGNATION	PARTICULARITÉS	
<b>63368</b>	Sonde niveau refroidissement sur vase d'expansion	Volvo 7700, volvo 8700, 9700	

### CYLINDRES ACTIONNEURS, ÉCHAPPEMENTS ET EGR

### Iveco/Irisbus

RÉF ATS	DÉSIGNATION	PARTICULARITÉS	
<b>43931</b>	Cylindre arrêt pompe injection	Moteur MIDR 0622045 Tracer, FR1, R312, Iliade Euro 0, 1, 2, Ares, PR100, GX 317, Recreo Euro 2	

RÉF ATS	DÉSIGNATION	PARTICULARITÉS	
<b>93603</b>	Vanne EGR	Moteur F1CE0481FA - Moteur F1CE0481HC Moteur F1CE0481HA Iveco Daily 4 à partir de 05/06	

RÉF ATS	DÉSIGNATION	PARTICULARITÉS	
<b>93605</b>	Câble papillon Vanne EGR	Iveco Daily 4	

### Evobus

RÉF ATS	DÉSIGNATION	PARTICULARITÉS	
<b>586</b>	Cylindre de frein sur échappement Knorr	Moteur OM422, 442, 402, 401, 447, 441A, LA, HLA Euro 1, 2	

RÉF ATS	DÉSIGNATION	PARTICULARITÉS	
<b>46861</b>	Cylindre de frein sur échappement	Moteur OM441ALA, OM442ALA, OM447HLA, OM457 Mercedes, Neoplan M8 X 1	

## Evobus

RÉF ATS	DÉSIGNATION	PARTICULARITÉS	
<b>56082</b>	Cylindre de frein sur échappement	Moteur OM501LA, OM502LA, OM457HLA, OM457LA Evobus Setra série 300, 400 - 0550 Euro 3, Turismo, Travego, Citaro	

## Man, Vanhool

RÉF ATS	DÉSIGNATION	PARTICULARITÉS	
<b>42516</b>	Cylindre de frein sur échappement technomatik	Moteur Man Vanhool T9, Man 18, 370/420HOCL/R Ø 50 X 48 - M6 X 1	

RÉF ATS	DÉSIGNATION	PARTICULARITÉS	
<b>21571</b>	Cylindre de frein sur échappement technomatik	Moteur Man Vanhool T915CL, Man NUE 223/263/313, Man NG263, 313 NG, A20, A21, A22 Ø 40 X 48	

RÉF ATS	DÉSIGNATION	PARTICULARITÉS	
<b>68073</b>	Électrovanne de recyclage EGR	Moteur Man D2866 Euro 3	

## Scania

RÉF ATS	DÉSIGNATION	PARTICULARITÉS	
<b>65700</b>	Cylindre de frein sur échappement	Moteur DC-DSC9, DC11, DC-DSC12 Scania série 4 Moteur DC9, DC11, DC12 Scania série F/K/N	

RÉF ATS	DÉSIGNATION	PARTICULARITÉS	
<b>92748</b>	Cylindre de frein sur échappement	Moteur DC-DSC9, DC11, DC-DSC12 Scania série 4 - Moteur DC9, DC11, DC12, DC13 Scania série F/K/N	

RÉF ATS	DÉSIGNATION	PARTICULARITÉS	
<b>49239</b>	Cylindre actionneur injection	Scania série 4 F/K 114, K124	

### Pompe d'alimentation

RÉF ATS	DÉSIGNATION	PARTICULARITÉS	
<b>55373</b>	Support avec pompette	Cityclass, Eurorider, Proway, Agora	
<b>35931</b>	Support et pompette filtre à gasoil	Eurorider 26, 27, 29, 35, 38 - Euroschool Vehixel, Mago 2 moteur Iveco Cursor sans préchauffeur	
<b>69376</b>	Capteur filtre gasoil	Irisbus, Crossway, Recreo, Euro 4, 5	
<b>56314</b>	Pompe alimentation Moteur 062226, MIDR 0622045 Euro 0, 1, 2	Fast Scoler 1, 2 - R312, PR100-2, PR180-2	
<b>48833</b>	Pompe alimentation Moteur D2866LUH20-26/30/31, D2866LOH, LXOH 02/03/06/07/09, D2866LOH20-26/30/31	Evobus, Man	
<b>91073</b>	Pompe alimentation sur séparateur d'eau chauffant Moteur OM 457LA/HLA, OM926LA, OM501/502LA		
<b>92661</b>	Filtre séparateur complet chauffant avec pompe d'alimentation Moteur OM457LA/HLA, OM926LA, OM501/502LA	Evobus Intouro, Turismo, Setra 313-315 UL, GTHS Euro 3, Setra série 400	

## Pompe d'alimentation

RÉF ATS	DÉSIGNATION	PARTICULARITÉS	
<b>462</b>	Pompe automatique M16 X 1,5	Application diverses	
<b>35945</b>	Pompette ancien modèle alu	Application diverses	
<b>1516</b>	Pompette ancien modèle acier	Application diverses	
RÉF ATS	DÉSIGNATION	PARTICULARITÉS	
<b>1537</b>	Pompe avec support	Applications diverses	
<b>56632</b>			
RÉF ATS	DÉSIGNATION	PARTICULARITÉS	
<b>40822</b>	Joint simple cuivre	Sachet de 100 pièces 8 X 12 X 1	
<b>41233</b>		Sachet de 100 pièces 12 X 16 X 1,5	
<b>4334</b>	Joint double cuivre, moteur Man, Mercedes	Sachet de 25 pièces 10 X 9 X 6	
<b>4598</b>		Sachet de 25 pièces 10 X 9 X 8	

## Préfiltre

RÉF ATS	DÉSIGNATION	PARTICULARITÉS	
<b>1354</b>	Préfiltre complet	Applications diverses	
<b>1355</b>	Kit préfiltre	Cuve + filtre + ressort + joint	
<b>1517</b>	Préfiltre seul	Tamis seul	
<b>37277</b>	Préfiltre complet gros modèle	Applications diverses	
RÉF ATS	DÉSIGNATION	PARTICULARITÉS	
<b>460</b>	Kit clapet pompette d'alimentation	Clapet + ressort + joints	
RÉF ATS	DÉSIGNATION	PARTICULARITÉS	
<b>36462</b>	Kit préfiltre	Moteur Euro 2 Mercedes	
<b>55550</b>	Pompe complète		
RÉF ATS	DÉSIGNATION	PARTICULARITÉS	
<b>90307</b>	Pompe alimentation manuel Moteur OM926LA	Intouro, Turismo	
RÉF ATS	DÉSIGNATION	PARTICULARITÉS	
<b>1883</b>	Kit préfiltre	Applications diverses	
RÉF ATS	DÉSIGNATION	PARTICULARITÉS	
<b>40474</b>	Tuyau de retour	Ø 3,5 (vendu au mètre)	
<b>1539</b>	Bouchon de retour	Caoutchouc	
<b>38940</b>	Bouchon de retour	Renforcé	
RÉF ATS	DÉSIGNATION	PARTICULARITÉS	
<b>37313</b>	Pompe injection clapet trop plein	AM14 X 1,5 - 1,3 a 1,8 bar	
RÉF ATS	DÉSIGNATION	PARTICULARITÉS	
<b>467</b>	Support préfiltre gasoil	Applications diverses	

## Préfiltre

RÉF ATS	DÉSIGNATION	PARTICULARITÉS	
<b>55383</b>	Transmetteur de pression sonde	Citelis, GX327	
<b>91646</b>	Clapet anti retour Moteur OM457LA/HLA	Evobus Citaro, Setra série 300, 400, Turismo, Travego	

## POMPES DE GAVAGE

### Evobus

RÉF ATS	DÉSIGNATION	APPLICATION	
<b>92663</b>	Pompe alimentation OM904LA, OM926LA, OM906LA	Evobus Intouro, Citaro, Vario	
<b>92664</b>	Pompe alimentation OM457LA, HLA	Evobus Turismo, Travego, Citaro, Integro Setra série 300 Euro 3, série 400 Euro 4, 5	

### Iveco/Irisbus

RÉF ATS	DÉSIGNATION	APPLICATION	
<b>70741</b>	Pompe de gavage Moteur F2BE0682	Citelis, GX327, Citelis Line, Axer, Recreo, Arway, Eurorider, Evadys, Domino	
<b>56891</b>	Pompe de gavage sur pompe CP2 Bosch	Ares, Iliade moteur DCI 11 Euro 3 dep CAM D1 Bosch	

### Scania

RÉF ATS	DÉSIGNATION	APPLICATION	
<b>91072</b>	Pompe alimentation Moteur DC9 / DC11/ DC, DOC 12, DC, DT12 / DC13	Scania série 4, Century, I4, I6 Série F/K/N	
<b>92141</b>	Pompe de gavage Moteur DC-DT12, HPI	Scania série 4, série F/K/N	

### Neoman, Fast, Vanhool, Temsa

RÉF ATS	DÉSIGNATION	APPLICATION	
<b>91074</b>	Pompe de gavage Moteur Man D2876LOH20/21	Vanhool T9, Neoplan Starliner, Man Lion's Coach R07, R08, R09	
<b>91075</b>	Pompe de gavage Moteur Man D0836LOH51-58/62/63, D0836LOH40/41/50, D0836LUH40/41/50	Fast Scoler 3, Otokar Vectio, Man Lion's Regio, Man Lion's City	

### Neoman, Fast, Vanhool, Temsa

RÉF ATS	DÉSIGNATION	APPLICATION	
<b>65538</b>	Pompe de gavage Moteur Man D2066LUH01-05/07-09/17-18/21-24/26-28/41-43/47-48 D2066LOH01-08/10-12	Fast Scoler 3, Otokar Vectio, Man Lion's Regio, Man Lion's City	

### TUBES RACCORD PORTE INJECTEUR

### Evobus

RÉF ATS	DÉSIGNATION	APPLICATION	
<b>57849</b>	Tube raccord porte injecteur Moteur OM906LA, OM926LA, OM457HLA, OM457LA Euro 4, 5, OM502LA	Citaro, Tourino, Intouro, Vario, Turismo, Travego, Setra série 400	
<b>86785</b>	Joint torique		

### Iveco

RÉF ATS	DÉSIGNATION	APPLICATION	
<b>92674</b>	Tube raccord porte injecteur Moteur Tector F4AE0682	Mago, Recreo, Crossway, Citelis, GX 127, GX327 Hybrid, Midirider	







### Man

RÉF ATS	DÉSIGNATION	APPLICATION	
<b>79560</b>	Tube raccord porte injecteur Moteur D2066L UH01-05/07-09/11-18/21-24/26-28/41-43/47/48, D2066LOH01-08/10-12	Fast Scoler 3, Syter Euro 4, Vanhool T9 Euro 4, Man Lion's Coach Euro 4, Neoplan Tourliner Euro 4, Starliner Euro 4, Trendliner Euro 4, Temsa Safari Euro 4	
<b>63918</b>	Tube raccord porte injecteur Moteur D2876LOH02/03/04/05, D2866LOH27-29/32/33/34/35/37/38, D2866LUH 23/24/25/27-30/34-37/50-52, D2876LOH20/21	Fast Syter Euro 3, Vanhool T9 Euro 3, Man Lion's Coach Euro 3, Neoplan Tourliner Euro 3, Starliner Euro 3, Trendliner Euro 3, Temsa Safari Euro 3	
<b>92666</b>	Tube raccord porte injecteur Moteur D0836LOH40/41/50, D0836LOH50/51/52/53, D0836LOH51-58/62/63, D0836LUH40/41/50	Fast Scoler 3, Man Lion's City, Lion's Regio	

### Renault

RÉF ATS	DÉSIGNATION	APPLICATION	
<b>73657</b>	Tube raccord porte injecteur DCI 11	Iliade, Ares DCI Euro 3	

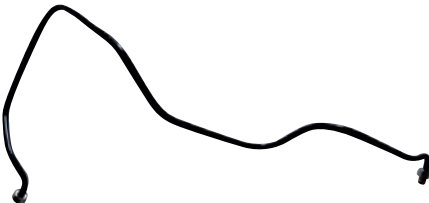

## Iveco/Irisbus

RÉF ATS	DÉSIGNATION	APPLICATION	
<b>55367</b>	Flexible gasoil Moteur Cursor F2BE Euro 3	Irisbus Agora, Citelis	
<b>67460</b>	Flexible gasoil Moteur Cursor F2BE	Irisbus Arway Euro 4, Crossway, Crossway LE, Recreo New, Evadys H, Eurorider 33	
<b>67459</b>	Flexible gasoil Moteur Cursor F2BE	Irisbus Arway Euro 4, Crossway, Crossway LE, Recreo New, Evadys H, Eurorider 33	
<b>55982</b>	Flexible gasoil Moteur Cursor F2B	Irisbus Citelis, GX327, 427, Cityclass 25, 29, 35, Crealis 12 m, 18 m	
<b>71798</b>	Flexible gasoil Moteur Cursor F2B	Irisbus Agora, Citelis, GX327, 427, Cityclass 25, 59, 35, Crealis 12 m, 18 m	
<b>58199</b>	Flexible gasoil Moteur Cursor F2B	Citelis Line	
<b>55374</b>	Flexible gasoil Moteur Cursor F2BE0682	Irisbus Recreo, Crossway, Cityclass 25, 29, 35, Euroclass 35	



### Iveco/Irisbus

RÉF ATS	DÉSIGNATION	APPLICATION	
<b>68901</b>	Flexible gasoil Moteur Tector F4AE	Mago 2, Recreo Euro 4, Crossway, GX127, Vehixel Euroschool	
<b>68898</b>	Flexible gasoil Moteur Tector F4AE	Vehixel, Euroschool, Midirider 27, Eurorider 27	
<b>68899</b>	Flexible gasoil Moteur Tector F4AE	GX127, Crossway, Crossway LE, Recreo Euro 4, Midirider 27, 30, Mago 2, Vehixel Euroschool	
<b>68900</b>	Flexible gasoil Moteur Tector F4AE	GX127, Crossway, Crossway LE, Recreo Euro 4, Midirider 27, 30, Mago 2, Vehixel Euroschool	
<b>56559</b>	Flexible gasoil Moteur Tector F4AE	Europolis, Midirider, Mago 2, 3	
<b>63178</b>	Flexible gasoil Moteur Tector F4AE	Midirider 24, 27, Proway, Proxys, Mago 2, 3	
<b>63250</b>	Flexible gasoil Moteur Tector F4AE	Midirider 24, 27, Proway, Proxys, Mago 2, 3	
<b>63251</b>	Flexible gasoil Moteur Tector F4AE	Europolis, Midirider 24, 27, Proway, Proxys, Mago 2, 3	



## Cummins, BMC, Tamsa, Otokar

RÉF ATS	DÉSIGNATION	APPLICATION	
<b>80996</b>	Sonde nox Moteur Cummins	Probus, Alyos 250 CV	
<b>82012</b>		Probus, Alyos 285 CV, Euro 5 Tourmalin, Navigo	
<b>82011</b>	Sonde de température Cummins	BMC, Tamsa	
<b>88065</b>		Otokar Navigo	

## Evobus

RÉF ATS	DÉSIGNATION	APPLICATION	
<b>78645</b>	Sonde nox	Evobus Turismo, Intouro, Turismo New, Citaro, Travego, 415-419GTHD	
<b>45253</b>	Sonde Lambda	Evobus 0405	
<b>63881</b>		Evobus 0530 Citaro	

## Iveco, Irisbus

RÉF ATS	DÉSIGNATION	APPLICATION	
<b>52546</b>	Sonde Lambda	Irisbus Agora, Citelis	
<b>66156</b>	Sonde nox Continental Euro 4, 5 Moteur Cursor et Tector	Domino HD, HDH, Magelys HD, HDH, Recreo dep 2007, Crossway, Citelis, GX127, 327, 427, Evadys Euro 4, Vehixel Euroschool, Arway Euro 4, Mago moteur Tector	

## Man, Vanhool

RÉF ATS	DÉSIGNATION	APPLICATION	
<b>56771</b>	Sonde Lambda	Man, Vanhool	

RÉF ATS	DÉSIGNATION	RÉF CONSTRUCTEUR	APPLICATION	
<b>58241</b>	Injecteur gaz	<b>51131150038</b>	Irisbus F2B Cursor Agora, Citelis, GX327, Man	
<b>64854</b>	Injecteur gaz Moteur Euro 3	<b>5001859941</b>	Irisbus Agora GNV	
<b>72548</b>	Bougie gaz 14FR4 BERU	<b>A3761597203</b>	Evobus Citaro 0530	
<b>64310</b>	Bougie gaz Bosch FR5DP	<b>1369274</b>	Heuliez GX317 Moteur DAF	
<b>43741</b>	Bougie gaz RN7961	<b>5010295710</b>	Irisbus Agora	
<b>63606</b>	Bougie gaz BERU	<b>5010438495</b>	Irisbus Agora	
<b>56772</b>	Bougie gaz NGK	<b>504082651</b>	Irisbus Iveco	
<b>72526</b>	Bougie gaz GE5-1	<b>51259230049</b>	Man	
<b>38696</b>	Bougie gaz BERU	<b>1343069</b>	Vanhool Moteur DAF	
<b>53991</b>	Câble de bougie	<b>51254094001</b>	Man, Vanhool	
<b>64846</b>		<b>5001859408</b>	Irisbus Agora GNV	
<b>64308</b>	Bobine d'allumage moteur gaz	<b>298185</b>	Volvo/Heuliez	
<b>64691</b>		<b>504085566</b>	Heuliez GX317	
<b>64309</b>		<b>1300478</b>	Heuliez GX317 moteur DAF	
<b>64847</b>		<b>5001859416</b>	Irisbus Euro 3	
<b>69412</b>		<b>51259190016</b>	Man NL 243	
<b>62163</b>	Prolongateur de bobine d'allumage	<b>504374142</b>	Citelis CNG	

## > ENVIRONNEMENT MOTEUR

RÉF ATS	DÉSIGNATION	RÉF CONSTRUCTEUR	APPLICATION	
<b>69454</b>	Valve de réglage au ralenti alimentation d'air	<b>500359005</b>	Irisbus Agora GNV, GX327, Citelis	
<b>62808</b>	Débimètre d'air	<b>504074171</b>	Agora GNV	
<b>62706</b>	Détendeur gaz	<b>504224810</b>	Citelis CNG	
<b>68491</b>	Détendeur gaz Woodward	<b>5010352503</b>	Agora	
<b>64475</b>	Filtre gaz après détendeur	<b>5001018763</b>	Agora GNV	
<b>78396</b>	Filtre capteur pression admission	<b>5006155481</b>	Agora GNV, GX317GNV	
<b>64474</b>	Flexible détendeur gaz	<b>504074784</b>	Agora GNV, Citelis CNG	
<b>68124</b>	Moteur de survitesse	<b>5010438374</b>	Agora GNV	

RÉF ATS	DÉSIGNATION	RÉF CONSTRUCTEUR	APPLICATION
<b>64329</b>	Injecteur pompe moteur Cursor 8 F2BE	<b>504100287</b>	Irisbus Recreo, Arway, Crossway, Citelis
<b>60648</b>	Injecteur pompe moteur Cursor 8	<b>500380884</b>	Irisbus
<b>64331</b>	Injecteur pompe moteur Cursor F3AE0682	<b>504287070</b>	Irisbus Evadys Euro 4



RÉF ATS	DÉSIGNATION	RÉF CONSTRUCTEUR	APPLICATION
<b>70895</b>	Porte injecteur common rail D2066LUH	<b>51101006064</b>	Fast Scoler 3 Euro 4
<b>60653</b>	Porte injecteur common rail DCI6WJ01 Euro 3	<b>5010450532</b>	Fast Scoler 2
<b>58399</b>	Porte injecteur common rail Tector F4AE	<b>2830957</b>	Heuliez GX117
<b>52956</b>	Porte injecteur common rail DCI11	<b>5010477499</b>	Irisbus Iliade, Ares
<b>72922</b>	Porte injecteur common rail Tector F4AE682 Euro 4	<b>504091504</b>	Irisbus Recreo, Crossway, GX127, Midirider



RÉF ATS	DÉSIGNATION	RÉF CONSTRUCTEUR	APPLICATION
<b>37261</b>	Porte injecteur échange standard Moteur 062045 Moteur MIHS0622045b	<b>5000789576</b>	Irisbus GX317, R312, Tracer
<b>64313</b>	Porte injecteur échange standard Moteur 062356A41 KBEL100P123	<b>5001838576</b>	Irisbus Ares, Iliade 380 CV
<b>64314</b>	Porte injecteur échange standard Moteur 062045R41 KBEL100P202	<b>5001838555</b>	Irisbus Ares, Iliade 300 CV
<b>47958</b>	Porte injecteur échange standard Moteur 062045M41 KBEL100P64	<b>5001838684</b>	Irisbus Ares, Iliade 340 CV
<b>64315</b>	Porte injecteur échange standard Moteur MIHR062045A	<b>5001838502</b>	Irisbus Recreo, Tracer
<b>55328</b>	Porte injecteur échange standard Moteur OM447HLA, OM447.949 Euro 2	<b>A0030179221</b>	Evobus 0345 (157kw) 0550, U, H
<b>64335</b>	Porte injecteur échange standard Moteur OM447HLA, OM447.960	<b>A0030176021</b>	Evobus 0345 (184kw)
<b>56461</b>	Porte injecteur échange standard Moteur OM441LA	<b>A0040172921</b>	Evobus 0550
<b>43167</b>	Porte injecteur échange standard Moteur OM402.970LA	<b>A0030175721</b>	Evobus 0350
<b>56461</b>	Porte injecteur échange standard Moteur OM447HLA	<b>A0040172921</b>	Evobus 315UL
<b>64336</b>	Porte injecteur échange standard Moteur OM442LA jsq moteur 860061	<b>A0040177121</b>	Evobus 315HD, HDH, GTHD
<b>56461</b>	Porte injecteur échange standard Moteur OM442LA dep moteur 860062	<b>A0040172921</b>	Evobus 315HD, HDH, GTHD S317HDH
<b>90311</b>	Pompe PLD ES - Bosch	<b>A028074590</b>	OM457LA, 457HLA, 502LA, 501LA
<b>90308</b>	Pompe PLD ES - Bosch	<b>A0280746902</b>	OM926LA





## BMC

RÉF ATS	DÉSIGNATION	APPLICATION	
<b>80190</b>	Bouchon AD Blue	BMC Midilux	
<b>86293</b>		BMC Probus Euro 5	

## DAF, Evobus

RÉF ATS	DÉSIGNATION	APPLICATION	
<b>79438</b>	Bouchon AD Blue avec clé Ø 40	Setra 411-415HD, Setra 431DT, Travego, Turismo New, Integro New, Intouro, Setra S415-416GT, Setra 415-417GTHD, Tourino, Setra 412-416UL, DAF, Bova, Temsa	

## Iveco/Irisbus

RÉF ATS	DÉSIGNATION	APPLICATION	
<b>74345</b>	Bouchon sans clé AD blue Ø 60	Irisbus, Arway Euro 4, Citelis, Cityclass, Crossway, Euro rider, Evadys, GX127, GX327, Magelys, Midirider, Recreo	
<b>65325</b>	Bouchon avec clé AD blue Ø 60		

## Man

RÉF ATS	DÉSIGNATION	APPLICATION	
<b>90989</b>	Bouchon AD Blue	Man Lion's City, Lion's Coach R07, R08, R09, Lion's Regio, Cityliner, Starliner, Tourliner	

## Otokar

RÉF ATS	DÉSIGNATION	APPLICATION	
<b>88068</b>	Bouchon AD Blue	Otokar Navigo	
<b>88070</b>	Bouchon vidange AD Blue		

## Vanhool

RÉF ATS	DÉSIGNATION	APPLICATION	
<b>71052</b>	Bouchon AD Blue	Vanhool T9	

## Volvo



RÉF ATS	DÉSIGNATION	APPLICATION	
<b>91028</b>	Bouchon AD Blue	Volvo B9S/TL, B12B/M, B13R, 9700, 9900	





RÉF ATS	DÉSIGNATION	APPLICATION	
<b>67185</b>	Sonde de température sur catalyseur	Recreo Crossway, Evadys Euro 4	
RÉF ATS	DÉSIGNATION	RÉF CONSTRUCTEUR	APPLICATION
<b>65641</b>	Module doseur d'air AD blue D Nox ancien montage	<b>41271148</b>	Irisbus Arway Euro 4, Citelis, Evadys H, HD, Magelys HD, Crossway, Recreo, Domino Euro 4
<b>74199</b>	Module doseur d'air AD blue D Nox nouveau montage	<b>5801392767</b>	Irisbus Citelis, Crealis, Magelys HD, HDH, Pro, New Domino, GX327, 427
RÉF ATS	DÉSIGNATION	RÉF CONSTRUCTEUR	APPLICATION
<b>77697</b>	Module d'alimentation AD Blue	<b>504200399</b>	Irisbus Recreo, Crossway
RÉF ATS	DÉSIGNATION	RÉF CONSTRUCTEUR	APPLICATION
<b>68385</b>	Injecteur AD blue	<b>503136267</b>	
RÉF ATS	DÉSIGNATION	APPLICATION	
<b>66705</b>	Filtre bouchon AD blue	Irisbus	
<b>57929</b>	Filtre AD blue	Irisbus, Recreo, Evadys, Crossway, Arway, Mercedes, Setra	
RÉF ATS	DÉSIGNATION	APPLICATION	
<b>58302</b>	Préfiltre AD blue	Irisbus, Recreo, Crossway	
RÉF ATS	DÉSIGNATION	APPLICATION	
<b>70437</b>	Jauge de niveau AD Blue	Midirider 30 Euro 4, Evadys H Euro 4, Crossway/ Recreo, Arway Euro 4, Crossway LE	
<b>81665</b>		BMC Probus Euro 4	
<b>80698</b>		BMC Probus Euro 5	
<b>90095</b>		Otokar Navigo	



> ENVIRONNEMENT MOTEUR

<b>RÉF ATS</b> <b>68641</b>	DÉSIGNATION Électrovanne AD Blue	APPLICATION Irisbus Recreo/Crossway, Evadys, VDL Bova, Vanhool TX DAF, Solaris Urbino, Tourino, Travego, Citaro, Integro New, Intouro, Turismo New, S431DT, S412-417UL, S415-416H, S411-415HD		
<b>RÉF ATS</b> <b>73182</b>	DÉSIGNATION Moteur doseur AD blue	APPLICATION Vanhool T9, Safari HD, RD, VDL Bova Futura, Magiq - Moteur PR228S, PR265S, MX300, MX340, MX375		
<b>RÉF ATS</b> <b>76833</b>	DÉSIGNATION Module alimentation AD Blue neuf	<b>RÉF CONSTRUCTEUR</b> <b>1818625</b>	APPLICATION Moteur DAF MX	
<b>RÉF ATS</b> <b>92134</b>	DÉSIGNATION Module alimentation AD Blue	<b>RÉF CONSTRUCTEUR</b> <b>1884225</b>	APPLICATION Scania Moteur DC09, DC12	
<b>79455</b>	Module doseur Ad Blue ASLA32	<b>A0001404139</b>	Evobus Mercedes OM457LA OM457HLA OM502LA OM926LA Intouro/Tourismo/Travego/Integro Série 400 Setra	
<b>89760</b>	Module doseur Ad Blue avec chauffage de diffuseur	<b>A0001404139</b>	Evobus Mercedes OM457HLA OM457LA OM501LA OM502LA OM926LA Intouro, Turismo, Travego, Integro, Série 400 Setra	
<b>70188</b>	Module Pompe AD Blue	<b>A0001400578</b>	Evobus Mercedes Intouro, Citaro, Tourino, Integro, Turismo, Série 400 Setra	

### Potentiomètres accélérateurs



RÉF ATS	DÉSIGNATION	APPLICATION	
<b>EVOBUS</b>			
<b>74888</b>	Potentiomètre accélérateur VDO	0345 Euro 2, 0405	
<b>91030</b>	Potentiomètre accélérateur	Setra série 400, Intouro, Turismo, Integro, Citaro, Tourino - Châssis 410/444/613/628/629/632/633/634/671/685	

RÉF ATS	DÉSIGNATION	APPLICATION	
<b>IVECO/IRISBUS</b>			
<b>58056</b>	Potentiomètre accélérateur VDO	GX117, 317, 327, 427, Agora, Citelis	
<b>60632</b>	Potentiomètre accélérateur Bosch	Agora, Axer, Citelis, Recreo C955	
<b>44148</b>	Potentiomètre accélérateur Bosch	Agora Line, R312, Iliade, Ares	
<b>74496</b>	Potentiomètre accélérateur	Recreo New / Crossway, Anway, Evadys, Magelys, Domino	

RÉF ATS	DÉSIGNATION	APPLICATION	
<b>FAST, NEOMAN</b>			
<b>76612</b>	Potentiomètre accélérateur VDO	Scoler 2	
<b>57633</b>	Potentiomètre accélérateur Bosch	Fast Scoler 3 (A91) Euro 3, Syter (A51) Euro 3 - Man SUE 313 A72 Euro 3, Lion's City Euro 3	
<b>72487</b>	Potentiomètre accélérateur VDO	Fast Scoler 3 (A91) Euro 4, 5, Syter (A51) Euro 4, 5 - Man Lion's City, Starliner Euro 4, 5 - Tourliner Euro 4, 5 - Trendliner Euro 4, 5 - Cityliner Euro 4, 5 - Lion's Coach R07, R08, R09 Euro 4, 5 - Lion's Regio R12, R13, R14 Euro 4, 5	NR

RÉF ATS	DÉSIGNATION	APPLICATION	
<b>VANHOOL</b>			
<b>64290</b>	Potentiomètre accélérateur Bosch	T9 Euro 3, 4	
<b>76403</b>	Potentiomètre accélérateur	T9 Euro 5	



### Moteurs limiteurs de vitesse

RÉF ATS	DÉSIGNATION	APPLICATION	
<b>337</b>	Moteur limiteur de vitesse Bosch	Evobus série 300	
<b>37690</b>	Moteur limiteur de vitesse VDO	Irisbus FR1, Tracer	
<b>43903</b>	Moteur limiteur de vitesse Bosch	Irisbus Agora, Agora Line, Ares, R312, Iliade, GX317 Vanhool T9	

## DAF, Irisbus, Bova, Temsa

RÉF ATS	DÉSIGNATION	APPLICATION	
<b>66329</b>	Capteur de pression Moteur DCI 310/360/420 Moteur DAF PR265S, PE260C, PR228C, PR228S	Bova Lexio, Futura, Irisbus Ares, Iliade Euro 3, Temsa Box, Tourmalin	

## Evobus

RÉF ATS	DÉSIGNATION	APPLICATION	
<b>91083</b>	Capteur de pression de suralimentation Beru Moteur OM501LA, OM502LA, OM904LA, OM906HLA	Evobus Citaro, Setra 411, Setra 415-417HD/ HDH, Neoplan Euroliner	
<b>61944</b>	Capteur de pression et régime moteur 3,5 bars Moteur OM926LA, OM457HLA, OM457LA	Evobus Intouro, Tourino, série 400, Integro, Tourismo, Travego	
<b>61945</b>	Capteur de pression de suralimentation 4,0 bars Moteur OM457LA/HLA, OM501/502LA, OM904, OM906LA/ HLA, OM926LA	Evobus Intouro, série 300, 400, Integro, Tourismo, Travego, Citaro	



## Iveco, Irisbus

RÉF ATS	DÉSIGNATION	APPLICATION	
<b>55400</b>	Capteur de pression Moteur Iveco F2BE Cursor, F4AE	Irisbus Recreo, Crossway, Crealis, Cityclass, Arway, Magelys, Evadys, Citelis, GX327, GX427, GX127, Domino HD, HDH, Mago Moteur Tector, Vehixel Euroschool, Volvo B9L, R, S, TL, B13R, 9700/9500/9700/9900	

## Man, Fast, Temsa, Vanhool

RÉF ATS	DÉSIGNATION	APPLICATION	
<b>69464</b>	Capteur de pression Moteur D2066LUH, D2066LOH, D0836LUH, D2866LOH	Fast Scoler 3 châssis A91, Man Lion's coach R07, R08, Man Lion's Regio, Neoplan Trendliner, Tourliner, Starliner, Temsa Safari, Vanhool T9, A330, A320	





## Scania

RÉF ATS	DÉSIGNATION	APPLICATION	
<b>91082</b>	Capteur de pression suralimentation turbo	Scania série 4, K114, K124, Irizar Century, PB, Touring, I4, I6	
<b>91081</b>	Capteur de pression suralimentation turbo	Scania série 4, K114, K124, Irizar Century, PB, Touring, I4, I6	



## Volvo

RÉF ATS	DÉSIGNATION	APPLICATION	
<b>91080</b>	Capteur de pression - Moteur D9A340, D9B340, D9B380, DH12D340, D12D420, DH12E340, DH12E460	Volvo B9R/S/TL B12R, 9500/9700/9900	



### DAF, Bova, Temsa

RÉF ATS	DÉSIGNATION	APPLICATION	
<b>91087</b>	Capteur vilebrequin Euro 3,4 Moteur PE183C/S, PE228C, PR228S, PE265C, PR265S	Bova Lexio, Futura Temsa Box, Tourmalin	
<b>91084</b>	Capteur de position arbre à came Euro 3 Moteur XE250C, XE280C, XE315C/M, XE355C	Bova Futura, Magiq, Vanhool T9	
<b>91085</b>	Capteur d'impulsion vilebrequin à came Euro 4, 5 Moteur MX365, MX300, MX340, MX375	Bova Futura, Magiq, Temsa Safari, Vanhool T9	
<b>91086</b>	Capteur d'impulsion vilebrequin Euro 4, 5 Moteur MX265, MX300, MX340, MX375	Bova Futura, Magiq, Temsa Safari, Vanhool T9	

### Evobus

RÉF ATS	DÉSIGNATION	RÉF CONSTRUCTEUR	APPLICATION	
<b>91047</b>	Capteur de régime Moteur OM501/502LA	<b>A0001539520</b>	Evobus Setra série 400, 0350 Tourismo, 0580 Travego, Tourismo New. Sonde VDO	
<b>91048</b>	Capteur de régime Moteur OM457HLA, OM904LA, OM906LA/HLA, OM926LA	<b>A0011532120</b>	Evobus Setra série 400, Intouro, Citiro, Tourismo New	



### Iveco/Irisbus

RÉF ATS	DÉSIGNATION	RÉF CONSTRUCTEUR	APPLICATION	
<b>55381</b>	Capteur volant moteur Moteur F2BE0682	<b>5001850014</b> <b>504005575</b>	Irisbus Recreo, Axer, Ares, Agora, Arway, Crossway, Evadys, Domino, Eurorider, Cityclass	
<b>70920</b>	Capteur de régime Moteur Cursor F2BE	<b>504096645</b>	Irisbus Recreo, Crossway, Arway, Evadys	
<b>67555</b>	Générateur d'impulsion Moteur Tector F4AE	<b>4890189</b>	Irisbus Recreo, Crossway, GX127	
<b>66327</b>		<b>4890190</b>		

### Man

RÉF ATS	DÉSIGNATION	APPLICATION	
<b>62226</b>	Capteur de régime Moteur D2876LOH02/03/04/05, D2866LOH27-29/32/33/34/35/37/38, D2866LUH23/24/25/27-30/34-37/50-52, D0836LUH40/41/50	Man Lion's Coach, Lion's Regio, Neoplan Trendliner, Tourliner, Temsa Safari, Vanhool T9	



## Man

RÉF ATS	DÉSIGNATION	APPLICATION	
<b>57886</b>	Capteur de régime Moteur D0826LUH 01-06/08/10/12/13, D2866LOH20-26/30/31, D2866LUH20/21/22/26, D2876LOH01	Vanhool T9, A330, Temsa Safari, Man SUE, Fast	
<b>61364</b>	Capteur de régime Moteur D0836LOH40/41/50	Vanhool Urbain, Man Lion's City	
<b>64035</b>	Capteur de régime Moteur D2866LUH27-29/32/33/34/35/ 36/37/50-52, D0836LUH40/41/50, D0836LOH40/41/50, D2866LUH23/24/25/27-30/34-37/50-52	Vanhool T9, Urbain, Neoplan, Trendliner, Tourliner, Temsa, Safari, Man Lion's Regio	



## Renault

RÉF ATS	DÉSIGNATION	APPLICATION	
<b>75928</b>	Générateur d'impulsion vilebrequin	Fast Scoler 4	

## Scania

RÉF ATS	DÉSIGNATION	RÉF CONSTRUCTEUR	APPLICATION	
<b>92165</b>	Capteur de régime Moteur DC9, DC11, DC-DSC12, DC-DT12, DC13	<b>1457303</b>	Scania série 4, série F/K/N	
<b>92167</b>	Capteur de régime - Moteur DC9, DC11, DC-DT12, DC13			



## Volvo

RÉF ATS	DÉSIGNATION	RÉF CONSTRUCTEUR	APPLICATION	
<b>82031</b>	Capteur de régime Moteur DH12D340, D12D420, DH12E340, DH12E460, D10B360, D7C290	<b>3944124</b>	Volvo B9L/R/S/TL, B12B/M/R, B13R	
<b>91051</b>	Capteur de régime Moteur D9A340, D9B340, D9B380	<b>20508011</b>	Volvo B9R/TL/S B12R	
<b>86237</b>	Capteur de régime Moteur D9B300, D9B340, D9B380, D13C420, D13C460, D13C500	<b>20513343</b>	Volvo B9L/R/S/TL B12B/M, B13R 8700/9500/9700/9900	

### BMC

RÉF ATS	DÉSIGNATION	PARTICULARITÉS	
<b>80128</b>	Bouchon réservoir	BMC Probus, Midilux	

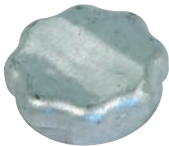
### Iveco/Irisbus

RÉF ATS	DÉSIGNATION	PARTICULARITÉS	
<b>54137</b>	Bouchon aluminium Ø ext 110 mm - Ø int 90 mm	Irisbus Recreo, Axer	
<b>66146</b>	Joint pour ATS 54137		
<b>60322</b>	Bouchon plastique avec clé Ø 80 mm	Irisbus Recreo nouveau modèle	
<b>65251</b>	Bouchon plastique sans clé Ø 80 mm	Irisbus Recreo, Axer, Ares	

RÉF ATS	DÉSIGNATION	PARTICULARITÉS	
<b>64694</b>	Bouchon avec clé Ø 72 mm	Irisbus Iliade, R312, Agora, FR1, Tracer, PR14, S53X	
<b>58443</b>	Bouchon sans clé Ø 72 mm		

RÉF ATS	DÉSIGNATION	PARTICULARITÉS	
<b>52985</b>	Bouchon fermeture à clé Ø 80 mm	Iveco Daily jsq 2002, Mago jsq 2002, Scolabus	

RÉF ATS	DÉSIGNATION	PARTICULARITÉS	
<b>52984</b>	Bouchon fermeture à clé Ø 65 mm	Iveco Daily dep 2003, Mago dep 2003	

RÉF ATS	DÉSIGNATION	PARTICULARITÉS	
<b>76391</b>	Bouchon	Irisbus Magelys HD, Pro	

RÉF ATS	DÉSIGNATION	PARTICULARITÉS	
<b>78252</b>	Bouchon gasoil livré sans barillet Ø 80 mm	Irisbus Recreo Euro 5, Crossway	

RÉF ATS	DÉSIGNATION	PARTICULARITÉS	
<b>35482</b>	Bouchon plastique sans clé Ø int 80 mm - Ø ext 155 mm	Iveco Eurorider, Euroclass, Man, Setra série 200	

## Evobus

RÉF ATS	DÉSIGNATION	PARTICULARITÉS	
<b>41758</b>	Bouchon plastique sans clé Ø int 58 mm	Evobus 0350, 0404	

## Man, Fast

RÉF ATS	DÉSIGNATION	PARTICULARITÉS	
<b>73447</b>	Bouchon Ø 80mm	Fast Scoler A91, Fast Syter A51, Tourliner, Man Lion's Coach, R07, R08, R09, Starliner, Lion's Regio A72	

RÉF ATS	DÉSIGNATION	PARTICULARITÉS	
<b>35343</b>	Bouchon métallique fermeture à clé Ø int 80 mm - Ø ext 115 mm	Man, Mercedes, Volvo	

## Otokar

RÉF ATS	DÉSIGNATION	PARTICULARITÉS	
<b>87370</b>	Bouchon réservoir	Otokar Navigo 240S	NR
<b>92918</b>	Bouchon réservoir	Otokar Vectio	

## Scania

RÉF ATS	DÉSIGNATION	PARTICULARITÉS	
<b>35465</b>	Bouchon métallique Ø int 65 mm - Ø ext 85 mm	Scania jsq 1998, Volvo	

RÉF ATS	DÉSIGNATION	PARTICULARITÉS	
<b>92150</b>	Bouchon réservoir acier Ø 55 mm	Scania série 4 L94, série F/K/N, CK/UB	

## Vanhool

RÉF ATS	DÉSIGNATION	PARTICULARITÉS	
<b>47638</b>	Bouchon fermeture à clé Ø 80 mm	Vanhool T8, T9	

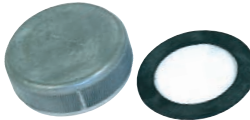
RÉF ATS	DÉSIGNATION	PARTICULARITÉS	
<b>40076</b>	Bouchon - Ø 80 mm	Vanhool T8, T9	
<b>40455</b>	Joint caoutchouc		

RÉF ATS	DÉSIGNATION	PARTICULARITÉS	
<b>54317</b>	Bouchon à clapet	Vanhool T9	

## VDL

RÉF ATS	DÉSIGNATION	PARTICULARITÉS	
<b>84566</b>	Bouchon réservoir	VDL Bova Magiq	



### BMC



RÉF ATS	DÉSIGNATION	APPLICATION	
<b>80551</b>	Jauge à gasoil	BMC Probus	
<b>80166</b>		BMC Midilux	

### Evobus

RÉF ATS	DÉSIGNATION	RÉF CONSTRUCTEUR	APPLICATION		
<b>35791</b>	Jauge à gasoil	<b>87439810000</b>	Evobus		
<b>3818</b>		<b>8743502000</b>	Setra 313-315UL Euro 2, 3		NR
<b>84421</b>		<b>A0135427117</b>	0510 Tourino		NR

### Iveco, Irisbus

RÉF ATS	DÉSIGNATION	RÉF CONSTRUCTEUR	APPLICATION	
<b>54131</b>	Jauge à gasoil	<b>5001839568</b>		
<b>56292</b>		<b>5001839570</b>	Irisbus Recreo, Axer Euro 2, 3	
<b>66565</b>		<b>504055613</b> 2 tuyaux	Iveco Daily 35C9, 10, 11, 12, 14, 15 50C11, 12, 13, 14, 15, 17 65C13, 14, 15, 17	
<b>95237</b>		<b>504055614</b> 3 tuyaux		
<b>72057</b>		<b>504118565</b>	Crossway, Recreo New, Evadys H, Arway Euro 4	NR

RÉF ATS	DÉSIGNATION	RÉF CONSTRUCTEUR	APPLICATION	
<b>61248</b>	Réservoir droit côté remplissage Livré avec jauge	<b>5006024186</b>	Irisbus Recreo, Axer Euro 3	
<b>62741</b>	Réservoir gauche	<b>5006024187</b>		
<b>49900</b>	Réservoir 310 L	<b>5006156083</b>	Irisbus Ares	



### Otokar

RÉF ATS	DÉSIGNATION	APPLICATION	
<b>88965</b>	Jauge à gasoil	Otokar Vectio 250T, 250S, 290T, 250U	NR
<b>87677</b>	Jauge à gasoil	Otokar Navigo 165, 185 S, 185 SH, 185 SE	

## Ø 69

RÉF ATS	DÉSIGNATION	PARTICULARITÉS	
<b>53822</b>	Réservoir en fer (bouchon à clapet) Récupération bouchon d'origine	Iliade, FR1, Agora, GX317, 117	

## Ø 105

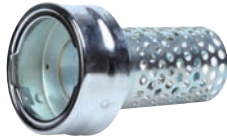
RÉF ATS	DÉSIGNATION	PARTICULARITÉS	
<b>58259</b>	Goulotte et crépine basse 2 ergots, H 130	Bova	
<b>53824</b>	Goulotte et crépine basse (bouchon sans clapet)	Mercedes, Volvo, Man, Renault, DAF, Iveco, Tracer dep 1994	
<b>51538</b>	Goulotte et crépine basse (bouchon avec clapet)	Mercedes, Volvo, Man, Renault, DAF, Iveco, Tracer dep 1994	

## Ø 60, 63, 72

RÉF ATS	DÉSIGNATION	PARTICULARITÉS	
<b>53823</b>	À bague - Réservoir plastique Récupération bouchon d'origine	GX327,57,217, GX107,117,317, Volvo, Scania, Iliade, Ares, Axer, Recreo, Mascott	

## Ø 72

RÉF ATS	DÉSIGNATION	PARTICULARITÉS	
<b>60092</b>	À bague - Réservoir fer	Recreo	



## Ø 70

RÉF ATS	DÉSIGNATION	PARTICULARITÉS	
<b>60093</b>	Pour réservoir plastique	Irisbus Axer, Ares, Recreo, Iliade, Fr, Agora Articule, Heuliez GX57, GX107, GX117, GX127	

## Ø 60

RÉF ATS	DÉSIGNATION	PARTICULARITÉS	
<b>58260</b>	À visser - Ø 60 Avec récupération du bouchon d'origine	Scania, Iveco	





### Iveco/Irisbus

RÉF ATS	DÉSIGNATION	RÉF ORIGINE	PARTICULARITÉS	
<b>54936</b>	Sonde de pression d'huile Irisbus 0-10 bars M 14 X 1,5		Moteur RVI 0622045 Recréo Euro 2	
<b>65183</b>	Mano contact d'huile Recreo, Axer, Citelis, Heuliez GX327, 427	<b>98445111</b> <b>98442879</b>	Moteur Cursor	
<b>72934</b>	Sonde de pression d'huile Arway Euro 4, Citelis Line, Crossway, Recreo, Domino HD, HDH, Magelys HD, HDH	<b>500351609</b>	Moteur F2B Cursor 8,10	
<b>Plus livrable</b>	Transmetteur de pression Iliade, Ares	<b>5010311242</b>	MIDR 0622045	
<b>72943</b>	Mano contact huile Iliade, Ares	<b>5010398062</b>	MIDR 0622045 0,6 bars	

### Man

RÉF ATS	DÉSIGNATION	RÉF ORIGINE	PARTICULARITÉS	
<b>50100</b>	Sonde de pression d'huile Moteur Man 0-5 bars 0,25 + 0,15 bars		D2866LUH20, 21 D2866LOH20, 21, 22 - D2876LF02	

### Mercedes

RÉF ATS	DÉSIGNATION	RÉF ORIGINE	PARTICULARITÉS	
<b>34315</b>	Sonde de pression d'huile Moteur Mercedes M 18 X 1,5 - Moteur Euro 0, 1 0-5 bars - 0,25 + 0,15 bars		OM401A/LA - OM402A/LA OM441A/LA - OM427H/HA OM442A/LA - OM447H/LA/HLA	
<b>47592</b>	Sonde de pression d'huile Moteur Mercedes M 18 X 1,5 - Moteur Euro 2 0-5 bars - 1 fiche		OM442A/LA OM441A/LA	
<b>38394</b>	Sonde de pression d'huile Moteur Mercedes 0-10 bars 5,5 bars + 0,5-0,1 M 14 X 1,5 - 3 fiches		0350 Euro 2 0345 Euro 2	
<b>71087</b>	Sonde de pression d'huile M 16 X 1,5	<b>0001539932</b>	OM904LA - OM906HLA OM926LA - OM936 OM501LA - OM502LA	

### Scania

RÉF ATS	DÉSIGNATION	RÉF ORIGINE	PARTICULARITÉS	
<b>72932</b>	Sonde de pression d'huile Scania série 4	<b>374338</b>	M14 X 1,5 - Pression commutation 0-10 bars écart de réglage 0,7+/- 0,15 bars	





## Fast

RÉF ATS	DÉSIGNATION	PARTICULARITÉS	
<b>66249</b>	Support moteur avant Fast Scoler 1, 2	Moteur Renault 062226W Euro 1, 2	
<b>66230</b>	Support moteur Fast Scoler 1, 2	Euro 2 2 par véhicule	



## Man, Neoplan, Fast, Temsa

RÉF ATS	DÉSIGNATION	PARTICULARITÉS	
<b>72926</b>	Support boîte de vitesse Fast Scoler 4 Euro 4, 5 - Man Lion'S City A20, A21, A23, Man Lion'S Regio R12, 13, 14, Trendliner P23, P24, P25	D2066LUH, D2866LUH	
<b>36238</b>	Support moteur Fast Syter châssis Man A01, A10, A11, A15, A18 - 23, A29, A61, A69, A72, A75 Man Pionner SU 263, 283, 313	D0836, D2866	
<b>72927</b>	Support moteur Temsa Safari, Man Lion'S Coach R07, 08, 09, Skyliner PB1, PB2 N1122/3	D2066LOH, D2876LOH Euro 4 Application boîte de vitesse AS Tronic et GO Mercedes	
<b>94683</b>	Palier moteur Lion's star, Lion's coach R07, R08, Starliner, Tourliner,	Moteur D2866 LOH 27-29/32-35-40/50 D2066LOH Euro 4, 5, 6 - D2066LOH Euro 4, 5	
<b>94684</b>	Palier moteur Lion's coach R07, R08, R09 Tourliner, Cityliner, Skyliner, Starliner	Moteur D2066 LOH Euro 4, 5, 6 D2676 LOH Euro 5, 6	
<b>94685</b>	Palier moteur arrière Lion's coach R07, R08, R09 Cityliner, Skyliner, Starliner, Tourliner	Moteur D2066 LOH Euro 4, 5, 6 D2676 LOH Euro 5, 6	
<b>94686</b>	Palier moteur avant Startliner, Tourliner, Lion's Star, Lion's Coach R07, R08	Moteur D2866 LOH D2876 LOH	









## Iveco/Irisbus

RÉF ATS	DÉSIGNATION	RÉF ADAPTABLE	PARTICULARITÉS	
<b>77734</b>	Silentbloc Irisbus Recreo Axer Euro 3, Recreo Euro 2, Ares Moteur Cursor, Anways, Evadys	<b>5801104136</b>	Boîte Zf 6S1600 Moteur Cursor	
<b>55384</b>	Support moteur arrière Irisbus Agora, Citelis, GX327, GX427, Crealis (côté turbo)	<b>504163411</b>	Moteur Cursor F2BE	
<b>67058</b>	Support moteur arrière Irisbus Agora, Citelis, GX327, GX427, Crealis	<b>504163413</b>	Moteur Cursor F2BE	
<b>67057</b>	Support Moteur Citelis GX327 (2 par véhicule)	<b>504177837</b>	Moteur Cursor 8 F2B0682	

### Iveco/Irisbus

RÉF ATS	DÉSIGNATION	RÉF ADAPTABLE	PARTICULARITÉS	
<b>93994</b>	Support moteur avant Recreo, Crossway, Arway Crossway LE Euro 6, Evadys H Magelys Euro 6	<b>504139781</b>	Moteur Cursor 8,9 Euro 4, 5, 6	
<b>84844</b>	Tasseau de suspension arrière Recreo, Crossway, Arway Crossway LE Euro 6, Evadys H Magelys Euro 6	<b>504139780</b>	Moteur Cursor 8,9 Euro 4, 5, 6	
<b>94235</b>	Support moteur avant Crossway, Recreo Crossway LE CC130E24 CC150E25 Euro 4, 5, 6 Eurorider 27	<b>504087860</b>	Moteur Tector	



### Mercedes

RÉF ATS	DÉSIGNATION	RÉF ADAPTABLE	PARTICULARITÉS	
<b>63832</b>	Silentbloc moteur Mercedes Setra S411-416UJ, GT, GTHD 0580 Travego, 0350 Euro 3	<b>6292400217</b>	Avant moteur OM457LA, OM457HLA, OM501LA	
<b>63833</b>	Silentbloc moteur Mercedes 0530 Euro 2, 0345 Euro 3	<b>6282401717</b>	OM906LA, OM457HLA	
<b>63834</b>	Silentbloc moteur Mercedes 0530 Citaro Sur palier AR	<b>6282401817</b>	Moteur OM457HLA Euro 3, 4	
<b>63835</b>	Silentbloc moteur Mercedes Setra 415, 416, 417, HD, HDH Setra 431DT, Travego 0580	<b>9402401318</b>	Moteur OM502LA	
<b>94241</b>	Support moteur Arrière gauche et droit Intouro	<b>6282403217</b>	Moteur 926LA	
<b>93895</b>	Support moteur Gauche et droit Intouro	<b>9732400318</b>	Moteur 926LA	
<b>64156</b>	Silentbloc moteur Mercedes Connecto 0345 Euro 3	<b>9412417513</b>	OM457HLA L 230 - Ep 130	
<b>64157</b>	Silentbloc moteur Mercedes Connecto 0345 Euro 3	<b>9412417613</b>	OM457HLA L 230 - Ep 130	





## Neoplan, Mercedes

RÉF ATS	DÉSIGNATION	RÉF ADAPTABLE	PARTICULARITÉS	
<b>42651F</b>	Support moteur Neoplan, Transliner, Cityliner dep 06/94 Evobus Mercedes 0303, 0330, 0340, 0345, 0350, 0404, 0405, 0408 Evobus Setra série 200, 300	<b>3572400618</b>	OM442LA, D2866LOH	

## Scania

RÉF ATS	DÉSIGNATION	RÉF ADAPTABLE	PARTICULARITÉS	
<b>45810</b>	Support moteur inferieur Scania série 3		Ø Extérieur 100 mm Épaisseur / Force 57 mm	
<b>51375</b>	Support boîte de vitesse Scania Irizar série 4	<b>1336882</b>	Moteur DSC12.01 - DSC12.02 - DC12.01 - DC11.02 - DT12.08 - DC11.04 L 285 mm - l 168 mm - H 175 mm	

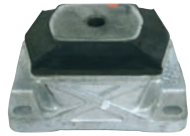
## Vanhool

RÉF ATS	DÉSIGNATION	PARTICULARITÉS	
<b>68160</b>	Support boîte de vitesse Vanhool T9 Euro 4	Boîte de vitesse G0 Mercedes	
<b>54987</b>	Support moteur avant gauche	Vanhool, Man châssis A08, A15, A18, A20	
<b>48768</b>	Support moteur avant droit		
<b>39781</b>	Support moteur	Vanhool L 180 - L 104 mm	
<b>35219</b>	Support moteur	Vanhool H 72 mm - Ø 99 mm	

## Volvo

RÉF ATS	DÉSIGNATION	RÉF ADAPTABLE	PARTICULARITÉS	
<b>64162</b>	Support moteur Volvo B12M	<b>1629614</b>	Arrière	

### Durite d'eau droite 1 M bleue

RÉF ATS	DIMENSION
4964	D = 6
4965	D = 8
4966	D = 10
4967	D = 12
4968	D = 14
4969	D = 15
4970	D = 16
4987	D = 18
4972	D = 20
4973	D = 22

RÉF ATS	DIMENSION
4974	D = 25
4975	D = 28
4976	D = 30
4977	D = 32
4978	D = 35
4979	D = 38
4980	D = 40
4981	D = 42
4982	D = 45
38765	D = 48

RÉF ATS	DIMENSION
4983	D = 50
4984	D = 55
4985	D = 60
34201	D = 65
4986	D = 70
4988	D = 80
4989	D = 90
4990	D = 100



### Durite d'eau droite 1 M renforcée rouge

RÉF ATS	DIMENSION
85159	D = 8
85135	D = 10
85136	D = 12
85138	D = 14
90727	D = 16
85139	D = 18
85122	D = 20
85141	D = 22

RÉF ATS	DIMENSION
85142	D = 25
85143	D = 28
85144	D = 30
85145	D = 32
85146	D = 35
85147	D = 38
85148	D = 40
85152	D = 42

RÉF ATS	DIMENSION
85153	D = 45
90728	D = 48
85134	D = 50
85154	D = 55
85155	D = 60
85157	D = 70



ENVIRONNEMENT  
MOTEUR

### Réduction

RÉF ATS	DIMENSION
35235	18 X 13
34433	19 X 16
35237	22 X 19
35238	28 X 22
35239	28 X 25
35241	32 X 25
35242	32 X 28
35243	35 X 25
35244	35 X 28

RÉF ATS	DIMENSION
35245	35 X 32
38298	38 X 19
35246	38 X 22
35247	38 X 25
34434	38 X 28
35231	38 X 32
35232	40 X 35
38346	45 X 32
34432	45 X 38

RÉF ATS	DIMENSION
40656	50 X 45
34431	51 X 38
36082	51 X 45
36926	54 X 51
34241	60 X 50
36320	70 X 50
34202	70 X 60
48243	70 X 65



## Durite d'eau coudée à 90°

RÉF ATS	DIMENSION
<b>4943</b>	D = 10
<b>37724</b>	D = 14
<b>36503</b>	D = 15
<b>34484</b>	D = 16
<b>34199</b>	D = 18
<b>34203</b>	D = 20
<b>34204</b>	D = 22
<b>4942</b>	D = 25
<b>34194</b>	D = 28
<b>34205</b>	D = 30
<b>37299</b>	D = 32
<b>5015</b>	D = 35
<b>34281</b>	D = 38

RÉF ATS	DIMENSION
<b>34206</b>	D = 40
<b>38046</b>	D = 45
<b>47864</b>	D = 48
<b>34372</b>	D = 50
<b>41409</b>	D = 55
<b>34453</b>	D = 60
<b>39601</b>	D = 63
<b>37725</b>	D = 65
<b>38361</b>	D = 70
<b>43013</b>	D = 75
<b>41628</b>	D = 80
<b>37609</b>	D = 90



## Durite d'eau coudée à 45°

RÉF ATS	DIMENSION	
<b>52241</b>	D = 18	L = 100
<b>53086</b>	D = 20	L = 100
<b>52242</b>	D = 22	L = 100
<b>52240</b>	D = 25	L = 100
<b>51315</b>	D = 28	L = 100
<b>52243</b>	D = 30	L = 150
<b>63052</b>	D = 32	L = 100
<b>52246</b>	D = 35	L = 150
<b>34195</b>	D = 40	L = 100
<b>52245</b>	D = 41	L = 100

RÉF ATS	DIMENSION	
<b>35667</b>	D = 45	L = 100
<b>34207</b>	D = 48	L = 100
<b>43518</b>	D = 50	L = 100
<b>48242</b>	D = 50	L = 150
<b>52975</b>	D = 55	L = 100
<b>52995</b>	D = 60	L = 100
<b>39499</b>	D = 63	L = 100
<b>42410</b>	D = 63	L = 200
<b>51525</b>	D = 70	L = 100
<b>42828</b>	D = 90	L = 100



## Colliers Inox

RÉF ATS	POUR DIAMÈTRE MIN D1	POUR DIAMÈTRE MIN D2
<b>93647</b>	17	32
<b>84182N</b>	21	38
<b>84179N</b>	21	44
<b>84180N</b>	27	51
<b>93651</b>	33	57
<b>84187N</b>	40	64
<b>84185N</b>	46	70



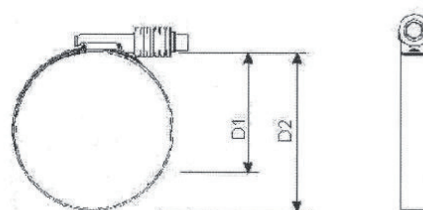







RÉF ATS	POUR DIAMÈTRE MIN D1	POUR DIAMÈTRE MIN D2
<b>71512N</b>	52	76
<b>63581N</b>	59	83
<b>62519</b>	70	92
<b>54396</b>	95	118
<b>61842</b>	100	120
<b>54397</b>	108	130





### Evobus

RÉF ATS	DÉSIGNATION	CORRESPONDANCE	APPLICATION	
<b>34241</b>	Réduction 60/50 mm	<b>A0015015082</b>	Connecto, Citaro, Intouro, Travego	
<b>34372</b>	Coude 90° - 50 mm	<b>A0009872237</b>	Citaro, Intouro, Tourino, Travego Setra série 400	
<b>94086</b>	Réduction 65/50 mm	<b>A0015013782</b>	Citaro, Turismo, Travego, Setra série 400	
<b>94085</b>	Coude 90° - 60 mm	<b>A6285014482</b>	Citaro, Connecto, Turismo, Travego, Setra série 400	
<b>94084</b>	Coude réduit 90°	<b>A0015013982</b> <b>A0025012082</b>	Citaro, Turismo, Travego	
<b>34202</b>	Réduction 70/60 mm	<b>A008321894</b>	Setra série 400 UL, GTHD, H, HD, HDH Citaro 431DT	
<b>94087</b>	Coude 90° - 60 mm	<b>A6285010782</b>	Citaro, Connecto, Travego, S412 - 416UL, Integro New	
<b>93992</b>	Durite réduit Coudée - 60/55 mm	<b>A0009873637</b>	Citaro Low Entry Setra 412-417UL, Integro New	
<b>94088</b>	Durite coudée 45° - Réduction - 65/60m	<b>A0015012382</b>	Setra 412-417UL, S415-417HDH, S415-417 GTHD Integro New, Turismo New	
<b>94103</b>	Durite Eau 60 X 72 X 100 mm	<b>N000000005008</b>	411HD, 431DT Travego, Citaro, 0350 Turismo	
<b>94104</b>	Durite double coude	<b>A6285010982</b>	Citaro, Connecto OM457	



## Iveco/Irisbus

RÉF ATS	DÉSIGNATION	CORRESPONDANCE	APPLICATION	
<b>94797</b>	Durite sur moteur 90° - 50 X 60	<b>504118735</b>	Crossway LE, Arway, Recreo New	
<b>63161</b>	Durite eau Boîte de vitesse	<b>5006152932</b>	Agora, Citelis	
<b>71214</b>	Durite coudée Ø 38 mm	<b>504118248</b>	Arway Euro 3, 4, 6, Citelis, Citelis Line, Recreo Euro 4, 5 Crealis, Crossway Euro 4, 5, 6, Crossway LE Euro 6, Evadys Euro 4, Magelys HD0	
<b>81362</b>	Durite coudée Ø 60 mm	<b>504289483</b>	Arway, Evadys HD, Magelys HD, HDH, Pro	
<b>81477</b>	Durite coudée Ø 50 mm	<b>504118264</b>	Arway Euro 4, Recreo Euro 4, 5 Crossway, Crossway LE Euro 4, 5	
<b>81466</b>	Durite coudée Radiateur	<b>5006154840</b>	Agora, Citelis	
<b>78631</b>	Durite coudée Eau boîte de vitesse	<b>5801693268</b>	Citelis, Créalis GX327/427	
<b>55980</b>	Durite sortie Radiateur eau - Ø 60 mm	<b>5010503002</b>	Ares, Iliade Euro 3	
<b>81485</b>	Durite coudée 90°	<b>5006154837</b>	Agora, Citelis	
<b>63173</b>	Réduction 38-20 mm Chauffage	<b>504118281</b>	R312 Citelis, Iliade, Ares, Agora Arway Euro 3, 4, Evadys Recreo Euro 4, 5, GX127 Euro 4	
<b>39185</b>	Durite coudée Ø 38 mm sur boîte automatique	<b>5010009912</b>	Tracer, Ares, Arway, Evadys	

### Iveco/Irisbus

RÉF ATS	DÉSIGNATION	CORRESPONDANCE	APPLICATION	
<b>85164</b>	Durite eau Boîte de vitesse	<b>500300763</b>	Citelis, Cityclass, Urbanway Eurorider 27/31/35 GX327/427/437	
RÉF ATS	DÉSIGNATION	CORRESPONDANCE	APPLICATION	
<b>94796</b>	Durite sur pompe à eau 45° - 50 X 60	<b>504241387</b>	Crossway LE, Evadys H Euro 4, Arway, Crossway, Recreo New	

### Man

RÉF ATS	DÉSIGNATION	CORRESPONDANCE	APPLICATION	
<b>94543</b>	Durite d'eau Int Ø 21 Ex Ø 32	<b>81963050125</b>	SL/SG/SÜ NL/NG/ND/NM EL/ÜL/RH Lion's (City, Classic) ManSue Fast Syter A51 Fast Scoler A91	
RÉF ATS	DÉSIGNATION	CORRESPONDANCE	APPLICATION	
<b>76635</b>	Durite d'eau Int Ø 37 Ex Ø 47	<b>81963010387</b>	SL/SG/SÜ NL/NG/ND/NM EL/ÜL/RH Lion's coach R07, R08, R09 Centroliner, Cityliner, Starliner, Tourliner, Trendliner	
RÉF ATS	DÉSIGNATION	CORRESPONDANCE	APPLICATION	
<b>94547</b>	Durite d'eau Ø 60 H 85	<b>81963050134</b>	SL/SG/SÜ NL/NG/ND ÜL/RH Lion's Centroliner, Starliner, Tourliner	
RÉF ATS	DÉSIGNATION	CORRESPONDANCE	APPLICATION	
<b>94548</b>	Durite d'eau Coudée 36° 60/60-43/60/43 Ø 60 H 85	<b>81.963050382</b>	SL/SÜ NL Lion's coach R07, R08, R09 Lion's Regio R11, R13, R14 Centroliner, Cityliner, Skyliner, Starliner, Tourliner, Trendliner	
RÉF ATS	DÉSIGNATION	CORRESPONDANCE	APPLICATION	
<b>94550</b>	Durite d'eau Int Ø 60 H 235	<b>81963050383</b>	SL/SÜ NL Lion's coach R07, R08, R09 Lion's Regio R11, R13, R14 Cityliner, Skyliner, Starliner, Tourliner, Trendliner	

## Man, Neoplan

RÉF ATS	DÉSIGNATION	CORRESPONDANCE	APPLICATION	
<b>94551</b>	Durite d'eau soudée 50/50 - 40/100/40	<b>81963010389</b>	SG NL/NG/NÜ/ND/NM ÜL/RH Lion's City Lion's coach R07 R08 R09 Centroliner, Tourliner	
<b>94552</b>	Durite d'eau	<b>81963010639</b>	SR NL Lion's City Centroliner	
<b>94553</b>	Durite d'eau 60/60-40/40/75	<b>81963050207</b>	NL/NG/NÜ Lion's Lion's coach R07 R08 R09 Lion's regio Centroliner, Tourliner	

## Scania

RÉF ATS	DÉSIGNATION	CORRESPONDANCE	APPLICATION	
<b>94473</b>	Durite d'eau L 34 - Ø 30	<b>483182</b>	Série 4, K/L 94, K114, K124, Irizar Century	
<b>94475</b>	Durite d'eau L 33 - Ø 30,5 - H 410	<b>1426194</b>	Série 4, F114, F-/K-/N-séries F	
<b>94477</b>	Durite d'eau Int Ø 31 - Ext Ø 42 - L 81	<b>1376295</b>	Série 4, F94, F114 F-/K-/N-séries F	
<b>94478</b>	Durite d'eau L 152 - Ø 31,75	<b>481937</b>	Série 4, K/L 94, K114, K124 F-/K-/N-séries K/N, Irizar Century	
<b>94480</b>	Durite d'eau Int Ø 32 - Ext Ø 41 - L 110	<b>290864</b>	Série 4, F/K/L/N 94, F114 F-/K-/N-séries K	
<b>94481</b>	Durite d'eau L 60 - Ø 42	<b>413398</b>	Série 4, K/L/N 94 F-/K-/N-séries F/K/N, Moteur DC9, OC9	

### Scania

RÉF ATS	DÉSIGNATION	CORRESPONDANCE	APPLICATION	
<b>94483</b>	Durite d'eau Ø 48 - Ø 55	<b>481886</b>	Série 4, K/L 94, K114, K124, Irizar Century	
<b>94484</b>	Durite d'eau Ø 55	<b>1523338</b>	Série 4, K/L 94, K114, K124, Irizar Century	
<b>94486</b>	Durite d'eau Ø 55 - Ø 049 - H 495	<b>485995</b>	Série 4, K/L 94, CL 94 UA/UB, Omnicity	
<b>94488</b>	Durite d'eau Ø 55 - H 120	<b>297394</b>	Série 4, N 94, CN 94 UA/UB, Omnicity	
<b>94490</b>	Durite d'eau Ø 55	<b>1446379</b>	F-/K-/N-séries F	
<b>94492</b>	Durite d'eau Ø 55	<b>481885</b>	Série 4, K/L 94, K114, K124	
<b>94494</b>	Durite d'eau Ø 55	<b>485926</b>	Série 4, K114, K124	
<b>94496</b>	Durite d'eau L 34 - Ø 55	<b>1373919</b>	Série 4, F 94	
<b>94497</b>	Durite d'eau Ø 56	<b>1872597</b>	Série 4, F/K/L/N 94, K114, K124, CL 94 UA/UB, F-/K-/N-séries K/N, Omnicity /Irizar Century, Moteur DC-OC 9, DC 11, DC-DT 12	
<b>94499</b>	Durite d'eau Ø 56	<b>1755953</b>	F-/K-/N-séries F	
<b>94501</b>	Bouchon pour tuyau d'eau de refroidissement	<b>1530394</b>	Série 4, F/K/L 94, CL 94, CN 94	

## Volvo

<b>RÉF ATS</b> <b>94502</b>	DÉSIGNATION Durite d'eau	<b>CORRESPONDANCE</b> <b>9519306</b>	APPLICATION B 9 L, B 12 /R, B 13 R Volvo 9700/9900	
<b>RÉF ATS</b> <b>94503</b>	DÉSIGNATION Durite d'eau	<b>CORRESPONDANCE</b> <b>21442026</b>	APPLICATION B 9 L/R/S/ TL, B 12 B/M B 13 R, Volvo 9700/9900	
<b>RÉF ATS</b> <b>94504</b>	DÉSIGNATION Durite d'eau	<b>CORRESPONDANCE</b> <b>21461832</b>	APPLICATION B 9 L/R/S/ TL, B 12 B/M B 13 R, Volvo 9700/9900	
<b>RÉF ATS</b> <b>94506</b>	DÉSIGNATION Durite d'eau	<b>CORRESPONDANCE</b> <b>1136333</b>	APPLICATION B 9 L/R/S/ TL, B 12 B/M/R B 13 R, Volvo 9700/9900	
<b>RÉF ATS</b> <b>94507</b>	DÉSIGNATION Durite d'eau Int Ø 60 - Ext Ø 90	<b>CORRESPONDANCE</b> <b>3031068</b>	APPLICATION B 9 L/R/S, B 12 B/M, B 13 R, Volvo 9700/9900	
<b>RÉF ATS</b> <b>94513</b>	DÉSIGNATION Durite d'eau	<b>CORRESPONDANCE</b> <b>1195081</b>	APPLICATION B 9 L/S, B 12 B/M/R	
<b>RÉF ATS</b> <b>94515</b>	DÉSIGNATION Durite d'eau	<b>CORRESPONDANCE</b> <b>21461821</b>	APPLICATION B 9 L/S, B 12 B, B 13 R, Volvo 9700/9900	
<b>RÉF ATS</b> <b>94517</b>	DÉSIGNATION Durite d'eau Int Ø 50 - Ext Ø 60 - H 160	<b>CORRESPONDANCE</b> <b>1196391</b>	APPLICATION B 9 R/S, B 12 B/M, B 10 M, B 7 R	
<b>RÉF ATS</b> <b>94519</b>	DÉSIGNATION Durite d'eau Int Ø 48 - Ext Ø 57 - L 312	<b>CORRESPONDANCE</b> <b>9517020</b>	APPLICATION B 9 R/S/ TL, B 12 B/M, B 7 L/R, B 10 M/L Volvo 7700/9500	
<b>RÉF ATS</b> <b>94520</b>	DÉSIGNATION Durite d'eau Int Ø 48 - Ext Ø 57 - L 228	<b>CORRESPONDANCE</b> <b>9516935</b>	APPLICATION B 9 R/ TL, R 7 R/L, B 10 M/R	
<b>RÉF ATS</b> <b>94522</b>	DÉSIGNATION Durite d'eau Int Ø 33,5 - Ext Ø 43,5 - L 71	<b>CORRESPONDANCE</b> <b>469951</b>	APPLICATION B 9 S/ TL, B 12 B/M, B 13 R, B 10 M	

### Volvo

RÉF ATS	DÉSIGNATION	CORRESPONDANCE	APPLICATION	
<b>94524</b>	Durite d'eau Int Ø 58 - Ext Ø 68	<b>1195576</b>	B 9 S, B 12 B/M/R, B 13 R, Volvo 9700/9900	
<b>94526</b>	Durite d'eau	<b>21461815</b>	B 9 S, B 12 B/M, Volvo 8700	
<b>94528</b>	Durite d'eau Int Ø 30 - Ext Ø 30 - L 103	<b>3030439</b>	B 9 TL, B 10 B, B 10 M, B 7 R, B 12	
<b>94530</b>	Durite d'eau Ø 60 X 100/100/200	<b>9519701</b>	B 12	
<b>94533</b>	Durite d'eau	<b>3031477</b>	B 12	
<b>94534</b>	Durite d'eau	<b>3028329</b>	B 12 B/M	

### DURITES DE TURBO ET ÉCHANGEURS

### Evobus

RÉF ATS	DÉSIGNATION	APPLICATION	
<b>79440</b>	Durite d'intercooler L 190 mm - Ø 100 mm	S313-315UL, 0550 Euro 3, Citaro Low Entry, S415-417HDH, S412-419UL, S415-416H, Integro New Moteur OM457LA, HLA	
<b>79443</b>	Durite entrée intercooler L 200 mm - Ø 85 mm	Intouro, Citaro, Tourino Moteur OM926LA, 906HLA	
<b>79441</b>	Durite entrée air moteur L 160 mm - Ø 115 mm	S431DT, Travego 17SHD, Travego 15RHD, S415-417HDH Moteur OM502LA	
<b>79439</b>	Durite entrée air moteur L 150 mm - Ø 100 mm	Setra 415-419UL, 415-416H/GT, Citaro Low Entry, Integro New Moteur OM457HLA	

## Evobus

RÉF ATS	DÉSIGNATION	APPLICATION	
<b>79445</b>	Durite entrée radiateur intercooler L 130 mm - Ø int 100 - Ø ext 115	Travego 15, 16, 17 RHD, S415-417 GTHD, HDH, Tourismo New 15, 16, 17 RHD Moteur OM457LA	
<b>79444</b>	Durite intercooler L 200 mm - Ø int 85 mm	Citaro N3, GN3, GNU3 Euro 3, Citaro K Euro 4 Moteur OM906LA, 906 HLA	
<b>81582</b>	Durite entrée filtre à air	0405, 0345 Euro 2 Moteur OM447HLA	
<b>61545</b>	Durite d'échangeur L 240 - Ø 100	0345 Connecto, 0405, 0408 Moteur OM457HLA, OM447HLA	
<b>69903</b>	Durite d'échangeur L 200 - Ø 100	0350 Tourismo, 0530 Citaro, 0345 Connecto Moteur OM457HLA	
<b>72983</b>	Durite d'échangeur L 100 - Ø 100	0345 Connecto, 0530 Citaro Moteur OM457HLA, OM906LA	
<b>72984</b>	Durite d'échangeur L 210 - Ø 115	Setra S415-417 HDH Moteur OM502LA	
<b>94372</b>	Durite d'échangeur Ø 116	Setra 415-417 HDH, Setra 416 - 419 GTHD, S431DT Moteur OM502LA	

## Iveco/Irisbus

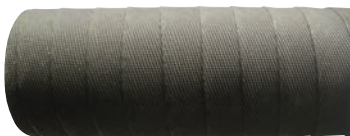
RÉF ATS	DÉSIGNATION	APPLICATION	
<b>66218</b>	Durite de turbo côté filtre à air	Recreo Euro 3, Axer Euro 3	
<b>72886</b>	Durite échangeur d'air (2 par véhicules)	Recreo Euro 3, Axer Euro 3	









### Iveco/Irisbus

<b>RÉF ATS</b>	DÉSIGNATION	APPLICATION	
<b>66217</b>	Durite échangeur d'air coudée supérieure sur turbo	Recreo Euro 3, Axer Euro 3	
<b>RÉF ATS</b>	DÉSIGNATION	APPLICATION	
<b>66219</b>	Durite échangeur d'air coudée inférieure (noir)	Recreo Euro 3, Axer Euro 3, Arway Euro 3, Ares Euro 3 moteur Cursor, Evadys Euro 3	
<b>RÉF ATS</b>	DÉSIGNATION	APPLICATION	
<b>55980</b>	Durite inférieure sur échangeur d'air	Iliade Euro 3 moteur DCI, Ares Euro 3 moteur DCI	
<b>RÉF ATS</b>	DÉSIGNATION	APPLICATION	
<b>72885</b>	Durite sur turbo côté filtre à air	Arway Euro 3, Ares Euro 3 moteur Cursor, Evadys Euro 3	
<b>RÉF ATS</b>	DÉSIGNATION	APPLICATION	
<b>70227</b>	Durite de turbo côté filtre à air	Recreo Euro 4, Crossway Euro 4 moteur Cursor	
<b>RÉF ATS</b>	DÉSIGNATION	APPLICATION	
<b>69088</b>	Durite entre turbo et échangeur d'air	Arway Euro 4, Crossway, Recreo, Evadys H Euro 4 - 10 x 22 mm	
<b>RÉF ATS</b>	DÉSIGNATION	APPLICATION	
<b>81374</b>	Durite coudée	Agora 5010423445	
<b>RÉF ATS</b>	DÉSIGNATION	APPLICATION	NR
<b>81994</b>	Durite multispire sur radiateur 2 par véhicule	Recreo Euro 4, 5, Crossway Euro 4, 5, Arway Euro 4, Crossway LE Euro 5, Moteur Cursor 8	

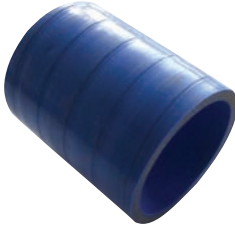
### Man, Fast, Neoplan

<b>RÉF ATS</b>	DÉSIGNATION	APPLICATION	
<b>72985</b>	Durite d'échangeur L 160 - Ø 90	Man Lion's City A21 NL223/263/316F Lion's Coach R07, R08, Lion's Regio R12, R13, R14 Neoplan Starliner N52185HD, P12, Trendliner N3516, P23, P24, Tourliner P21, P22, Centroliner N4521 Moteur D2866LOH, D2876LOH, D2866LUH Euro 3	

## Man, Fast, Neoplan

<b>RÉF ATS</b> <b>72986</b>	DÉSIGNATION Durite d'échangeur L 130 - Ø 90	APPLICATION Fast Scoler A91, Man SUE A72, Lion's City A21 NL 223/263/313, Man A91 Moteur D2866LUH, D0836LUH 40/41/50, D0836LUH01/08, D2066LUH	
<b>RÉF ATS</b> <b>72987</b>	DÉSIGNATION Durite d'échangeur L 282 - Ø 90	APPLICATION Man R39 18410/430 HOCL, Fast Syter A51, Lion's Regio R12, R13, R14 - Lion's City A21, A22, A23 - Lion's Coach R07, R08 Neoplan Starliner P12, Cityliner P14, P15, P16, Tourliner P20, P21, P22, Trendliner P23, P24, Skyliner PB1, PB2 Moteur D0836LUH 40/41/50, D2866LUH, D0836LUH 01/02, D2066LUH, D2866LOH27-29/32/33/34/35/37/38, D2866LOH20-26/30/31	
<b>RÉF ATS</b> <b>72991</b>	DÉSIGNATION Durite d'échangeur L 102 - Ø 80	APPLICATION Fast Scoler A91, Fast Syter, Man SUE A72 Moteur D2866LUH 20/21/22/26, D0836LOH 01/02/03/04, D2066LUH 01/02/03/04/05/07/08/09/11-18/21-24/26- 28/41-43/47/48, D2866LUH 23/24/25/27- 30/34-37/50-52	
<b>RÉF ATS</b> <b>72993</b>	DÉSIGNATION Durite d'échangeur L 120 - Ø 90	APPLICATION Neoplan Centroliner N4516, N4520, Man Lion's City A21, A22, A23, Man SUE A72 Moteur D0836LOH 51-58/62/63, D2066LUH 01-05/07/09/11-18/21-24/26- 28/41-43/47/48	
<b>RÉF ATS</b> <b>72992</b>	DÉSIGNATION Durite d'échangeur L 130 - Ø 100	APPLICATION Fast A91 Scoler, Man SUE A72, Man A75 Lion's Classic, Man A78, Man Lion's City Moteur D2866LUH, D0836LOH 01/02/03/04 Euro 3	
<b>RÉF ATS</b> <b>90904</b>	DÉSIGNATION Durite d'échangeur L 65 - Ø 22	APPLICATION Man Lion's City, Lion's Classic, Lion's Coach, Lion's Regio, Lion's Star	
<b>RÉF ATS</b> <b>80995</b>	DÉSIGNATION Durite d'échangeur L 180 - Ø 65	APPLICATION Man Lion's City, Lion's Classic, ND/NG/NL, SUE/SL/NM - Centroliner	
<b>RÉF ATS</b> <b>90903</b>	DÉSIGNATION Durite d'échangeur L 205 - Ø 90	APPLICATION Man Lion's Classic, Lion's Coach, Lion's Regio, Lion's City, ND/NG/EL - NL/ NL/NUE- RH/SG/ SUE - Centroliner, Cityliner	

### Man, Fast, Neoplan

RÉF ATS	DÉSIGNATION	APPLICATION	
<b>90910</b>	Durite d'échangeur L 130 - Ø 120	Man Lion's Star, Lion's Star, Starliner, Tourliner	

### Scania

RÉF ATS	DÉSIGNATION	APPLICATION	
<b>92148</b>	Durite intercooler 2 spires L 140 - Ø 89	Scania série 4, série F/K/N Moteur DC9/DC11, DC-DT12, DC13	

RÉF ATS	DÉSIGNATION	APPLICATION	
<b>90648</b>	Durite intercooler 4 spires L 182 - Ø 100	Scania série 4, série F/K/N Moteur DC9/DC11, DSC9, DSI9, DC13	

RÉF ATS	DÉSIGNATION	APPLICATION	
<b>92149</b>	Durite intercooler 5 spires L 180 - Ø int 82 - Ø ext 105	Scania série 4, série F/K/N Moteur DC, DSC, DSI9, DC11	

RÉF ATS	DÉSIGNATION	APPLICATION	
<b>92152</b>	Durite entrée filtre à air Ø 97,5 - L 127,5	Scania série 4, série F/K/N Moteur DC9	

RÉF ATS	DÉSIGNATION	APPLICATION	
<b>92151</b>	Soufflet d'entrée d'air	Scania série 4 Moteur DC-DSC-DSI 9	





### Vanhool

RÉF ATS	DÉSIGNATION	APPLICATION	
<b>61977</b>	Durite Turbo 6 spires L 255 - Ø1 100 - Ø2 100	Vanhool Moteur Man	



RÉF ATS	DÉSIGNATION	APPLICATION	
<b>40706</b>	Durite turbo 3 spires L 180 - Ø1 100 - Ø2 90	Vanhool Moteur Man	

RÉF ATS	DÉSIGNATION	APPLICATION	
<b>39927</b>	Durite turbo 4 spires L 185 - Ø1 90 - Ø2 90	Vanhool Moteur Man	

## Vanhool

RÉF ATS	DÉSIGNATION	APPLICATION	
<b>63797</b>	Durite turbo droite L 120 - Ø1 90 - Ø2 90	Vanhool Moteur Man	
<b>37122</b>	Durite turbo 5 spires L 240 - Ø1 76 - Ø2 76	Vanhool Moteur Man	
<b>46558</b>	Durite turbo 6 spires L 225 - Ø1 100 - Ø2 100	Vanhool Moteur Man	
<b>42031</b>	Durite turbo 5 spires L 195 - Ø1 76 - Ø2 76	Vanhool Moteur Man	
<b>47685</b>	Durite turbo coudée 90° Ø1 90 - Ø2 100	Vanhool Moteur Man	
<b>47886</b>	Durite turbo coudée 90° Ø1 100 - Ø2 100	Vanhool Moteur Man	
<b>50742</b>	Durite coudée 2 spires L 248 - Ø1 100 - Ø2 100	Vanhool Moteur Man	

## Volvo

RÉF ATS	DÉSIGNATION	APPLICATION	
<b>90263</b>	Durite d'échangeur L 390 - Ø 80	Volvo B9L/R/S/TL, B12M	
<b>90260</b>	Durite d'échangeur L 148 - Ø 100	Volvo B9L/S/TL, B12M	
<b>90261</b>	Durite d'échangeur L 245 - Ø 76	Volvo B9R, B11R, B12B	

### Volvo

<b>RÉF ATS</b>	DÉSIGNATION	APPLICATION	
<b>90262</b>	Durite d'échangeur L 148 - Ø 100	Volvo B9R/TL, B12/M/R	
<b>RÉF ATS</b>	DÉSIGNATION	APPLICATION	
<b>90264</b>	Durite d'échangeur L 90 - Ø 100	Volvo B9TL, B12/B/M/R	
<b>RÉF ATS</b>	DÉSIGNATION	APPLICATION	
<b>90265</b>	Durite d'échangeur L 390 - Ø 80	Volvo B12M	
<b>RÉF ATS</b>	DÉSIGNATION	APPLICATION	
<b>90266</b>	Collier	Volvo B9L/R/S/TL, B12/B/M, B13R	

### TURBOS

RÉF ATS	APPLICATION	TYPE	CORRESPONDANCE	PARTICULARITÉS
<b>EVOBUS</b>				
<b>41316</b>	Evobus Mercedes			ES - OM402LA
<b>40521</b>				ES - OM422A
<b>36975</b>				ES - OM442LA
<b>45566</b>		Garett TA45		OM 441LA
<b>81751</b>	Evobus Citaro	Neuf	<b>A9060969199</b>	OM 906 LA
<b>72973</b>	Evobus Mercedes 431DT	ES	<b>A0090961799</b>	OM 502 LA
<b>77427</b>	Evobus 0814-0815 Vario	ES	<b>A9040965599</b>	OM 904 LA
<b>67167</b>	Evobus 0818 Vario	ES	<b>A9040968499</b>	OM 904 LA
<b>94420</b>	Evobus Intouro		<b>A9060969699</b>	OM 926 LA
<b>76380</b>	Evobus série 400	Schwitzer	<b>A0070967699</b>	OM 457 LA
<b>FAST</b>				
<b>61992</b>	Fast Scoler	Schwitzer	<b>5001838971</b>	Midr 060226W
<b>IRISBUS</b>				
<b>48980</b>	Irisbus Agora	HX40	<b>5001838582</b>	ES - Moteur Renault
<b>52505</b>	Irisbus Agora Line	HX40	<b>5010339648</b>	ES - Moteur Renault
<b>52398</b>		HY40	<b>5003393559</b>	ES - Moteur Cursor Iveco
<b>51249</b>	Irisbus PR100 2 /180-2/ GX107	HOLSET HIE	<b>5000686900</b>	ES



RÉF ATS	APPLICATION	TYPE	CORRESPONDANCE	PARTICULARITÉS
<b>IRISBUS</b>				
<b>47971</b>	Irisbus R312, Tracer	Garett T04B	<b>5000249777</b>	ES - MIHS 062045A
<b>55459</b>	Irisbus Tracer	HX40	<b>5000240900</b>	ES - MIHR 062045A41
<b>48912</b>	Irisbus FR1 dep 1985 jsq 1992		<b>5000670625</b>	ES - MIDR 062045C
<b>52772</b>	Irisbus FR1 dep 1992		<b>5001825521</b>	ES - MIDR 062045D/3
<b>52503</b>	Irisbus Iliade, Ares	HOLSET	<b>5001850282</b>	ES - 340CV - MIDR062045M41
<b>48054</b>	Irisbus Iliade, Ares	HOLSET	<b>5010240732</b>	ES - 300CV - MIDR062045R41
<b>53821</b>	Irisbus Axer, Recreo		<b>5001857975</b>	Neuf Cursor Iveco F2B Euro 3
<b>51289</b>	Irisbus Iveco Eurocité		<b>3530536</b>	ES
<b>60115</b>	Irisbus Iveco Scolabus	HX35W		
<b>71725</b>	Irisbus Mascott, Daily 2,8 135 CV		<b>500379251</b>	Moteur 8140.43.400
<b>58660</b>	Irisbus Midys		<b>50403588</b>	Tector Iveco
<b>72668</b>	Irisbus Evadys, Arway	ES	<b>504252235</b> <b>504252233</b>	Moteur Cursor 10
<b>78722</b>	Irisbus Citelis Diesel GX327, 427	ES	<b>504252242</b>	Moteur Cursor 8
<b>78722</b>	Irisbus Arway, Eurorider, Evadys H, Crossway, Recreo	ES	<b>504252241</b>	Moteur Cursor 8 Euro 4
<b>94305</b>	GX327, 427 Hybrid Proway Euro 4 Crossway Recreo Euro 4, 5 Citelis Hybrid CC100 E22 / CC100 E25 / CC150 E25 Crossway LE Euro 5		<b>504076871</b>	Moteur Tector Euro 5
<b>MAN</b>				
<b>50562</b>	Man			ES - D2866LOH29
<b>61114</b>	Man Sue 313			D2866LUH
<b>76197</b>	Man K31	ES	<b>51091007516</b>	D2876LOH02
<b>78837</b>	Man	ES	<b>091007487</b>	D2066LOH07
<b>79948</b>	Man	ES	<b>51091007694</b>	D2866LUH20
<b>70522</b>	Man		<b>51091009491</b>	D2866LUH24
<b>VANHOOL</b>				
<b>51993</b>	Vanhool A508		<b>51091009325</b>	ES
<b>VOLVO</b>				
<b>47926</b>	Volvo B10	HX40		Moteur DH10A 245
<b>47937</b>	Volvo B10L GX 417			ES
<b>VALVE DE TURBO HOLSET</b>				
<b>68697</b>	Recreo, Crossway			Moteur Cursor
<b>55379</b>	Citelis			Moteur Cursor

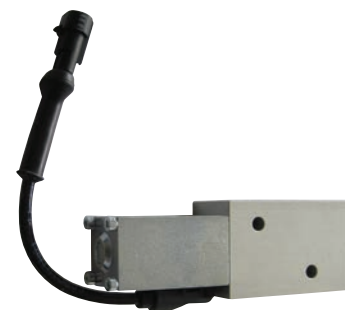

### Moteur échange standard

RÉF ATS	DÉSIGNATION	CORRESPONDANCE	PARTICULARITÉS
<b>IVECO/IRISBUS</b>			
<b>92640</b>	Daily		F1CE0481B
<b>68082</b>	Irisbus Recreo / Axer		Cursor 8 F2BE1682GB011/042201
<b>76727</b>	Irisbus Midys		Tector F4AE0682
<b>92715</b>	Irisbus Iliade / Ares		DCI11
<b>75899</b>	Irisbus Iliade / Ares		MIDR062356A41
<b>EVOBUS</b>			
<b>74628</b>	Evobus 313UL-315UL		OM447 HLA
<b>74172</b>	Evobus Tourino, Intouro		OM926 LA
<b>91014</b>	Evobus 412UL-415UL		OM457 HLA
<b>91357</b>	Evobus Turismo		OM457 LA
<b>MAN</b>			
<b>74195</b>	Man, Fast, Vanhool, Temsa		D2876LOH 01
<b>79310</b>			D2866LOH 27
<b>76913</b>			D2866TOH
<b>64017</b>			D0836LOH 02
<b>75165</b>			D0834LF
<b>94005</b>			D2066LOH07
<b>89877</b>			D2066LUH01
<b>93069</b>			D2866LOH23
<b>92865</b>			D2866LOH29
<b>RENAULT</b>			
<b>84954</b>	Trafic		G9U

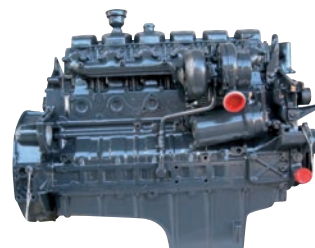

### Culasse

RÉF ATS	DÉSIGNATION	CORRESPONDANCE	PARTICULARITÉS
<b>EVOBUS</b>			
<b>71053</b>	Evobus		OM447HLA
<b>74874</b>		<b>A4570100721</b>	OM457HLA
<b>81580</b>		<b>A9060108221</b>	OM906
<b>77104</b>		<b>A9260103820</b>	OM926LA
<b>IRISBUS</b>			
<b>77390</b>	Irisbus Arway, Citelis, Crossway, Recreo, Evadys	<b>500370212</b>	Cursor 8 F2BE0682
<b>MAN</b>			
<b>65198</b>	Man		D2866LUH24
<b>75401</b>			D2866LOH





## Pochette rodage culasse

RÉF ATS	DÉSIGNATION	PARTICULARITÉS	
<b>28510</b>	Man (6 joints par culasse)	D2566 MF, MT, MTH, MXF	
<b>65064</b>	Man (3 joints de culasse par moteur)	D0836 LOH 51-58/62/63	
<b>28513</b>	Man (6 joints par culasse)	D2866 UH, LOH, TOH, TUH, LXOH, D2876 LF02, LOH01	
<b>45229</b>	Mercedes	OM407A/LA/H/HA, OM427A/LA/H/HA, OM447A/LA/H/HA/HLA	
<b>28514</b>	Mercedes	OM401, 421, 422, 422A, 422LA, 423, 441A/LA, OM442/A/LA, OM402LA	
<b>51223</b>	Mercedes	OM457HLA Euro 3, OM457LA Euro 3	
<b>55476</b>	Mercedes	OM501LA, 502LA Euro 3	
<b>41061</b>	Renault S45, S53, S105, R, RX	Man D0846HM42U (pour 2 cylindres)	
<b>48959</b>	Renault FR1, Tracer, Recreo, Ares, Iliade, PR100-2, GX107, PR180-2	MIDR0622045 (9840CM3)	
<b>43150</b>	Renault, Scoler 1, 2, GX77	MIDR060226	
<b>45783</b>	Scania	DS11, DSC11, après moteur 5307929SSS, après moteur 4070105SN	

## Kit vis de culasse

RÉF ATS	DÉSIGNATION	PARTICULARITÉS	
<b>36450</b>	Man (pour 1 culasse)	D2566 D2866LOH, LOH20, TOH, LXOH, LUH20, 21, 22, UH	
<b>55470</b>		D2866 LOH02/03/05/27/28/29/34/35 LUH 23/24/25/30, D2876 LOH02/03/05	
<b>36652</b>	Mercedes (pour 1 culasse)	OM 401LA, OM407H/HA/LA OM 421A/LA, OM 422A/LA, OM 427A/H/HA/LA, OM 441A/LA OM 442A/LA, OM 447H/HA/LA	
<b>64953</b>		OM 501LA, 502LA	

## Filtre reniflard séparateur d'huile

RÉF ATS	DÉSIGNATION	PARTICULARITÉS	
<b>37039</b>	Man	D2866 LXOH/LOH 02/03/06/07/20-26/30/31, D2876 LF01-03/06/08-10/14/17, D2876 LOH01	
<b>47745</b>	Mercedes	OM 401, 402, 421, 422, 441, 442	
<b>61542</b>		OM 501LA, 502LA	

### Iveco Cursor 8

RÉF ATS	VUE	DÉSIGNATION	QTÉ	PARTICULARITÉS
<b>86747</b>		Pochette de rodage	1	F2BE 0642 A/B/C/D/F, F2BE 0681 A/C/D, F2BE 0682 A/B/C/D/F
<b>86773</b>		Pochette de rodage	1	F2BE 3681 A/C
<b>86743</b>	1	Pochette de joints d'injecteurs	6	
<b>86713</b>	2	Joint de culasse	1	
<b>86723</b>	3	Joint de cache-culbuteurs	1	
<b>86733</b>	4	Joint de collecteur d'admission	2	
<b>86542</b>	5	Joint de collecteur d'échappement	6	
<b>86561</b>	6	Bague d'étanchéité, tige de soupape	12	
<b>86749</b>	7	Bague d'étanchéité, vilebrequin	1	
<b>86629</b>	8	Bague d'étanchéité, vilebrequin	1	
<b>86725</b>	9	Joint de carter d'huile	1	
<b>86552</b>	10	Bague d'étanchéité	1	
<b>55366</b>	11	Joint torique pompe à eau	1	
<b>62361</b>	12	Vis culasse	1	

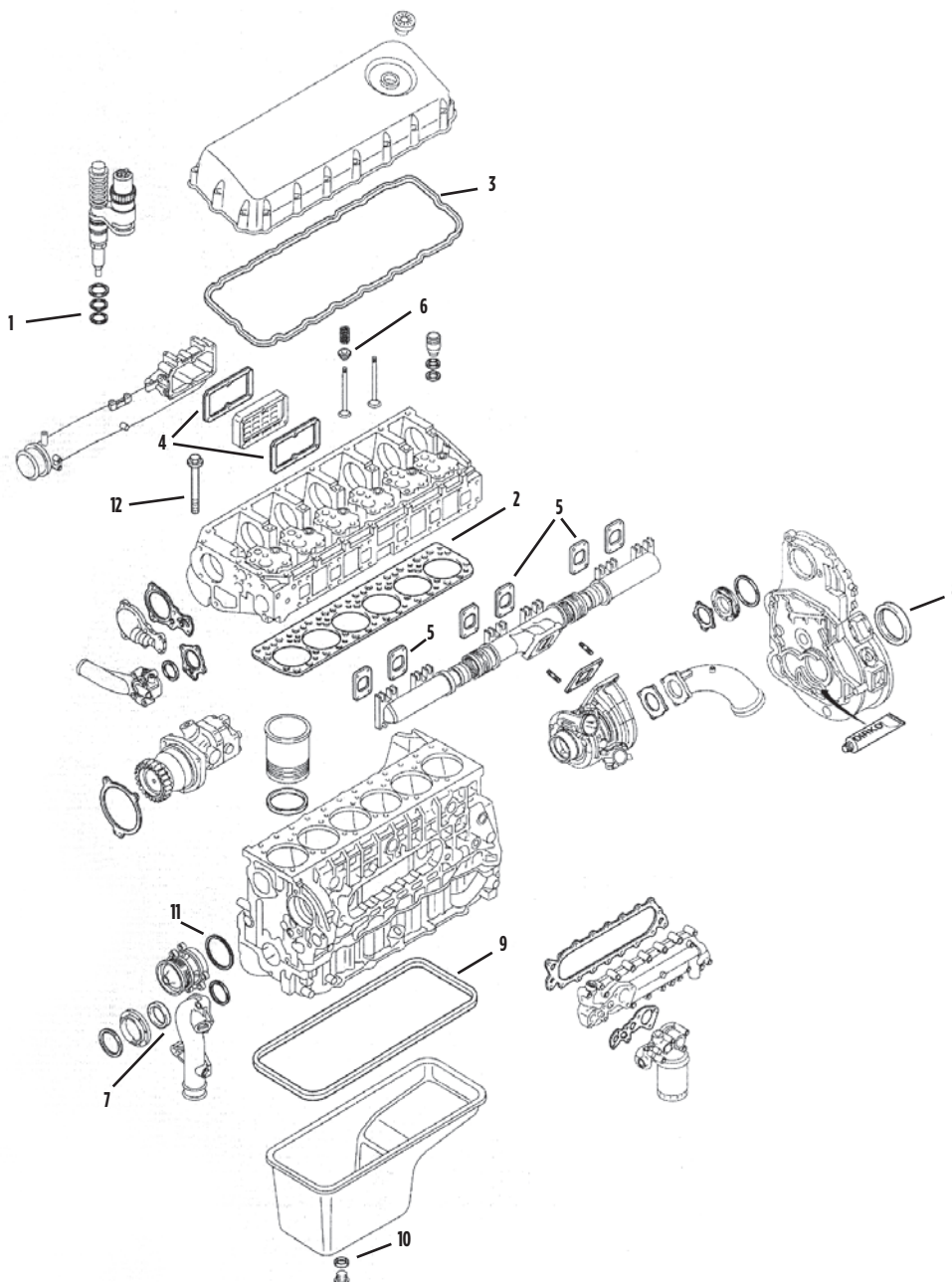

## Iveco Cursor 10

RÉF ATS	VUE	DÉSIGNATION	QTÉ	PARTICULARITÉS
<b>86776</b>		Pochette de rodage	1	F3AE 3681 A/B/D
<b>86746</b>		Pochette de visite	6	
<b>86712</b>	1	Joint de culasse	1	
<b>86724</b>	2	Joint de cache-culbuteurs	1	
<b>86733</b>	3	Joint de collecteur d'admission	2	
<b>86745</b>	4	Joint de collecteur d'échappement	6	
<b>86719</b>	5	Bague d'étanchéité, tige de soupape	12	
<b>85245</b>	6	Joint torique compresseur	1	
<b>86665</b>	7	Bague d'étanchéité, vilebrequin	1	
<b>86663</b>	8	Bague d'étanchéité, vilebrequin	1	
<b>72341</b>	9	Joint	1	
<b>86714</b>	10	Joint de carter d'huile	1	

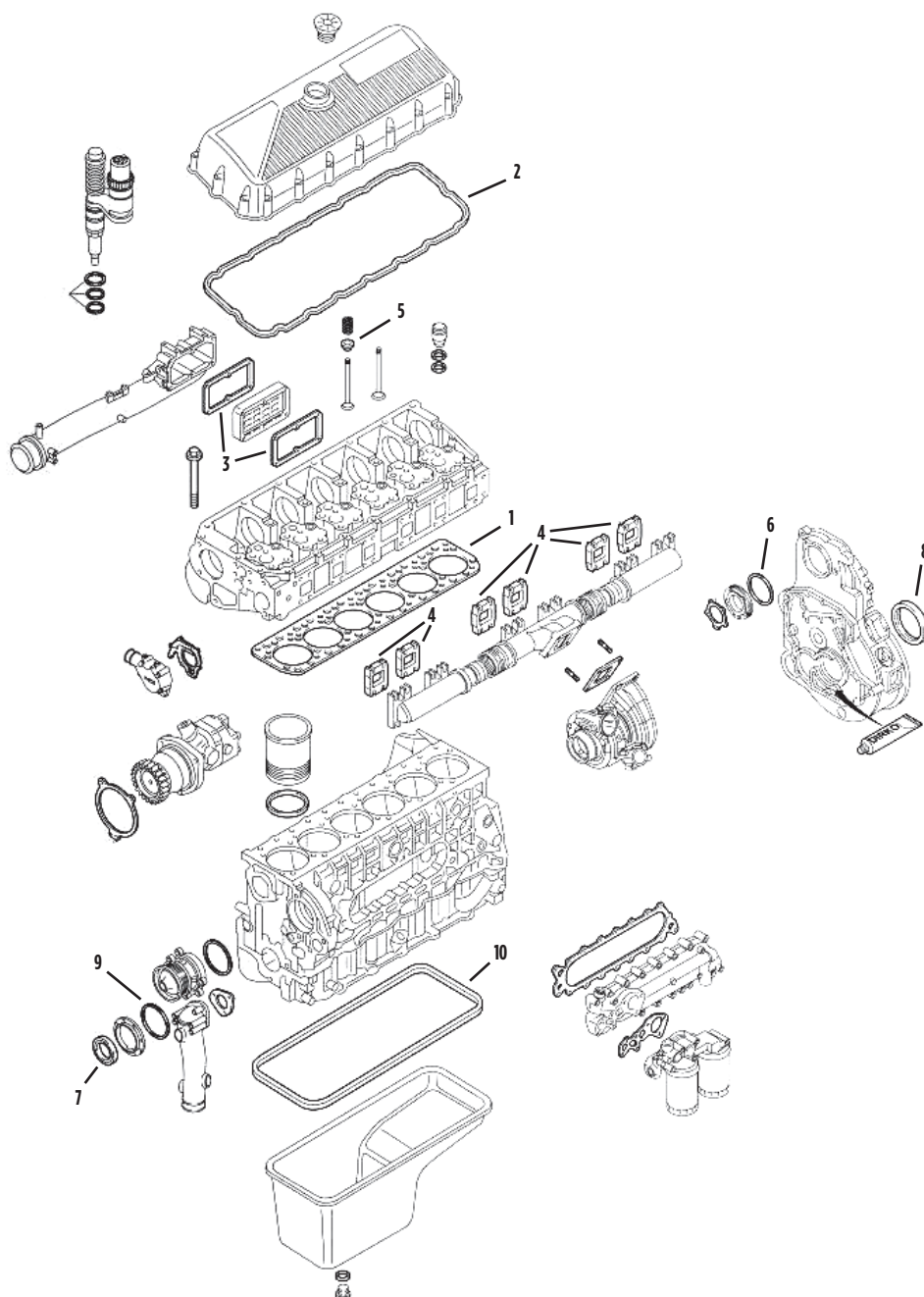

### Man D0826 - D0836

RÉF ATS	VUE	DÉSIGNATION	QTÉ	PARTICULARITÉS
<b>91451</b>		Pochette complète - Carter alu	1	D0826LF
<b>91452</b>		Pochette complète - Carter acier	1	D0826LF
<b>91453</b>		Pochette complète	1	D0826GF
<b>91454</b>		Pochette complète	1	D0836LF/LOH
<b>90923</b>		Pochette rodage D0826	3	D0826
<b>91455</b>		Pochette de rodage	3	D0836
<b>86584</b>		Pochette de cache-culbuteurs	1	D0836LF41-44/LFG50/ LFL40-55/LOH40-63/ LUH40-50
<b>91456</b>		Jeu de vis de culasse	3	
<b>86585</b>		Vis de culasse	3	D0836LF41-44/LFG50/ LFL40-55/LOH40-63/ LUH40-50
<b>86817</b>	1	Joint de culasse	3	
<b>86739</b>	2	Joint de cache-culbuteurs	3	D0836
<b>86550</b>	2	Joint de cache-culbuteurs	1	D0836LF41-44/LFG50/ LFL40-55/LOH40-63/ LUH40-50
<b>86623</b>	3	Joint de collecteur d'admission	6	
<b>86605</b>	4	Joint de collecteur d'échappement	6	
<b>86578</b>	4	Joint de collecteur d'échappement	4	D0836LF41-44/LFG50/ LFL40-55/LOH40-63/ LUH40-50

RÉF ATS	VUE	DÉSIGNATION	QTÉ
<b>89485</b>	5	Joint	1
<b>89489</b>	6	Joint	1
<b>86515</b>	7	Bague d'étanchéité, vilebrequin	1
<b>86699</b>	8	Bague d'étanchéité, vilebrequin	1
<b>91457</b>	9	Bague d'étanchéité	1
<b>89486</b>	10	Joint	1
<b>91458</b>	11	Joint de pompe à eau	1
<b>75733</b>	12	Joint	3
<b>90109</b>	13	Joint de carter d'huile	1
<b>86796</b>	14	Bague d'étanchéité	1
<b>91459</b>	15	Bague étanchéité boîte vitesse	1
<b>77589</b>	16	Joint de compresseur	1
<b>77591</b>	17	Diaphragme aspiration culasse compresseur	1
<b>89487</b>	18	Joint	1
<b>89488</b>	19	Joint	1
<b>91448</b>	20	Joint de refroidisseur d'huile	2
<b>91429</b>	21	Joint de tuyau d'admission	1
<b>91450</b>	22	Joint	1
<b>50835</b>	23	Joint	1
<b>50836</b>	24	Joint	1
<b>91460</b>	25	Joint carter volant moteur	1
<b>86610</b>	NR	Bague d'étanchéité, tige de soupape	6

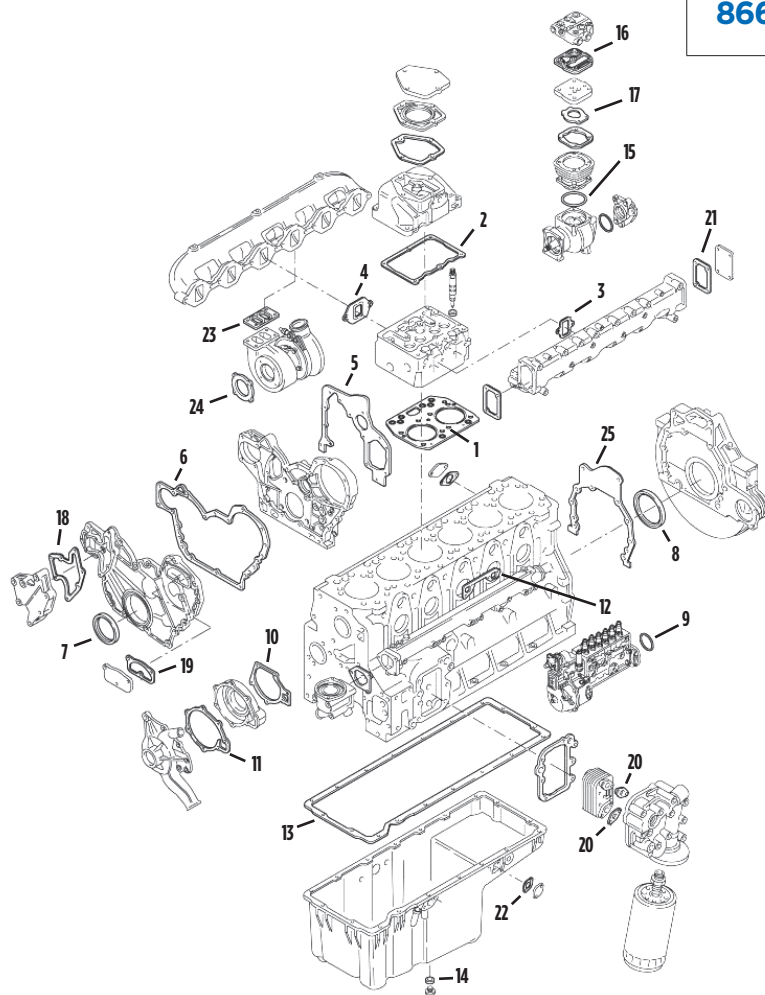

## Man D2066LF/LUH

RÉF ATS	VUE	DÉSIGNATION	QTÉ	PARTICULARITÉS
<b>91419</b>		Pochette complète	1	D2066 LF01-04/6/7/11-20/21-39
<b>91391</b>		Pochette complète	1	D2066 LF17-30 jsq XXX1414257XXXX
<b>91392</b>		Pochette complète	1	D2066 LF17-30 à partir de XXX1414257XXXX
<b>91449</b>		Pochette complète	1	D2066 LOH10/12
<b>89497</b>		Pochette rodage	1	
<b>89499</b>		Pochette rodage	1	D2066 LF17-30 à partir de XXX1414257XXXX
<b>91408</b>		Pochette de cache-culbuteurs	1	LF/LOH
<b>86754</b>		Pochette de cache-culbuteurs	1	D2066LF/LOH 430 PS
<b>89918</b>	31	Jeu de 26 vis culasse D20	1	
<b>86491</b>	1	Joint de culasse	1	
<b>89498</b>	2	Joint de cache-culbuteur	1	
<b>86487</b>	3	Joint de collecteur d'échappement	6	
<b>86805</b>	4	Bague d'étanchéité, tige de soupape	24	
<b>86576</b>	5	Bague d'étanchéité, vilebrequin	1	
<b>91447</b>	6	Bague d'étanchéité, vilebrequin	1	
<b>91399</b>	7	Joint de carter de distribution	1	
<b>89920</b>	8	Joint moteur D20	1	
<b>89921</b>	9	Joint de pompe à eau	1	
<b>91412</b>	10	Bague d'étanchéité	1	

RÉF ATS	VUE	DÉSIGNATION	QTÉ
<b>91411</b>	11	Bague d'étanchéité	1
<b>91398</b>	12	Joint de thermostat	1
<b>86533</b>	13	Joint de thermostat	2
<b>91397</b>	14	Joint de thermostat	1
<b>91395</b>	15	Joint de refroidisseur d'huile	1
<b>86682</b>	16	Joint de carter d'huile	1
<b>86571</b>	17	Bague d'étanchéité	1
<b>91396</b>	18	Joint de recyclage des gaz d'échappement	2
<b>91400</b>	19	Joint de recyclage des gaz d'échappement	1
<b>91394</b>	20	Joint de recyclage des gaz d'échappement	1
<b>91420</b>	21	Écran thermique, injecteur	6
<b>86796</b>	22	Bague d'étanchéité	1
<b>86782</b>	23	Joint de refroidisseur d'huile	2
<b>91444</b>	24	Joint de collecteur d'admission	2
<b>86567</b>	25	Joint de chemise de cylindre	12
<b>91421</b>	26	Joint de pompe à eau	1
<b>91401</b>	27	Bague d'étanchéité, turbocompresseur	1
<b>91415</b>	28	Joint de turbocompresseur	1
<b>91409</b>	29	Joint de turbocompresseur	1
<b>91393</b>	30	Vis de cache-culbuteurs	18

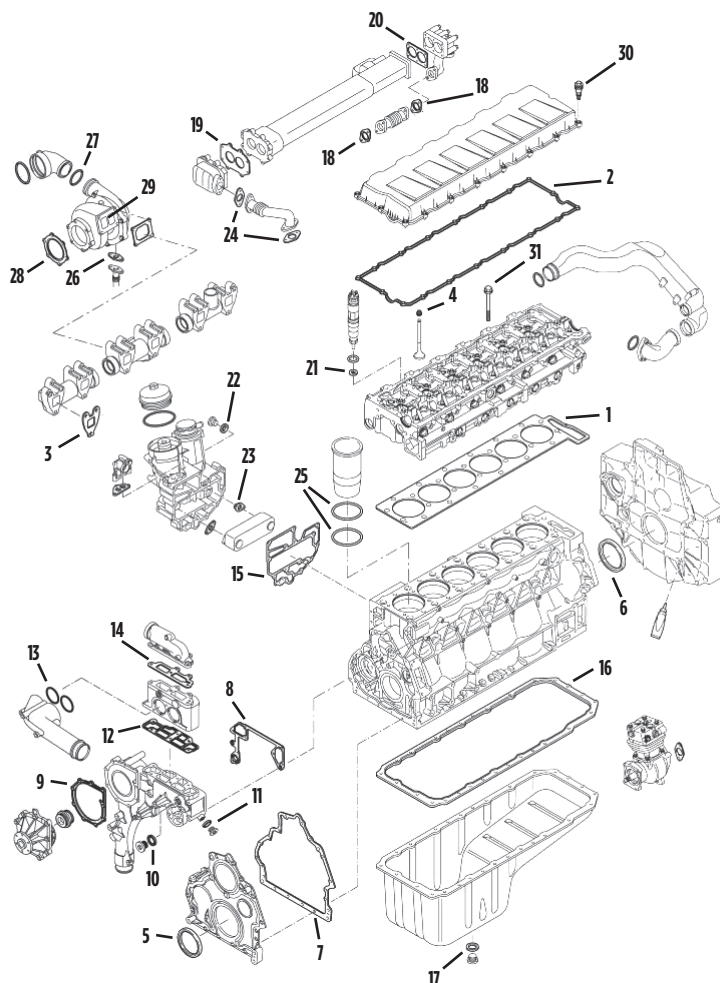

### Man D2066LUH

RÉF ATS	VUE	DÉSIGNATION	QTÉ
<b>89505</b>		Pochette de rodage	1
<b>89918</b>		Jeu de 26 vis culasse D20	1
<b>86491</b>	1	Joint de culasse	1
<b>86581</b>	2	Joint de cache-culbuteurs	1
<b>86546</b>	3	Joint de cache-culbuteurs	6
<b>86805</b>	4	Bague d'étanchéité, tige de soupape	24
<b>86750</b>	4	Bague d'étanchéité, tige de soupape	12
<b>86576</b>	5	Bague d'étanchéité, vilebrequin	1
<b>61361</b>	6	Joint spy	1
<b>91447</b>	7	Bague d'étanchéité, vilebrequin	1
<b>89920</b>	8	Joint moteur d20	1
<b>89921</b>	9	Joint de pompe à eau	1
<b>91412</b>	10	Bague d'étanchéité	1
<b>91411</b>	11	Bague d'étanchéité	1
<b>91398</b>	12	Joint de thermostat	1
<b>86533</b>	13	Joint de thermostat	2
<b>91397</b>	14	Joint de thermostat	1

RÉF ATS	VUE	DÉSIGNATION	QTÉ
<b>91395</b>	15	Joint de refroidisseur d'huile	1
<b>91423</b>	16	Joint de refroidisseur d'huile	1
<b>86682</b>	17	Joint de carter d'huile	1
<b>86571</b>	18	Bague d'étanchéité	1
<b>86619</b>	19	Joint tuyau d'échappement	2
<b>91430</b>	20	Joint de recyclage des gaz d'échappement	1
<b>89919</b>	21	Joint cuivre injecteur	6
<b>86482</b>	22	Bague d'étanchéité	6
<b>91413</b>	23	Bague d'étanchéité	
<b>86683</b>	24	Joint de collecteur d'échappement	1
<b>91424</b>	25	Joint de filtre à huile	1
<b>86567</b>	26	Joint de chemise de cylindre	12
<b>91421</b>	27	Joint de pompe à eau	1
<b>91445</b>	28	Bague d'étanchéité	1
<b>91415</b>	29	Joint de turbocompresseur	2
<b>91409</b>	30	Joint de turbocompresseur	1
<b>89918</b>	31	Jeu de 26 vis culasse D20	1

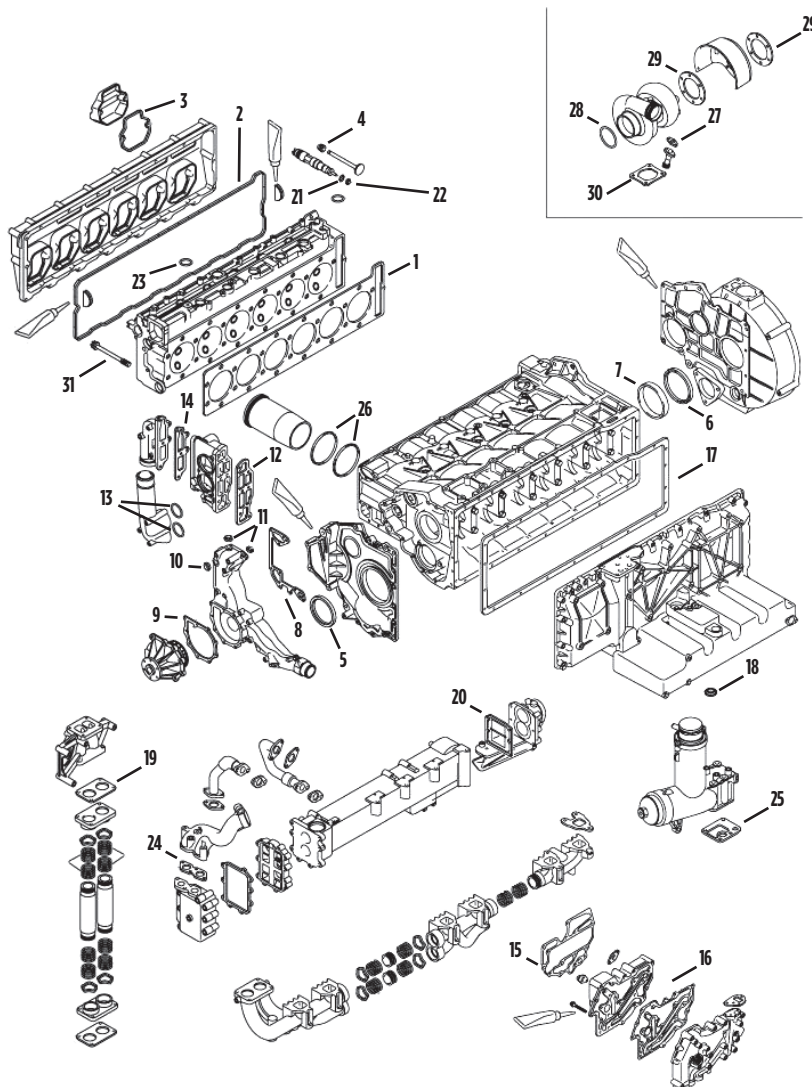

**Man D2866 4V / D 2876 4V Man, D 2866 LOH 27-29/32-34,  
D 2866 LF23 / 24 / 25 / 26 / 27 / 28 / 30 / 31 / 32 / 24 / 35 / 36 / 37 / 41,  
D 2876 LF 03-11 / 14 / 17 / 20, D 2876 LOH 02 / 03 / 05**

RÉF ATS	DÉSIGNATION	QTÉ	REPÈRE
<b>86516</b>	Pochette complète	1	S
<b>86611</b>	Pochette rodage	6	ES
<b>86622</b>	Pochette rodage	6	ES
<b>94567</b>	Pochette de complément	1	CS
<b>86717</b>	Pochette joint de chemise	6	ZLBS
<b>86595</b>	Pochette joint de chemise	6	ZLBS
<b>94568</b>	Pochette de joints	2	VAS
<b>94569</b>	Pochette de joints de refroidisseur	1	OXS
<b>86489</b>	Jeu de vis de culasse	6	ZKS
<b>86535</b>	Joint de culasse	6	1
<b>86810</b>	Joint de culasse	6	1
<b>86546</b>	Joint de cache culbuteur	5	2
<b>86547</b>	Joint de cache culbuteur	1	2
<b>86620</b>	Joint de collecteur admission	6	3
<b>86787</b>	Joint de collecteur échappement	6	4
<b>86805</b>	Bague d'étanchéité tige de soupape	24	5
<b>94570</b>	Joint de couter de distribution	1	7
<b>94571</b>	Pate à joint dirka rouge	1	8
<b>94572</b>	Bague d'étanchéité	1	9

RÉF ATS	DÉSIGNATION	QTÉ	REPÈRE
<b>94573</b>	Pochette de complément	1	9/1
<b>94574</b>	Bague d'étanchéité	1	10
<b>86809</b>	Pochette de complément	1	10/1
<b>94562</b>	Joint de couvercle de carter	1	11
<b>94563</b>	Bague d'étanchéité	1	14
<b>94564</b>	Joint de pompe à eau	1	18
<b>86533</b>	Joint de thermostat	1	23
<b>94565</b>	Joint de thermostat	1	23/1
<b>86533</b>	Joint de thermostat	1	24
<b>94566</b>	Bague d'étanchéité	1	24/1
<b>91410</b>	Joint filtre à huile	2	27
<b>86816</b>	Joint carte d'huile	1	28
<b>86571</b>	Bague d'étanchéité	1	31
<b>86539</b>	Bague d'étanchéité	2	31/2
<b>86782</b>	Joint de refroidisseur d'huile	2	43
<b>86794</b>	Joint de chemise	12	61
<b>86554</b>	Joint de chemise	6	61
<b>86818</b>	Joint de chemise	12	62
<b>86762</b>	Kit Joint de Turbo		NR

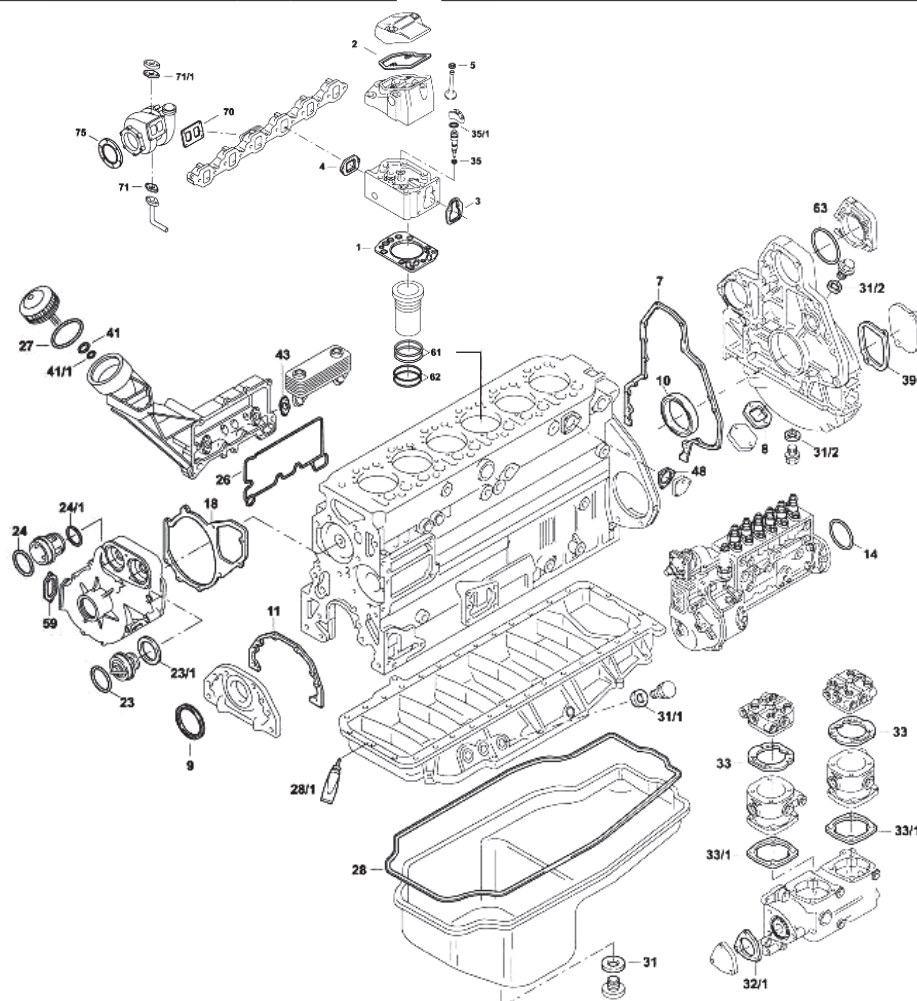

### Mercedes OM501A-LA

RÉF ATS	VUE	DÉSIGNATION	QTÉ	PARTICULARITÉS
<b>86503</b>	1	Joint de culasse	6	Jsq 357748
<b>86520</b>	1	Joint de culasse	6	À partir de 357749
<b>86514</b>	2	Joint de cache-culbuteurs	6	À partir de 084423
<b>86752</b>	2	Joint de cache-culbuteurs	6	De 084424 à 155295
<b>86483</b>	2	Joint de cache-culbuteurs	6	À partir 155296
<b>86671</b>	3	Joint de collecteur d'admission	6	
<b>86647</b>	4	Joint de collecteur d'échappement	6	
<b>86556</b>	5	Joint de carter de distribution	1	
<b>86557</b>	6	Joint de carter de distribution	1	
<b>86672</b>	7	Joint de carter de distribution	1	
<b>86568</b>	7	Joint de carter de distribution	1	
<b>86704</b>	8	Bague d'étanchéité, vilebrequin	1	
<b>86621</b>	8	Bague d'étanchéité, vilebrequin	1	
<b>86720</b>	9	Bague d'étanchéité, vilebrequin	1	
<b>86618</b>	9	Bague d'étanchéité, vilebrequin	1	
<b>86748</b>	10	Joint de couvercle de carter de vilebrequin	1	
<b>86528</b>	10	Joint de carter de distribution	1	
<b>86569</b>	11	Bague d'étanchéité, injection	6	
<b>86570</b>	12	Bague d'étanchéité, injection	6	
<b>86795</b>	13	Joint de pompe à eau	1	
<b>86731</b>	14	Bague d'étanchéité, pont de pompe à eau	1	
<b>86688</b>	15	Joint de thermostat	2	
<b>91435</b>	16	Joint de carter d'huile	1	Alu jsq 012090
<b>91406</b>	16	Joint de carter d'huile	1	Plastique à partir de 012091
<b>91443</b>	16	Joint de carter d'huile	1	Plastique

RÉF ATS	VUE	DÉSIGNATION	QTÉ
<b>86783</b>	17	Joint de pompe à huile	1
<b>86549</b>	18	Bague d'étanchéité	1
<b>86552</b>	18	Bague d'étanchéité	1
<b>89922</b>	18	Joint de vidange OM457	1
<b>86482</b>	18	Bague d'étanchéité	1
<b>86661</b>	19	Joint de compresseur d'air	2
<b>86640</b>	20	Joint de compresseur d'air	1
<b>86548</b>	21	Écran thermique, injection	6
<b>86709</b>	21	Écran thermique, injection	6
<b>86523</b>	22	Bague d'étanchéité, injection	6
<b>86482</b>	23	Bague d'étanchéité	6
<b>86785</b>	24	Bague d'étanchéité	6
<b>86590</b>	25	Joint de pompe à eau	1
<b>86502</b>	26	Joint de refroidisseur d'huile	1
<b>86577</b>	27	Joint de chemise de cylindre	6
<b>86572</b>	27	Joint de chemise de cylindre	6
<b>86767</b>	28	Joint de chemise de cylindre	12
<b>86775</b>	29	Bague d'étanchéité, prise de force	1
<b>86780</b>	30	Joint de turbocompresseur	1
<b>86779</b>	31	Joint de turbocompresseur	1
<b>86706</b>	31	Joint métallique	1
<b>86598</b>	32	Bague d'étanchéité, turbocompresseur	2

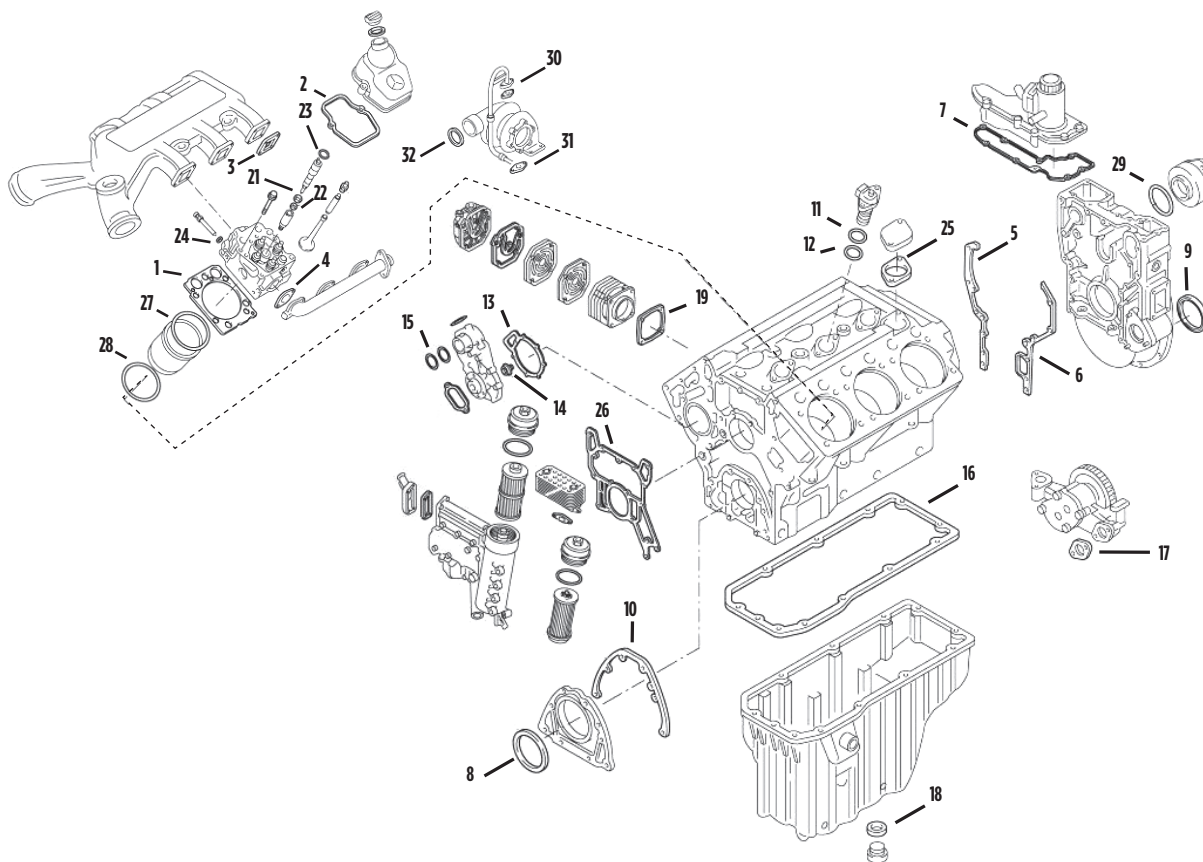

## Mercedes OM502A-LA

RÉF ATS	VUE	DÉSIGNATION	QTÉ
<b>91416</b>		Pochette complète	1
<b>91417</b>		Pochette complète	1
<b>91440</b>		Pochette complète	1
<b>91441</b>		Pochette complète	1
<b>91437</b>		Pochette complète	1
<b>86657</b>		Pochette de rodage	8
<b>91414</b>		Pochette de rodage	8
<b>86753</b>		Pochette de rodage	8
<b>86484</b>		Pochette de rodage	8
<b>86606</b>		Pochette de rodage	8
<b>86658</b>		Pochette de complément	1
<b>86673</b>		Pochette de complément	1
<b>86649</b>		Pochette de complément	1
<b>86768</b>		Pochette de joints de chemises	8
<b>86670</b>		Pochette de joints de pompe à eau	1
<b>86738</b>		Pochette de carter de distribution	1
<b>86631</b>		Pochette de carter de distribution	1
<b>86519</b>		Pochette de joints d'injecteur	8
<b>86609</b>		Pochette de visite	6
<b>91422</b>		Pochette de compresseur d'air	1
<b>91403</b>		Jeu de vis de culasse	8
<b>86503</b>	1	Joint de culasse	8
<b>86520</b>	1	Joint de culasse	8
<b>86514</b>	2	Joint de cache-culbuteurs	8
<b>86752</b>	2	Joint de cache-culbuteurs	8
<b>86483</b>	2	Joint de cache-culbuteurs	8
<b>86671</b>	3	Joint de collecteur d'admission	8
<b>86647</b>	4	Joint de collecteur d'échappement	8
<b>91439</b>	5	Bague d'étanchéité, tige de soupape	24
<b>86556</b>	6	Joint de carter de distribution	1
<b>86557</b>	7	Joint de carter de distribution	1
<b>86672</b>	8	Joint de carter de distribution	1
<b>86568</b>	8	Joint de carter de distribution	1
<b>86704</b>	9	Bague d'étanchéité, vilebrequin	1
<b>86621</b>	9	Bague d'étanchéité, vilebrequin	1
<b>86720</b>	10	Bague d'étanchéité, vilebrequin	1
<b>86618</b>	10	Bague d'étanchéité, vilebrequin	1
<b>86748</b>	11	Joint de couvercle de carter de vilebrequin	1
<b>86528</b>	11	Joint de carter de distribution	1
<b>86569</b>	12	Bague d'étanchéité, injection	8
<b>86570</b>	13	Bague d'étanchéité, injection	8
<b>86795</b>	14	Joint de pompe à eau	1
<b>86731</b>	15	Bague d'étanchéité, pont de pompe à eau	1
<b>86688</b>	16	Joint de thermostat	2
<b>86652</b>	17	Joint de carter d'huile	1
<b>86700</b>	17	Joint de carter d'huile	1

RÉF ATS	VUE	DÉSIGNATION	QTÉ
<b>86783</b>	18	Joint de pompe à huile	1
<b>86549</b>	19	Bague d'étanchéité	1
<b>86552</b>	19	Bague d'étanchéité	1
<b>89922</b>	19	Joint de vidange OM457	1
<b>86482</b>	19	Bague d'étanchéité	1
<b>86661</b>	20	Joint de compresseur d'air	2
<b>86640</b>	21	Joint de compresseur d'air	1
<b>86548</b>	22	Écran thermique, injection	8
<b>86709</b>	22	Écran thermique, injection	8
<b>86523</b>	23	Bague d'étanchéité, injection	8
<b>86482</b>	24	Bague d'étanchéité	8
<b>86785</b>	25	Bague d'étanchéité	8
<b>86590</b>	26	Joint de pompe à eau	1
<b>86502</b>	27	Joint de refroidisseur d'huile	1
<b>86577</b>	28	Joint de chemise de cylindre	8
<b>86572</b>	28	Joint de chemise de cylindre	8
<b>86767</b>	29	Joint de chemise de cylindre	16
<b>86775</b>	30	Bague d'étanchéité, prise de force	1
<b>86780</b>	31	Joint de turbocompresseur	2
<b>86779</b>	32	Joint de turbocompresseur	1
<b>86706</b>	32	Joint métallique	1
<b>86598</b>	33	Bague d'étanchéité, turbocompresseur	4

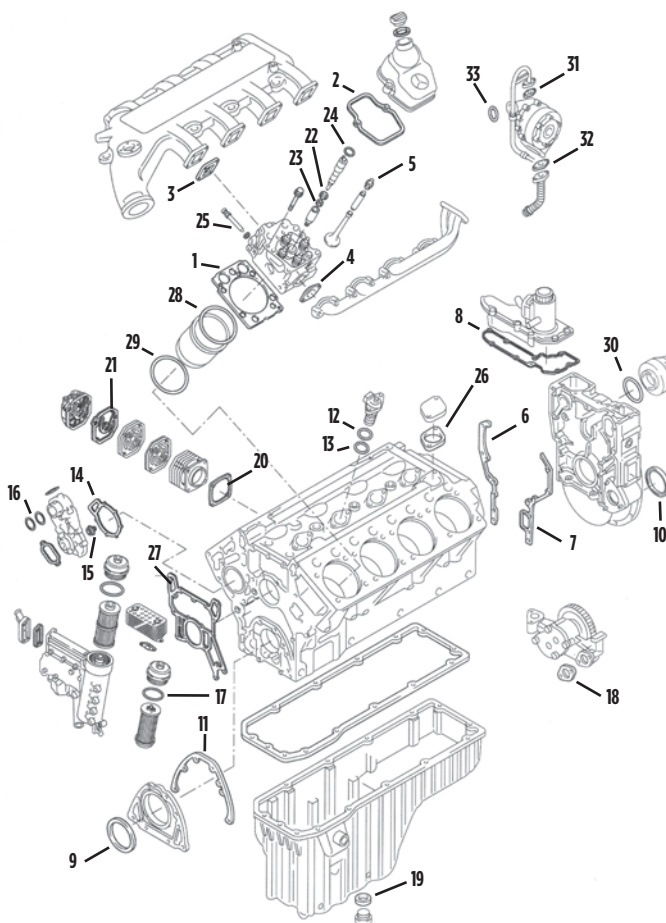

## Mercedes OM906LA

RÉF ATS	VUE	DÉSIGNATION	QTÉ
<b>86512</b>		Pochette complète	1
<b>91405</b>		Pochette de rodage	1
<b>91404</b>		Pochette de rodage	1
<b>86653</b>		Pochette de complément	1
<b>86526</b>		Pochette de cache-culbuteurs	1
<b>86560</b>		Pochette de cache-culbuteurs	1
<b>86517</b>		Pochette de joints d'injecteur	1
<b>91442</b>		Pochette de visite	1
<b>91402</b>		Jeu de vis de culasse	1
<b>86565</b>		Pochette de joints de compresseur	1
<b>86530</b>	1	Joint de culasse	1
<b>86496</b>	2	Joint de cache-culbuteurs	1
<b>86521</b>	2	Joint de cache-culbuteurs	1
<b>86495</b>	3	Joint de cache-culbuteurs	1
<b>86612</b>	3	Joint de cache-culbuteurs	1
<b>86641</b>	4	Joint de collecteur d'admission	3
<b>86678</b>	4	Joint de collecteur d'admission	6
<b>91428</b>	5	Joint de collecteur d'échappement	3
<b>86674</b>	5	Joint de collecteur d'échappement	3
<b>86608</b>	6	Bague d'étanchéité, tige de soupape	18
<b>86536</b>	6	Bague d'étanchéité, tige de soupape	18
<b>86651</b>	7	Bague d'étanchéité, vilebrequin	1
<b>91433</b>	8	Bague d'étanchéité, vilebrequin	1
<b>86618</b>	8	Bague d'étanchéité, vilebrequin	1
<b>91427</b>	9	Joint de pompe à carburant	1
<b>86654</b>	10	Bague d'étanchéité, pompe à injection	6
<b>91425</b>	10	Bague d'étanchéité, pompe à injection	6
<b>86655</b>	11	Bague d'étanchéité	6
<b>91434</b>	12	Joint de filtre à carburant	1
<b>86589</b>	13	Joint de pompe à eau	1
<b>86533</b>	14	Joint de thermostat	2
<b>91432</b>	15	Joint de tuyau d'eau de refroidisse	1
<b>91436</b>	15	Joint de pompe à eau	1
<b>91431</b>	16	Joint de carter de filtre à air	1
<b>91410</b>	17	Joint de filtre à huile	1
<b>86781</b>	18	Joint de carter d'huile	1
<b>91407</b>	18	Joint de carter d'huile	1
<b>86551</b>	18	Joint de carter d'huile	1
<b>89922</b>	19	Joint de vidange OM457	1
<b>86656</b>	20	Bague d'étanchéité, compresseur	1
<b>86548</b>	21	Écran thermique, injection	6
<b>86523</b>	22	Bague d'étanchéité, injection	6

RÉF ATS	VUE	DÉSIGNATION	QTÉ
<b>86482</b>	23	Bague d'étanchéité	6
<b>86593</b>	24	Joint de refroidisseur d'huile	1
<b>86764</b>	24	Joint de refroidisseur d'huile	1
<b>86779</b>	25	Joint de turbocompresseur	1
<b>86706</b>	25	Joint métallique	1
<b>86780</b>	26	Joint de turbocompresseur	1
<b>86604</b>	27	Bague d'étanchéité, turbocompresseur	1
<b>86539</b>	28	Bague d'étanchéité	1
<b>86549</b>	29	Bague d'étanchéité	1
<b>81637</b>	30	Joint vis de cache-culbuteurs	7
<b>86522</b>	30	Joint de vis de cache-culbuteurs	7
<b>86549</b>	31	Bague d'étanchéité	1
<b>86587</b>	32	Pochette de rodage	1
<b>86798</b>	33	Bague d'étanchéité	1
<b>86797</b>	34	Bague d'étanchéité	1
<b>86785</b>	35	Bague d'étanchéité	1

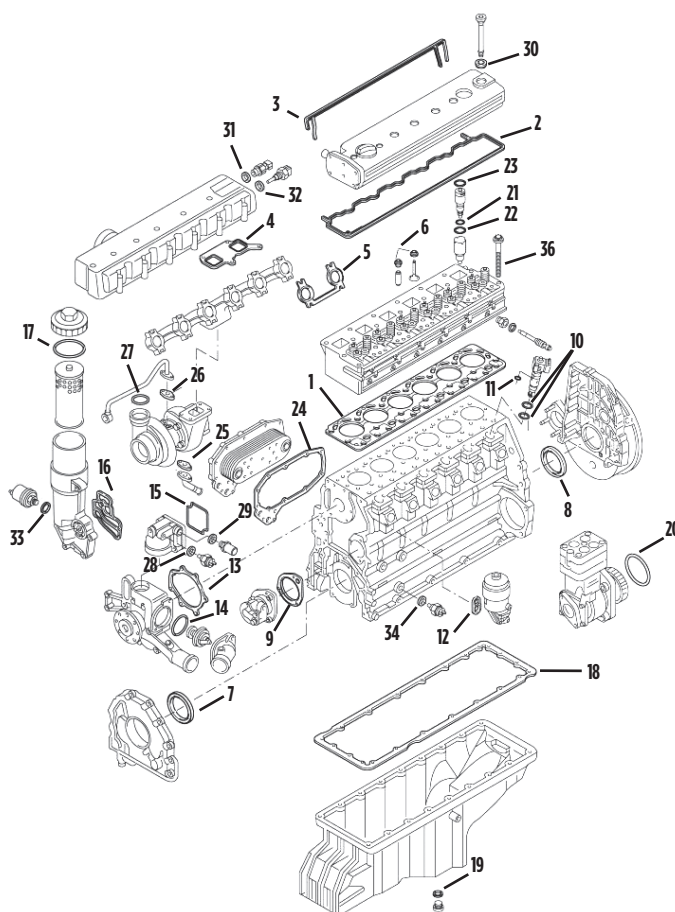

## Mercedes OM926LA

RÉF ATS	VUE	DÉSIGNATION	QTÉ
<b>91446</b>		Pochette de rodage	1
<b>86653</b>		Pochette de complément	1
<b>86560</b>		Pochette de cache-culbuteurs	1
<b>91402</b>		Jeu de vis de culasse	1
<b>91442</b>		Pochette de visite	1
<b>86679</b>	1	Joint de culasse	1
<b>86521</b>	2	Joint de cache-culbuteurs	1
<b>86612</b>	3	Joint de cache-culbuteurs	1
<b>86641</b>	4	Joint de collecteur d'admission	3
<b>86678</b>	4	Joint de collecteur d'admission	6
<b>91428</b>	5	Joint de collecteur d'échappement	3
<b>86674</b>	5	Joint de collecteur d'échappement	3
<b>86536</b>	6	Bague d'étanchéité, tige de soupape	18
<b>86651</b>	7	Bague d'étanchéité, vilebrequin	1
<b>91433</b>	8	Bague d'étanchéité, vilebrequin	1
<b>86618</b>	8	Bague d'étanchéité, vilebrequin	1
<b>91427</b>	9	Joint de pompe à carburant	1
<b>86654</b>	10	Bague d'étanchéité, pompe à injection	4
<b>91425</b>	10	Bague d'étanchéité, pompe à injection	4
<b>86655</b>	11	Bague d'étanchéité	6
<b>91434</b>	12	Joint de filtre à carburant	1
<b>86589</b>	13	Joint de pompe à eau	1
<b>86533</b>	14	Joint de thermostat	2
<b>91432</b>	15	Joint de tuyau d'eau de refroidissement	1
<b>91436</b>	15	Joint de pompe à eau	1
<b>91431</b>	16	Joint de carter de filtre à air	1
<b>91410</b>	17	Joint de filtre à huile	1
<b>86781</b>	18	Joint de carter d'huile	1
<b>91407</b>	18	Joint de carter d'huile	1
<b>86551</b>	18	Joint de carter d'huile	1
<b>89922</b>	19	Joint de vidange	1
<b>86656</b>	20	Bague d'étanchéité, compresseur	1
<b>86709</b>	21	Écran thermique, injection	6
<b>86523</b>	22	Bague d'étanchéité, injection	6
<b>86482</b>	23	Bague d'étanchéité	6
<b>86593</b>	24	Joint de refroidisseur d'huile	1
<b>86764</b>	24	Joint de refroidisseur d'huile	1
<b>86779</b>	25	Joint de turbocompresseur	1
<b>86706</b>	25	Joint métallique	1

RÉF ATS	VUE	DÉSIGNATION	QTÉ
<b>86780</b>	26	Joint de turbocompresseur	1
<b>86604</b>	27	Bague d'étanchéité, turbocompresseur	1
<b>86539</b>	28	Bague d'étanchéité	1
<b>86549</b>	29	Bague d'étanchéité	1
<b>86522</b>	30	Joint de vis de cache-culbuteurs	7
<b>86549</b>	31	Bague d'étanchéité	1
<b>86597</b>	32	Bague d'étanchéité	1
<b>86798</b>	33	Bague d'étanchéité	1
<b>86797</b>	34	Bague d'étanchéité	1
<b>86785</b>	35	Bague d'étanchéité	6

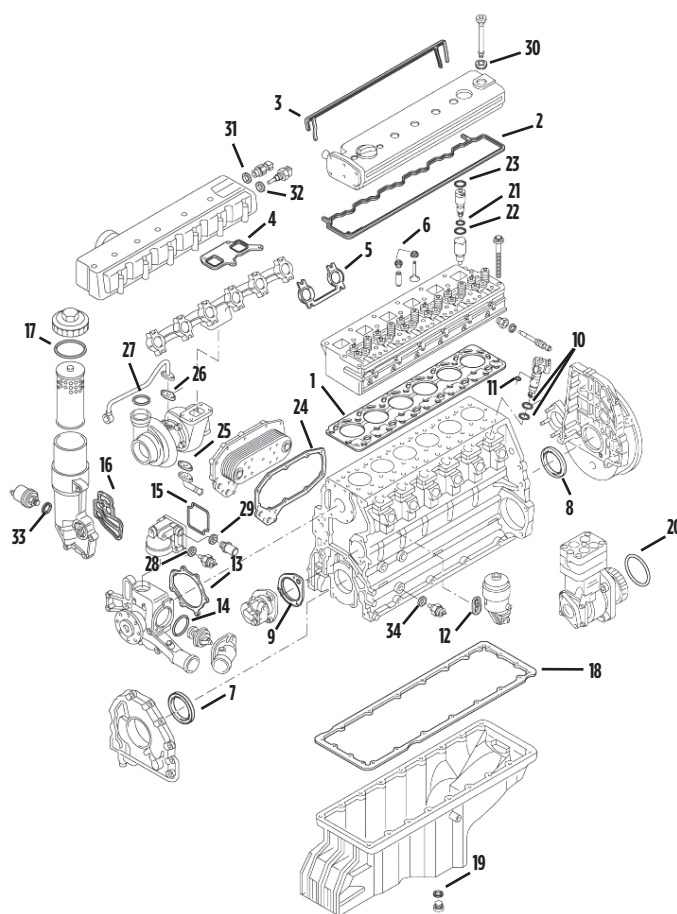

### Renault DXi7

RÉF ATS	VUE	DÉSIGNATION	QTÉ
<b>86701</b>		Pochette joint câble culbuteur DXi7	1
<b>86582</b>	1	Joint de culasse	1
<b>91418</b>	1	Joint de culasse	1
<b>86632</b>	2	Joint de cache-culbuteurs	1
<b>86744</b>	3	Joint de collecteur d'admission	6
<b>86735</b>	4	Joint de collecteur d'échappement	3
<b>86784</b>	5	Bague d'étanchéité, tige de soupape	24
<b>86532</b>		Bague d'étanchéité, vilebrequin	1
<b>86531</b>		Bague d'étanchéité, vilebrequin	1
<b>91426</b>		Joint de carter de distribution	1

RÉF ATS	VUE	DÉSIGNATION	QTÉ
<b>86553</b>		Bague d'étanchéité	1
<b>86756</b>		Bague d'étanchéité	6
<b>86537</b>		Bague d'étanchéité	12
<b>86538</b>		Bague d'étanchéité	12
<b>86555</b>		Bague d'étanchéité	1
<b>86573</b>		Joint de refroidisseur d'huile	2
<b>86575</b>		Bague d'étanchéité	1
<b>86538</b>		Bague d'étanchéité	1
<b>86537</b>		Bague d'étanchéité	5

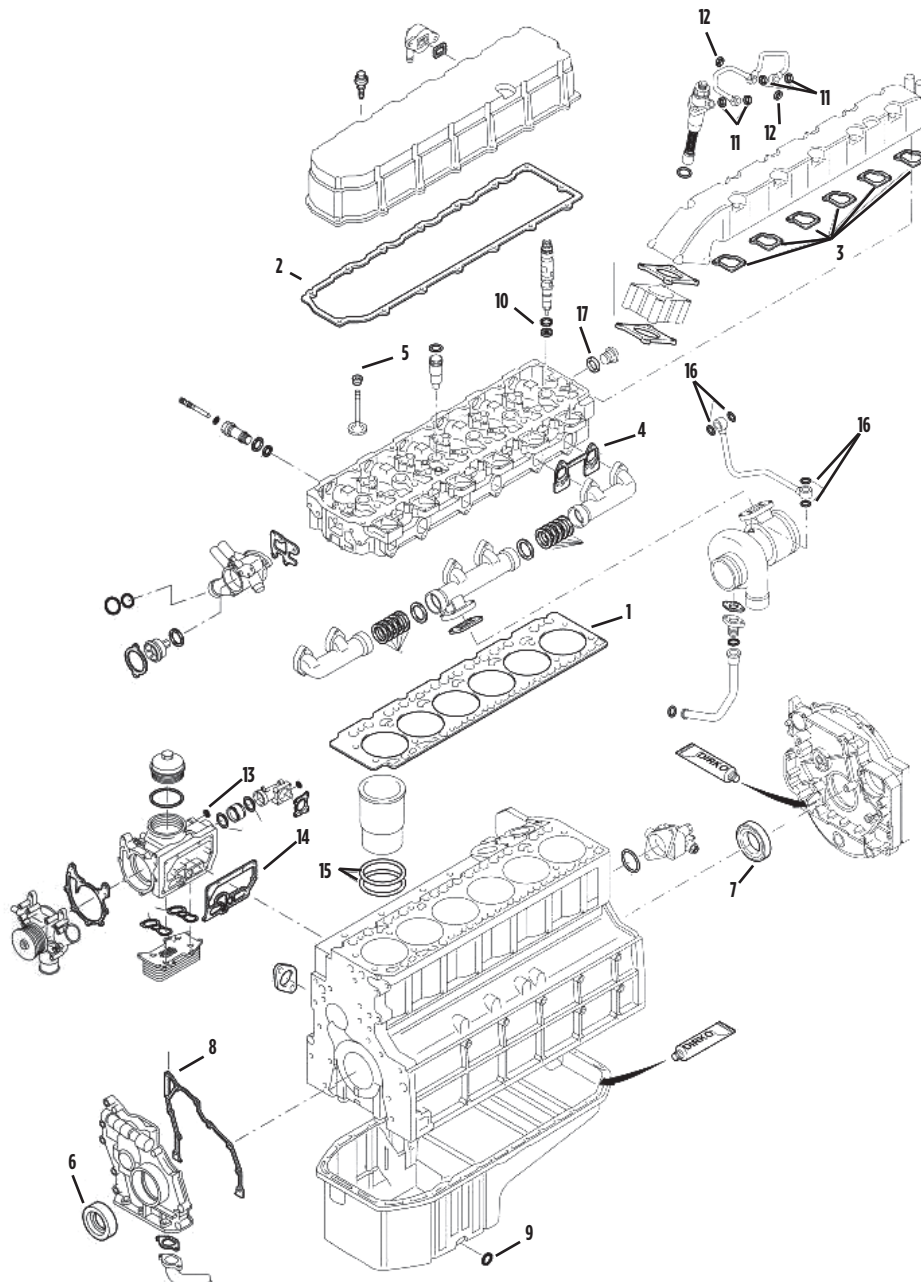

## BMC

MODÈLE PROBUS MOTEUR CUMMINS ISBE4 250 CV - DEP 2006				
DÉSIGNATION	MANN	DONALDSON	FLEETGUARD	FILTRE ORIGINE
Filtre huile	<b>54300</b>		<b>74945</b>	<b>44858</b>
Filtre gasoil	<b>53719</b>		<b>74926</b>	<b>44859</b>
Filtre air	<b>55187</b>	<b>74727</b>	<b>75454</b>	
Filtre ad blue	<b>57929</b>	<b>75705</b>		<b>56579</b>
Filtre liquide de refroidissement	<b>17861</b>			
Filtre additionnel scr	<b>63522</b>		<b>74928</b>	<b>72641</b>

MODÈLE ALYOS MOTEUR ISB607 285 CV - EURO 5				
DÉSIGNATION	MANN	DONALDSON	FLEETGUARD	FILTRE ORIGINE
Filtre huile	<b>54300</b>		<b>74945</b>	
Filtre gasoil			<b>74939</b>	
Filtre air primaire		<b>75028</b>		

## Bova, VDL

MODÈLE CITEA CLE/CLF/SLF 120-310 MOTEUR PR 228S 310 CV - DEP 05/07				
DÉSIGNATION	MANN	DONALDSON	FLEETGUARD	FILTRE ORIGINE
Filtre huile	<b>55221</b>			
Filtre gasoil	<b>73056</b>			
Filtre air	<b>67031</b>	<b>74729</b>		
Boîte ZF HP500	<b>51467</b>			
Direction	<b>17592</b>	<b>75642</b>	<b>75512</b>	
AD Blue	<b>57929</b>			
Dessicateur	<b>65647</b>			

MODÈLE FLD 12-300 - FHD 12-300 MOTEUR DAF RS200L - DAF RS222L 300 CV - 01/97 - 12/00				
DÉSIGNATION	MANN	DONALDSON	FLEETGUARD	FILTRE ORIGINE
Filtre huile	<b>39944</b>			
Filtre gasoil	<b>48836</b>			
Filtre air	<b>17467</b>			

## Bova, VDL

MODÈLE FHD 12-360 MOTEUR DAF DKXAT1 354 CV - 01/82 - 12/96				
DÉSIGNATION	MANN	DONALDSON	FLEETGUARD	FILTRE ORIGINE
Filtre huile	<b>37072</b>			
Filtre gasoil	<b>35091</b>			

MODÈLE FHD 12-370 MOTEUR DAF WS268G 370 CV - 1997 - 12/2000 EURO 1 ET 2				
DÉSIGNATION	MANN	DONALDSON	FLEETGUARD	FILTRE ORIGINE
Filtre huile	<b>17756</b>			
Filtre gasoil	<b>35091</b>			
Filtre air	<b>35075</b>	<b>75688</b>	<b>75447</b>	
Filtre direction	<b>17592</b>	<b>75642</b>	<b>75512</b>	

MODÈLE FHD 12-370 MOTEUR DAF WS268G 370 CV - 1997 - 12/2000 EURO 1 ET 2				
DÉSIGNATION	MANN	DONALDSON	FLEETGUARD	FILTRE ORIGINE
Filtre huile	<b>17756</b>			
Filtre gasoil	<b>35091</b>			
Filtre air	<b>35075</b>	<b>75688</b>	<b>75447</b>	
Filtre direction	<b>17592</b>	<b>75642</b>	<b>75512</b>	

MODÈLE FHD 12-340XE - MAGIQ HD120-380 FHD 12-380XE - MAGIQ HD131-430 FHD 13-380XE - MAGIQ HD139-430 FHD 14-430XE - FHD15-430XE MOTEUR DAF XE250C1 - DAF XE280C1 DAF XE315C - DEP 2001 - 2006 EURO 3				
DÉSIGNATION	MANN	DONALDSON	FLEETGUARD	FILTRE ORIGINE
Filtre intarder	<b>51467</b>	<b>75684</b>	<b>75514</b>	<b>56339</b>
Filtre huile	<b>48001</b>			
Filtre huile centrifugeuse	<b>53002</b>		<b>75475</b>	
Filtre air Euro 3, 4 H 508 mm	<b>48991</b>	<b>74725</b>		
Filtre gasoil	<b>45156</b>			
Filtre direction	<b>17592</b>	<b>75642</b>	<b>75512</b>	
Filtre eau	<b>56407</b>			

### Bova, VDL

MODÈLE MAGIQ MHD 122 MOTEUR MX300S 410 CV, MHD 131, 139, 148 - MOTEUR MX340S 460 CV - DEP 2006 EURO 4				
DÉSIGNATION	MANN	DONALDSON	FLEETGUARD	FILTRE ORIGINE
Filtre huile	<b>57705</b>			
Filtre gasoil	<b>54563</b>			
Filtre air	<b>67031</b>	<b>74729</b>		
Filtre ad blue	<b>57929</b>	<b>75705</b>		<b>56579</b>
Filtre direction	<b>17592</b>	<b>75642</b>	<b>75512</b>	

MODÈLE FUTURA FHD 104, 120, 127 FLD 104, 120, 127 EURO 4 MOTEUR DAF PR265S 361 CV - DEP 2006				
DÉSIGNATION	MANN	DONALDSON	FLEETGUARD	FILTRE ORIGINE
Filtre huile	<b>55221</b>			
Filtre gasoil	<b>54563</b>			
Filtre air	<b>67031</b>	<b>74729</b>		
Filtre direction	<b>17592</b>	<b>75642</b>	<b>75512</b>	
Filtre ad blue	<b>57929</b>	<b>75705</b>		<b>56579</b>

MODÈLE FHD 2-129, FHD-131, FHD2-139, FHD2-148 MOTEUR MX300, MX340 - EURO 5				
DÉSIGNATION	MANN	DONALDSON	FLEETGUARD	FILTRE ORIGINE
Filtre huile	<b>57705</b>			
Filtre gasoil	<b>54563</b>			
Filtre centrifuge	<b>54155</b>			
Filtre direction	<b>17592</b>	<b>75642</b>	<b>75512</b>	
Filtre ad blue	<b>57929</b>	<b>75705</b>		<b>56579</b>
Filtre air	<b>67031</b>	<b>74729</b>		

MODÈLE LEXIO LP123-310 PE MOTEUR DAF PE2280 310 CV - 09/05				
DÉSIGNATION	MANN	DONALDSON	FLEETGUARD	FILTRE ORIGINE
Filtre huile	<b>55221</b>			
Filtre gasoil	<b>73056</b>			
Filtre huile centrifugeuse	<b>53002</b>		<b>75475</b>	
Filtre air principal	<b>55254</b>	<b>74724</b>		
Filtre air secondaire	<b>62823</b>			
Filtre direction	<b>17592</b>	<b>75642</b>	<b>75512</b>	

### Bova, VDL

MODÈLE SYNERGY DD138-480XE MOTEUR XE355C 483 CV - DEP 10/05				
DÉSIGNATION	MANN	DONALDSON	FLEETGUARD	FILTRE ORIGINE
Filtre huile	<b>55221</b>			
Filtre gasoil	<b>73056</b>			
Filtre séparateur d'eau	<b>75325</b>			
Filtre centrifuge	<b>53002</b>			
Filtre air	<b>55254</b>			
Filtre dessiccateur	<b>65647</b>			
Filtre direction	<b>17592</b>	<b>75642</b>	<b>75512</b>	

MODÈLE SYNERGY SSD130/138/141 MOTEUR MX340S - 460 CV MOTEUR MX375S - 510 CV - DEP 07/07				
DÉSIGNATION	MANN	DONALDSON	FLEETGUARD	FILTRE ORIGINE
Filtre huile	<b>57705</b>			
Filtre gasoil	<b>54563</b>			
Filtre centrifuge	<b>54155</b>			
Filtre séparateur d'eau	<b>75325</b>			
Filtre AD Blue	<b>57929</b>			
Filtre direction	<b>17592</b>	<b>75642</b>	<b>75512</b>	



## Evobus

MODÈLE 0345 CONNECTO EURO 1 ET 2 MOTEUR OM447HLA 252-300 CV - DEP 01/98-10/01				
DÉSIGNATION	MANN	DONALDSON	FLEETGUARD	FILTRE ORIGINE
Filtre huile	<b>35080</b>		<b>75519</b>	
Filtre gasoil	<b>13121</b>		<b>75485</b>	
Filtre air	<b>35072</b>	<b>75628</b>	<b>75464</b>	
Filtre direction	<b>17592</b>	<b>75642</b>	<b>75512</b>	

MODÈLE 0345 CONNECTO EURO 3 MOTEUR OM457HLA 250-299 CV - 11/01 - 2006				
DÉSIGNATION	MANN	DONALDSON	FLEETGUARD	FILTRE ORIGINE
Filtre huile	<b>37784</b>		<b>75529</b>	
Filtre gasoil	<b>38058</b>		<b>75493</b>	
Filtre séparateur d'eau	<b>54292</b>			
Filtre air	<b>42318</b>		<b>75462</b>	
Filtre direction	<b>17592</b>	<b>75642</b>	<b>75512</b>	
Filtre hydraulique ventilateur* - Euro 1	<b>56332</b>		<b>75534</b>	

MODÈLE 0350 TOURISMO MOTEUR OM442LA 381 CV - MOTEUR OM441LA 340 CV - 09/95 - 09/02 - EURO 1 ET 2				
DÉSIGNATION	MANN	DONALDSON	FLEETGUARD	FILTRE ORIGINE
Filtre huile	<b>35083</b>		<b>75564</b>	
Filtre gasoil	<b>13121</b>		<b>75485</b>	
Filtre air	<b>42318</b>		<b>75462</b>	
Filtre direction	<b>17592</b>	<b>75642</b>	<b>75512</b>	

MODÈLE 0350 TOURISMO MOTEUR OM457LA 422 CV - 09/02 - 05/06 - EURO 3				
DÉSIGNATION	MANN	DONALDSON	FLEETGUARD	FILTRE ORIGINE
Filtre huile	<b>53245</b>			
Filtre gasoil	<b>38058</b>		<b>75493</b>	
Filtre séparateur d'eau	<b>35074</b>	<b>77308</b>		
Filtre air	<b>54292</b>			
Filtre direction	<b>17592</b>	<b>75642</b>	<b>75512</b>	

MODÈLE TOURISMO 2, 16, 17 EURO 4 MOTEUR OM457LA 428 CV - DEP 09/06				
DÉSIGNATION	MANN	DONALDSON	FLEETGUARD	FILTRE ORIGINE
Filtre huile	<b>53245</b>			
Filtre gasoil	<b>38058</b>		<b>75493</b>	
Filtre à air 5 par véhicule	<b>53243</b>	<b>74726</b>		
Filtre séparateur d'eau	<b>54292</b>			
Filtre direction	<b>17592</b>	<b>75642</b>	<b>75512</b>	

MODÈLE TOURISMO MOTEUR OM470LA 360/394 CV - EURO 6 DEP 07/2013				
DÉSIGNATION	MANN	DONALDSON	FLEETGUARD	FILTRE ORIGINE
Filtre huile				<b>94327</b>
Filtre gasoil				<b>94326</b>
Filtre air		<b>92219</b>		<b>94371</b>

MODÈLE 0404 MOTEUR OM441LA 340 CV, OM442LA 381 CV, OM401LA 272 CV - 09/91 - 99				
DÉSIGNATION	MANN	DONALDSON	FLEETGUARD	FILTRE ORIGINE
Filtre huile	<b>35083</b>		<b>75564</b>	
Filtre gasoil	<b>13121</b>		<b>75485</b>	
Filtre air	<b>35074</b>	<b>77308</b>		
Filtre direction	<b>17592</b>	<b>75642</b>	<b>75512</b>	

MODÈLE 0405, 0408 MOTEUR OM427H, OM447H, HA, HLA 300 CV - 11/85 - 98, 08/92 - 12/98				
DÉSIGNATION	MANN	DONALDSON	FLEETGUARD	FILTRE ORIGINE
Filtre huile	<b>35080</b>		<b>75519</b>	
Filtre gasoil	<b>13121</b>		<b>75485</b>	
Filtre air	<b>35072</b>	<b>75628</b>	<b>75464</b>	
Filtre direction	<b>17592</b>	<b>75642</b>	<b>75512</b>	
Filtre boîte automatique Mercedes	<b>48920</b>			
Filtre boîte automatique ZF HP500/590	<b>51467</b>	<b>75684</b>	<b>75514</b>	



### Evobus

MODÈLE 0510 TOURINO MOTEUR OM906LA, OM926LA 245 CV - DEP 2007 EURO 3 ET 4				
DÉSIGNATION	MANN	DONALDSON	FLEETGUARD	FILTRE ORIGINE
Filtre huile	<b>37784</b>		<b>75529</b>	
Filtre gasoil	<b>36820</b>		<b>75492</b>	
Filtre air	<b>55187</b>	<b>74727</b>	<b>75454</b>	
Filtre séparateur d'eau (OM926LA)	<b>54292</b>		<b>75508</b>	
Filtre direction	<b>17592</b>	<b>75642</b>	<b>75512</b>	

MODÈLE CITARO MOTEUR OM936LA EURO 6				
DÉSIGNATION	MANN	DONALDSON	FLEETGUARD	FILTRE ORIGINE
Filtre à huile	<b>93580</b>			<b>94329</b>
Filtre à gasoil	<b>92850</b>			
Filtre à gasoil + Préfiltre				
Filtre à air				<b>92852</b>
Filtre direction	<b>17592</b>	<b>75642</b>	<b>75512</b>	

MODÈLE 0530 CITARO MOTEUR OM906LA/HLA 231, 279 CV - 03/98 - 05/01 EURO 2				
DÉSIGNATION	MANN	DONALDSON	FLEETGUARD	FILTRE ORIGINE
Filtre huile	<b>37784</b>		<b>75529</b>	
Filtre gasoil	<b>36820</b>		<b>75492</b>	
Filtre air	<b>37506</b>	<b>78198</b>		
Filtre direction	<b>17592</b>	<b>75642</b>	<b>75512</b>	
Filtre séparateur d'eau racor R2OP	<b>58505</b>			

MODÈLE 0530 CITARO MOTEUR OM906LA/HLA 279 CV - DEP 06/01 JSQ 09/06				
DÉSIGNATION	MANN	DONALDSON	FLEETGUARD	FILTRE ORIGINE
Filtre huile	<b>37784</b>		<b>75529</b>	
Filtre gasoil	<b>36820</b>		<b>75492</b>	
Filtre air	<b>42318</b>		<b>75462</b>	
Filtre direction	<b>17592</b>	<b>75642</b>	<b>75512</b>	
Filtre séparateur d'eau	<b>54292</b>		<b>75508</b>	

MODÈLE 0530 CITARO MOTEUR OM457HLA 300, 354 CV - DEP 06/01 JSQ 09/06				
DÉSIGNATION	MANN	DONALDSON	FLEETGUARD	FILTRE ORIGINE
Filtre huile	<b>37784</b>		<b>75529</b>	
Filtre gasoil	<b>38058</b>		<b>75493</b>	
Filtre air	<b>42318</b>		<b>75462</b>	
Filtre séparateur d'eau version bio diesel	<b>57453</b>			
Filtre séparateur d'eau racor system R90D	<b>62364</b>			
Filtre séparateur d'eau racor system R90P	<b>56486</b>	<b>75675</b>	<b>75504</b>	
Préfiltre à gasoil	<b>58165</b>		<b>75501</b>	
Filtre hydraulique	<b>56332</b>		<b>75534</b>	
Filtre direction	<b>17592</b>	<b>75642</b>	<b>75512</b>	

MODÈLE 0530 CITARO MOTEUR OM457HLA 300 CV - DEP 09/06 EURO 4				
DÉSIGNATION	MANN	DONALDSON	FLEETGUARD	FILTRE ORIGINE
Filtre huile	<b>37784</b>		<b>75529</b>	
Filtre gasoil	<b>38058</b>		<b>75493</b>	
Filtre air	<b>42318</b>		<b>75462</b>	
Filtre séparateur d'eau parker racor	<b>54292</b>		<b>75508</b>	
Filtre séparateur d'eau system R90P	<b>56486</b>	<b>75675</b>	<b>75504</b>	
Préfiltre à gasoil	<b>58165</b>		<b>75501</b>	
Filtre hydraulique	<b>56332</b>		<b>75534</b>	
Filtre direction	<b>17592</b>	<b>75642</b>	<b>75512</b>	

MODÈLE 0530 CITARO K, LE MOTEUR OM457HLA 300, 353 CV - DEP 09/06 EURO 4, 5				
DÉSIGNATION	MANN	DONALDSON	FLEETGUARD	FILTRE ORIGINE
Filtre huile	<b>37784</b>		<b>75529</b>	
Filtre gasoil	<b>38058</b>		<b>75493</b>	
Filtre air	<b>36614</b>		<b>75459</b>	
Filtre direction	<b>17592</b>	<b>75642</b>	<b>75512</b>	
Filtre séparateur d'eau	<b>54292</b>		<b>75508</b>	
Préfiltre gasoil	<b>58165</b>		<b>75501</b>	

## Evobus

MODÈLE O550 INTEGRO MOTEUR OM447HLA 300 CV - 01/97 - 09/02, EURO 0, 1, 2				
DÉSIGNATION	MANN	DONALDSON	FLEETGUARD	FILTRE ORIGINE
Filtre huile	<b>35080</b>		<b>75519</b>	
Filtre gasoil	<b>13121</b>		<b>75485</b>	
Filtre air	<b>35426</b>			
Filtre direction	<b>17592</b>	<b>75642</b>	<b>75512</b>	

MODÈLE O550 INTEGRO MOTEUR OM441LA 340 CV - 01/97 - 09/02, EURO 1, 2				
DÉSIGNATION	MANN	DONALDSON	FLEETGUARD	FILTRE ORIGINE
Filtre huile	<b>35083</b>		<b>75564</b>	
Filtre gasoil	<b>35193</b>			
Filtre air	<b>35427</b>	<b>77304</b>		
Filtre direction	<b>17592</b>	<b>75642</b>	<b>75512</b>	

MODÈLE O550 INTEGRO MOTEUR OM457HLA 354 CV - 09/02 - 03/06 EURO 3				
DÉSIGNATION	MANN	DONALDSON	FLEETGUARD	FILTRE ORIGINE
Filtre huile	<b>37784</b>		<b>75529</b>	
Filtre gasoil	<b>38058</b>		<b>75493</b>	
Filtre air	<b>36614</b>		<b>75459</b>	
Filtre direction	<b>17592</b>	<b>75642</b>	<b>75512</b>	
Filtre séparateur d'eau parker racor	<b>54292</b>		<b>75508</b>	
Filtre séparateur d'eau parker racor R90P	<b>56486</b>	<b>75675</b>	<b>75504</b>	

MODÈLE INTEGRO NEW CHÂSSIS 633 001/002 MOTEUR OM926LA 285 CV - EURO 4, 5				
DÉSIGNATION	MANN	DONALDSON	FLEETGUARD	FILTRE ORIGINE
Filtre huile	<b>37784</b>		<b>75529</b>	
Filtre gasoil	<b>36820</b>		<b>75492</b>	
Filtre air	<b>36614</b>		<b>75459</b>	
Filtre direction	<b>17592</b>	<b>75642</b>	<b>75512</b>	
Filtre ad blue	<b>71482</b>			
Filtre séparateur d'eau	<b>54292</b>		<b>75508</b>	
Filtre webasto	<b>35193</b>			

MODÈLE INTEGRO NEW CHÂSSIS 633 001/002 MOTEUR OM457HLA 354 CV - EURO 4, 5				
DÉSIGNATION	MANN	DONALDSON	FLEETGUARD	FILTRE ORIGINE
Filtre huile	<b>37784</b>		<b>75529</b>	
Filtre gasoil	<b>38058</b>		<b>75493</b>	
Filtre air	<b>36614</b>		<b>75459</b>	
Filtre direction	<b>17592</b>	<b>75642</b>	<b>75512</b>	
Filtre ad blue	<b>71482</b>			
Filtre séparateur d'eau	<b>54292</b>		<b>75508</b>	
Filtre webasto	<b>35193</b>			

MODÈLE INTOURO 0560 MOTEUR OM926LA 285 CV - DEP 2007 EURO 4, 5				
DÉSIGNATION	MANN	DONALDSON	FLEETGUARD	FILTRE ORIGINE
Filtre huile	<b>37784</b>		<b>75529</b>	
Filtre gasoil	<b>36820</b>		<b>75492</b>	
Filtre air euro 4 Jsq 12/2009	<b>55187</b>	<b>74727</b>	<b>75454</b>	
Filtre air euro 5 Dep 01/2010			<b>74729</b>	
Préfiltre à gasoil	<b>60429</b>			
Filtre direction	<b>17592</b>	<b>75642</b>	<b>75512</b>	
Filtre ad blue	<b>71482</b>			
Filtre séparateur d'eau	<b>54292</b>		<b>75508</b>	
Filtre webasto	<b>35193</b>			

MODÈLE INTOURO 0560 MOTEUR OM936LA EURO 6 - DEP 2015				
DÉSIGNATION	MANN	DONALDSON	FLEETGUARD	FILTRE ORIGINE
Filtre huile	<b>93580</b>			
Filtre gasoil secondaire	<b>92850</b>			
Filtre séparateur	<b>94289</b>		<b>93575</b>	
Filtre à air		<b>94423</b>		<b>94301</b>
Filtre de direction	<b>92853</b>			



### Evobus

#### MODÈLE 0580 TRAVEGO 15RH, RHD MOTEUR OM457LA 354, 408 CV - DEP 11/99 EURO 3

DÉSIGNATION	MANN	DONALDSON	FLEETGUARD	FILTRE ORIGINE
Filtre huile	<b>35080</b>		<b>75519</b>	
Filtre gasoil	<b>38058</b>		<b>75493</b>	
Filtre air jsq 09/02	<b>35976</b>			
Filtre air dep 09/02	<b>53243</b>	<b>74726</b>		
Filtre séparateur d'eau	<b>54292</b>		<b>75508</b>	
Filtre direction	<b>17592</b>	<b>75642</b>	<b>75512</b>	

#### MODÈLE 0580 TRAVEGO 15RH, RHD MOTEUR OM502LA 476 CV - DEP 11/99 EURO 3

DÉSIGNATION	MANN	DONALDSON	FLEETGUARD	FILTRE ORIGINE
Filtre huile	<b>45273</b>			
Filtre gasoil	<b>38058</b>		<b>75493</b>	
Filtre air jsq 09/02	<b>35976</b>			
Filtre air dep 09/02	<b>53243</b>	<b>74726</b>		
Filtre séparateur d'eau	<b>54292</b>		<b>75508</b>	

#### MODÈLE 0814, 0815 VARIO, VEHIXEL, MAGO, MEDIANO MOTEUR OM904LA 136, 152 CV - DEP 10/96

DÉSIGNATION	MANN	DONALDSON	FLEETGUARD	FILTRE ORIGINE
Filtre huile	<b>36962</b>		<b>77333</b>	
Filtre gasoil	<b>36820</b>		<b>75492</b>	
Filtre air	<b>17552</b>			

#### MODÈLE SPRINTER CDI 208, 308, 408 CDI 211, 311, 411 CDI - 213, 313, 413 CDI MOTEUR OM611LA 82, 109, 129 CV - 04/00 - 05/06

DÉSIGNATION	MANN	DONALDSON	FLEETGUARD	FILTRE ORIGINE
Filtre huile	<b>38419</b>			
Filtre gasoil avec sonde capteur d'eau	<b>52521</b>		<b>75499</b>	
Filtre gasoil sans sonde capteur d'eau	<b>40285</b>			
Filtre air	<b>35077</b>			

#### MODÈLE SPRINTER 216, 316, 416 CDI MOTEUR OM612 156 CV - 04/00 - 05/06

DÉSIGNATION	MANN	DONALDSON	FLEETGUARD	FILTRE ORIGINE
Filtre huile	<b>38419</b>			
Filtre gasoil avec branchement pour évacuation d'eau jsq 12/2003	<b>53847</b>			
Filtre gasoil (simple)	<b>40285</b>			
Filtre gasoil avec capteur d'eau dep 01/2004	<b>58065</b>		<b>75500</b>	
Filtre air	<b>35077</b>			

#### MODÈLE SPRINTER 209, 309, 409 CDI 211, 311, 411 CDI - 213, 313, 413 CDI 215, 315, 415, 515 CDI MOTEUR OM646DELA 88, 109, 129, 150 CV - DEP 06/06

DÉSIGNATION	MANN	DONALDSON	FLEETGUARD	FILTRE ORIGINE
Filtre huile	<b>38419</b>			
Filtre gasoil sans capteur d'eau	<b>62941</b>		<b>75557</b>	
Filtre gasoil avec capteur d'eau	<b>58065</b>		<b>75500</b>	
Filtre air	<b>61930</b>		<b>75460</b>	
Filtre habitacle	<b>58066</b>			

#### MODÈLE SPRINTER / TRANSFER 410, 413, 416 CDI, 510, 513, 516 CDI MOTEUR OM651LA 95, 129, 163 CV - DEP 05/09

DÉSIGNATION	MANN	DONALDSON	FLEETGUARD	FILTRE ORIGINE
Filtre huile	<b>77095</b>			
Filtre gasoil version Mann	<b>69729</b>			
Filtre gasoil version Mahle	<b>82128</b>			
Filtre à air	<b>61930</b>			
Filtre habitacle	<b>58066</b>			



## Evobus

MODÈLE SPRINTER 218, 318, 418, 518 CDI MOTEUR OM642DELA 184 CV - DEP 06/06 JSQ 05/09				
DÉSIGNATION	MANN	DONALDSON	FLEETGUARD	FILTRE ORIGINE
Filtre huile	<b>61936</b>			
Filtre gasoil sans capteur d'eau	<b>62941</b>		<b>75557</b>	
Filtre gasoil avec capteur d'eau	<b>58065</b>		<b>75500</b>	
Filtre air	<b>61930</b>		<b>75460</b>	
Filtre habitacle	<b>58066</b>			

MODÈLE SPRINTER 219, 319, 419, 519 CDI MOTEUR OM642LA 190 CV - DEP 05/09				
DÉSIGNATION	MANN	DONALDSON	FLEETGUARD	FILTRE ORIGINE
Filtre huile	<b>61936</b>			
Filtre gasoil version Mann	<b>69729</b>			
Filtre gasoil version Mahle	<b>82128</b>			
Filtre à air	<b>61930</b>			
Filtre habitacle	<b>58066</b>			

MODÈLE SETRA 215UL, SL MOTEUR OM447H 240 CV - 09/85 - 09/94				
DÉSIGNATION	MANN	DONALDSON	FLEETGUARD	FILTRE ORIGINE
Filtre huile	<b>35080</b>		<b>75519</b>	
Filtre gasoil	<b>13121</b>		<b>75485</b>	
Filtre air	<b>13226</b>	<b>75686</b>	<b>75446</b>	
Filtre direction	<b>17592</b>	<b>75642</b>	<b>75512</b>	

MODÈLE SETRA 215UL, SL MOTEUR MAN D2866UH 240 CV - 09/85 - 09/94				
DÉSIGNATION	MANN	DONALDSON	FLEETGUARD	FILTRE ORIGINE
Filtre huile	<b>58226</b>			
Filtre gasoil	<b>13226</b>	<b>75686</b>	<b>75446</b>	
Filtre air	<b>35193</b>		<b>75505</b>	
Filtre direction	<b>17592</b>	<b>75642</b>	<b>75512</b>	

MODÈLE 215HRI, BR300 MOTEUR OM441LA 340 CV - 92 - 95				
DÉSIGNATION	MANN	DONALDSON	FLEETGUARD	FILTRE ORIGINE
Filtre huile	<b>35083</b>		<b>75564</b>	
Filtre gasoil	<b>13121</b>		<b>75485</b>	
Filtre air	<b>35076</b>			
Filtre direction	<b>17592</b>	<b>75642</b>	<b>75512</b>	

MODÈLE 250 SPECIAL MOTEUR MAN D2866LOH22 370 CV - 07/94 - 09/97				
DÉSIGNATION	MANN	DONALDSON	FLEETGUARD	FILTRE ORIGINE
Filtre huile	<b>58226</b>			
Filtre gasoil	<b>35193</b>		<b>75505</b>	
Filtre air	<b>35076</b>			
Filtre direction	<b>17592</b>	<b>75642</b>	<b>75512</b>	

MODÈLE 313-315UL MOTEUR OM447HLA 250 CV - 04/95 - 08/00 EURO 0, 1, 2				
DÉSIGNATION	MANN	DONALDSON	FLEETGUARD	FILTRE ORIGINE
Filtre huile	<b>35080</b>		<b>75519</b>	
Filtre gasoil	<b>35193</b>		<b>75505</b>	
Filtre air	<b>35076</b>			
Filtre direction	<b>17592</b>	<b>75642</b>	<b>75512</b>	

MODÈLE 313-315UL MOTEUR OM457HLA 250 CV - 09/00 - 01/06 EURO 3				
DÉSIGNATION	MANN	DONALDSON	FLEETGUARD	FILTRE ORIGINE
Filtre huile	<b>37784</b>			
Filtre gasoil	<b>38058</b>		<b>75493</b>	
Filtre air	<b>36614</b>		<b>75459</b>	
Filtre cartouche séparateur d'eau parker	<b>54292</b>		<b>75508</b>	
Filtre direction	<b>17592</b>	<b>75642</b>	<b>75512</b>	

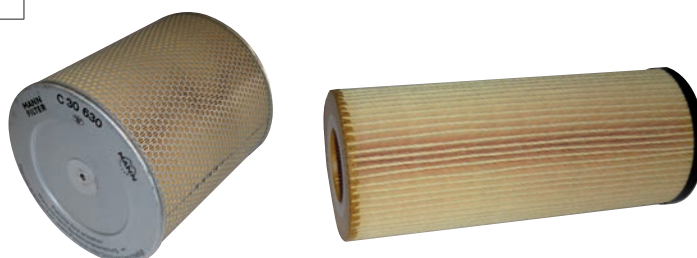

### Evobus

#### MODÈLE S309HD, S312HD MOTEUR OM441LA 340 CV - 09/92 - 99

DÉSIGNATION	MANN	DONALDSON	FLEETGUARD	FILTRE ORIGINE
Filtre huile	<b>35083</b>		<b>75564</b>	
Filtre gasoil	<b>13121</b>		<b>75485</b>	
Filtre air	<b>35074</b>	<b>77308</b>		
Filtre direction	<b>17592</b>	<b>75642</b>	<b>75512</b>	

#### MODÈLE S315HD, HDH MOTEUR OM442LA 381 CV - 09/91 - 2000

DÉSIGNATION	MANN	DONALDSON	FLEETGUARD	FILTRE ORIGINE
Filtre huile	<b>35080</b>		<b>75519</b>	
Filtre gasoil	<b>13121</b>		<b>75485</b>	
Filtre air jsq 12/96	<b>35076</b>			
Filtre air jsq dep 01/97	<b>35427</b>	<b>77304</b>		
Filtre direction	<b>17592</b>	<b>75642</b>	<b>75512</b>	

#### MODÈLE S312-315H, GT, GTHD MOTEUR OM457LA 354-422 CV - 09/00 - 09/04 EURO 3

DÉSIGNATION	MANN	DONALDSON	FLEETGUARD	FILTRE ORIGINE
Filtre huile	<b>53245</b>			
Filtre gasoil	<b>38058</b>		<b>75493</b>	
Filtre séparateur d'eau	<b>54292</b>		<b>75508</b>	
Filtre air 5 par véhicule	<b>53243</b>	<b>74726</b>		
Filtre direction	<b>17592</b>	<b>75642</b>	<b>75512</b>	

#### MODÈLE S315NF S319NF MOTEUR OM447HLA 250-300 CV - 05/96 - 09/00 EURO 1, 2

DÉSIGNATION	MANN	DONALDSON	FLEETGUARD	FILTRE ORIGINE
Filtre huile	<b>35080</b>		<b>75519</b>	
Filtre gasoil	<b>35193</b>		<b>75505</b>	
Filtre air	<b>35426</b>			
Filtre boîte de vitesse HP500/590	<b>51467</b>	<b>75684</b>	<b>75514</b>	<b>56339</b>
Filtre direction	<b>17592</b>	<b>75642</b>	<b>75512</b>	

#### MODÈLE S315NF S319NF MOTEUR OM457HLA 252 CV - 09/00 - 2007 EURO 3

DÉSIGNATION	MANN	DONALDSON	FLEETGUARD	FILTRE ORIGINE
Filtre huile	<b>53245</b>			
Filtre gasoil	<b>38058</b>		<b>75493</b>	
Filtre séparateur d'eau parker racor system	<b>54292</b>		<b>75508</b>	
Filtre séparateur d'eau parker racor system R90P	<b>56486</b>	<b>75675</b>	<b>75504</b>	
Filtre air	<b>36614</b>		<b>75459</b>	
Filtre boîte de vitesse HP500/590	<b>51467</b>	<b>75684</b>	<b>75514</b>	<b>56339</b>
Filtre direction	<b>17592</b>	<b>75642</b>	<b>75512</b>	



## Evobus

### MODÈLE S412-415UL, S417UL-419UL MOTEUR OM457HLA 299-353 CV - DEP 01/06 EURO 4

DÉSIGNATION	MANN	DONALDSON	FLEETGUARD	FILTRE ORIGINE
Filtre huile	<b>37784</b>			
Filtre gasoil	<b>38058</b>		<b>75493</b>	
Filtre séparateur d'eau	<b>54292</b>		<b>75508</b>	
Filtre air	<b>36614</b>		<b>75459</b>	
Filtre direction	<b>17592</b>	<b>75642</b>	<b>75512</b>	

### MODÈLE S417-419UL MOTEUR OM470LA EURO 6 DEP 09/13

DÉSIGNATION	MANN	DONALDSON	FLEETGUARD	FILTRE ORIGINE
Filtre huile				<b>94327</b>
Filtre gasoil				<b>94326</b>
Filtre air		<b>92219</b>		
Filtre séparateur d'eau	<b>94289</b>			
Filtre de direction	<b>92853</b>			
Filtre air compresseur	<b>51322</b>			
Filtre ad blue				<b>94328</b>

### MODÈLE S415-416LE MOTEUR OM936LA EURO 6

DÉSIGNATION	MANN	DONALDSON	FLEETGUARD	MAHL	FILTRE ORIGINE
Filtre huile				<b>94781</b>	<b>94329</b>
Filtre gasoil	<b>92850</b>				
Filtre air		<b>94423</b>			<b>94301</b>
Filtre de direction	<b>17592</b>	<b>75642</b>	<b>75512</b>		

### MODÈLE S415GTHD, S416GTHD, S415HD, HDH TOP CLASS, CONFORT CLASS MOTEUR OM457LA 354 CV - DEP 03/01 EURO 3, 4

DÉSIGNATION	MANN	DONALDSON	FLEETGUARD	FILTRE ORIGINE
Filtre huile	<b>53245</b>			
Filtre gasoil	<b>38058</b>		<b>75493</b>	
Filtre séparateur d'eau	<b>54292</b>		<b>75508</b>	
Filtre air 5 par véhicule	<b>53243</b>	<b>74726</b>		
Filtre direction	<b>17592</b>	<b>75642</b>	<b>75512</b>	

### MODÈLE S415, 416, 417GTHD MOTEUR OM457LA DEP 04/2010 EURO 5 EEV

DÉSIGNATION	MANN	DONALDSON	FLEETGUARD	FILTRE ORIGINE
Filtre huile	<b>53245</b>			
Filtre gasoil	<b>38058</b>		<b>75493</b>	
Filtre séparateur d'eau	<b>54292</b>		<b>75508</b>	
Filtre air	<b>67031</b>	<b>74729</b>		
Filtre webasto	<b>35193</b>		<b>75505</b>	
Filtre direction	<b>17592</b>	<b>75642</b>	<b>75512</b>	
Filtre ad blue	<b>71482</b>			

### MODÈLE S411HD TOP CLASS MOTEUR OM501LA 354 CV - 09/01 - 09/04 EURO 3

DÉSIGNATION	MANN	DONALDSON	FLEETGUARD	FILTRE ORIGINE
Filtre huile	<b>45273</b>			
Filtre gasoil	<b>38058</b>		<b>75493</b>	
Filtre séparateur d'eau	<b>54292</b>		<b>75508</b>	
Filtre air 5 par véhicule	<b>53243</b>	<b>74726</b>		
Filtre direction	<b>17592</b>	<b>75642</b>	<b>75512</b>	
Filtre ventilation carter moteur	<b>57816</b>			

### MODÈLE S415HD, HDH S416, 417HD MOTEUR OM502LA 435, 477 CV - DEP 03/01 EURO 3

DÉSIGNATION	MANN	DONALDSON	FLEETGUARD	FILTRE ORIGINE
Filtre huile	<b>45273</b>			
Filtre gasoil	<b>38058</b>		<b>75493</b>	
Filtre séparateur d'eau	<b>54292</b>		<b>75508</b>	
Filtre air 5 par véhicule	<b>53243</b>	<b>74726</b>		
Filtre direction	<b>17592</b>	<b>75642</b>	<b>75512</b>	
Filtre ventilation carter moteur	<b>57816</b>			



## Evobus

### MODÈLE S415NF, S416NF MOTEUR OM457HLA 299 CV - DEP 09/06

DÉSIGNATION	MANN	DONALDSON	FLEETGUARD	FILTRE ORIGINE
Filtre huile	<b>53245</b>			
Filtre gasoil	<b>38058</b>		<b>75493</b>	
Filtre séparateur d'eau	<b>54292</b>		<b>75508</b>	
Filtre air	<b>42318</b>		<b>75462</b>	
Filtre direction	<b>17592</b>	<b>75642</b>	<b>75512</b>	
Filtre de boîte ZF (6HP592, 6HP502C, 6HP602C)	<b>51467</b>	<b>75684</b>	<b>75514</b>	<b>56339</b>

### MODÈLE S511-516 HD12, HD13, HD, FMD COMFORT CLASS 500, TOP CLASS MOTEUR OM470LA EURO 6

DÉSIGNATION	MANN	DONALDSON	FLEETGUARD	MAHL	FILTRE ORIGINE
Filtre à huile				<b>94781</b>	
Filtre à air					
Filtre + Préfiltre gasoil					
Filtre gasoil seul					
Préfiltre seul					
Séparateur d'eau	<b>94289</b>				

### MODÈLE S515-517 HDH COMFORT CLASS 500 MOTEUR OM471LA 476/510 CV - EURO 6 DEP 2014

DÉSIGNATION	MANN	DONALDSON	FLEETGUARD	FILTRE ORIGINE
Filtre à huile	<b>94313</b>			
Filtre à gasoil				<b>94325</b>
Filtre à air				
Filtre + Préfiltre gasoil				
Filtre AD Blue				



## Fast

### MODÈLE FAST SCOLER 1 MOTEUR 060226W 210 CV - EURO 0, 1

DÉSIGNATION	MANN	DONALDSON	FLEETGUARD	FILTRE ORIGINE
Filtre huile	<b>17737</b>	<b>75677</b>	<b>75521</b>	
Filtre gasoil	<b>35087</b>	<b>81380</b>	<b>75488</b>	<b>72640</b>
Filtre air	<b>37700</b>		<b>76662</b>	
Filtre direction	<b>17592</b>	<b>75642</b>	<b>75512</b>	

### MODÈLE FAST SCOLER 2 MOTEUR 060226W4 EURO 2

DÉSIGNATION	MANN	DONALDSON	FLEETGUARD	FILTRE ORIGINE
Filtre huile	<b>17737</b>	<b>75677</b>	<b>75521</b>	
Filtre gasoil	<b>35087</b>	<b>81380</b>	<b>75488</b>	<b>72640</b>
Filtre air	<b>37700</b>		<b>76662</b>	
Filtre direction	<b>17592</b>	<b>75642</b>	<b>75512</b>	

### MODÈLE FAST JUMBO, FAST SCOLER 2 EURO 3 MOTEUR DCI 6W501 265 CV - EURO 3

DÉSIGNATION	MANN	DONALDSON	FLEETGUARD	FILTRE ORIGINE
Filtre huile	<b>17737</b>	<b>75677</b>	<b>75521</b>	
Filtre gasoil	<b>37456</b>		<b>75496</b>	
Filtre air	<b>39943</b>	<b>74728</b>	<b>75450</b>	
Filtre air securite	<b>63078</b>		<b>75451</b>	

### MODÈLE FAST SCOLER 3 MOTEUR MAN D0836LOH03 220, 280 CV - EURO 3

DÉSIGNATION	MANN	DONALDSON	FLEETGUARD	FILTRE ORIGINE
Filtre huile	<b>17750</b>		<b>75523</b>	
Filtre gasoil	<b>35193</b>		<b>75505</b>	
Filtre air	<b>35076</b>			
Filtre direction	<b>17592</b>	<b>75642</b>	<b>75512</b>	

### MODÈLE FAST SCOLER 3 MOTEUR MAN D0836LOH51-58/62/63 280 CV - EURO 4

DÉSIGNATION	MANN	DONALDSON	FLEETGUARD	FILTRE ORIGINE
Filtre huile	<b>17750</b>		<b>75523</b>	
Filtre gasoil	<b>55269</b>			
Filtre air	<b>57264</b>			

## Fast

MODÈLE FAST SCOLER 3 MOTEUR D2066LUH EURO 4				
DÉSIGNATION	MANN	DONALDSON	FLEETGUARD	FILTRE ORIGINE
Filtre huile	<b>55271</b>		<b>75516</b>	
Filtre gasoil	<b>55269</b>			
Filtre air	<b>57463</b>	<b>75703</b>	<b>75461</b>	
Filtre hydraulique ventilateur	<b>64079</b>	<b>75627</b>		
Filtre direction	<b>17592</b>	<b>75642</b>	<b>75512</b>	

MODÈLE FAST SCOLER 4, 5 MOTEUR DX17 265 CV - EURO 5				
DÉSIGNATION	MANN	DONALDSON	FLEETGUARD	FILTRE ORIGINE
Filtre huile	<b>65338</b>		<b>75937</b>	
Préfiltre gasoil	<b>66662</b>		<b>75938</b>	
Filtre séparateur d'eau	<b>62364</b>		<b>77089</b>	
Filtre gasoil	<b>65337</b>		<b>75935</b>	
Filtre à air	<b>70418</b>	<b>75377</b>	<b>75936</b>	
Filtre AD Blue	<b>72863</b>			

MODÈLE FAST SYTER MOTEUR MAN D2866LOH35 260, 310 CV- EURO 3				
DÉSIGNATION	MANN	DONALDSON	FLEETGUARD	FILTRE ORIGINE
Filtre huile	<b>38386</b>			
Filtre gasoil	<b>35193</b>		<b>75505</b>	
Filtre air	<b>35076</b>			
Filtre direction	<b>17592</b>	<b>75642</b>	<b>75512</b>	

MODÈLE FAST STYLUS MOTEUR MAN D0826LOH15 220 CV - EURO 2				
DÉSIGNATION	MANN	DONALDSON	FLEETGUARD	FILTRE ORIGINE
Filtre huile	<b>17750</b>		<b>75523</b>	
Filtre gasoil	<b>35193</b>		<b>75505</b>	
Filtre air H378 Ø ext 243 (plusieurs montages)	<b>38439</b>		<b>75470</b>	
Filtre direction	<b>17592</b>	<b>75642</b>	<b>75512</b>	

## Fast

MODÈLE FAST STARTER L, LE (A69) MOTEUR D0836LOH64 291 CV - EURO 5				
DÉSIGNATION	MANN	DONALDSON	FLEETGUARD	FILTRE ORIGINE
Filtre huile	<b>17750</b>			
Préfiltre gasoil	<b>55269</b>		<b>75498</b>	
Filtre à air	<b>57264</b>	<b>75079</b>		

MODÈLE FAST STARTER L, LE (A69), S (A91) MOTEUR D0836LOH EURO 6 DEP 01/14				
DÉSIGNATION	MANN	DONALDSON	FLEETGUARD	FILTRE ORIGINE
Filtre huile	<b>17750</b>			
Filtre gasoil	<b>55269</b>		<b>75498</b>	
Filtre air	<b>57264</b>	<b>75079</b>		
Filtre direction	<b>17592</b>	<b>75642</b>	<b>75512</b>	
Filtre ad blue	<b>84960</b>			

MODÈLE FAST STARTER L, LE (A69), S (A91) MOTEUR D2066LOH 320 CV - EURO 6 DEP 01/14				
DÉSIGNATION	MANN	DONALDSON	FLEETGUARD	FILTRE ORIGINE
Filtre huile	<b>55271</b>		<b>75516</b>	
Filtre gasoil	<b>55269</b>		<b>75498</b>	
Filtre air	<b>57264</b>	<b>75079</b>		
Filtre direction	<b>17592</b>	<b>75642</b>	<b>75512</b>	
Filtre ad blue	<b>84960</b>			

## Irisbus, Iveco

MODÈLE IRISBUS IVECO DAILY MOTEUR 3,0DHPI F1CE0481B CV 136 - DEP 09/04 JSQ 07/06				
DÉSIGNATION	MANN	DONALDSON	FLEETGUARD	FILTRE ORIGINE
Filtre huile	<b>54839</b>			
Filtre gasoil	<b>64724</b>			
Filtre air	<b>43168</b>		<b>75452</b>	



### Irisbus, Iveco

#### MODÈLE IRISBUS IVECO DAILY - MOTEUR F1CE3481CC, F1CE3481LC, 50C17, 65C17 140, 170 CV - DEP 09/09

DÉSIGNATION	MANN	DONALDSON	FLEETGUARD	FILTRE ORIGINE
Filtre huile	<b>65645</b>		<b>75560</b>	<b>60371</b>
Filtre gasoil système UFI	<b>64724</b>			
Filtre air	<b>43168</b>		<b>75452</b>	
Filtre habitacle	<b>68221</b>			

#### MODÈLE IRISBUS IVECO MAGO 1 CHÂSSIS 59-12 MOTEUR 8140-47

DÉSIGNATION	MANN	DONALDSON	FLEETGUARD	FILTRE ORIGINE
Filtre huile	<b>35474</b>		<b>75522</b>	
Filtre gasoil	<b>35090</b>		<b>75487</b>	
Filtre air	<b>35475</b>			

#### MODÈLE IRISBUS IVECO MAGO 2 CHÂSSIS 65C18 MOTEUR F1CE0481HA 176 CV

DÉSIGNATION	MANN	DONALDSON	FLEETGUARD	FILTRE ORIGINE
Filtre huile	<b>65645</b>		<b>75560</b>	<b>60371</b>
Filtre gasoil système UFI	<b>64724</b>			
Filtre air	<b>43168</b>		<b>75452</b>	

#### MODÈLE IRISBUS MIDYS MOTEUR TECTOR F4A 209 CV - EURO 3 09/04 - 02/06

DÉSIGNATION	MANN	DONALDSON	FLEETGUARD	UFI	FILTRE ORIGINE
Filtre huile	<b>54300</b>		<b>74945</b>	<b>75624</b>	<b>44858</b>
Filtre air	<b>68458</b>				
Filtre gasoil	<b>53719</b>		<b>74926</b>	<b>75623</b>	<b>44859</b>
Filtre reniflard	<b>53717</b>		<b>75473</b>		<b>56528</b>
Filtre direction	<b>17592</b>	<b>75642</b>	<b>75512</b>		

#### MODÈLE IRISBUS EUROSCHOOL VEHIXEL MOTEUR TECTOR F4AE

DÉSIGNATION	MANN	DONALDSON	FLEETGUARD	UFI	FILTRE ORIGINE
Filtre à air	<b>60112</b>				

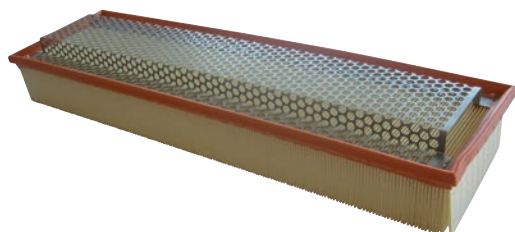

### Irisbus, Iveco

#### MODÈLE IRISBUS HEULIEZ GX77 MOTEUR MIDS 060212B 159 CV - DEP 01/90

DÉSIGNATION	MANN	DONALDSON	FLEETGUARD	UFI	FILTRE ORIGINE
Filtre huile	<b>17737</b>	<b>75677</b>	<b>75521</b>		
Filtre gasoil	<b>35087</b>	<b>81380</b>	<b>75488</b>	<b>94311</b>	<b>72640</b>
Filtre air	<b>48125</b>	<b>75698</b>	<b>75458</b>		

#### MODÈLE IRISBUS HEULIEZ GX117 MOTEUR TECTOR 209 CV - DEP 05/02 EURO 3

DÉSIGNATION	MANN	DONALDSON	FLEETGUARD	UFI	FILTRE ORIGINE
Filtre huile	<b>54300</b>		<b>74945</b>	<b>75624</b>	<b>44858</b>
Filtre gasoil	<b>53719</b>		<b>74926</b>	<b>75623</b>	<b>44859</b>
Préfiltre gasoil	<b>37681</b>	<b>75662</b>	<b>75503</b>	<b>75622</b>	<b>44202</b>
Filtre air	<b>48125</b>	<b>75698</b>	<b>75458</b>		
Filtre direction	<b>17592</b>	<b>75642</b>	<b>75512</b>		
Filtre boîte de vitesse Allison			<b>75558</b>		<b>70815</b>

#### MODÈLE IRISBUS HEULIEZ GX127, 127L MOTEUR TECTOR F4A 218 CV - DEP 03/06 EURO 4

DÉSIGNATION	MANN	DONALDSON	FLEETGUARD	UFI	FILTRE ORIGINE
Filtre huile	<b>54300</b>		<b>74945</b>	<b>75624</b>	<b>44858</b>
Filtre gasoil	<b>53719</b>		<b>74926</b>	<b>75623</b>	<b>44859</b>
Filtre air	<b>51549</b>	<b>75616</b>	<b>75457</b>		<b>53452</b>
Préfiltre gasoil	<b>37681</b>	<b>75662</b>	<b>75503</b>	<b>75622</b>	<b>44202</b>
Filtre hydraulique ventilateur	<b>53891</b>		<b>75510</b>		
Filtre ad blue	<b>57929</b>	<b>75705</b>			<b>56579</b>
Filtre direction	<b>17592</b>	<b>75642</b>	<b>75512</b>		
Filtre boîte de vitesse allison			<b>75558</b>		<b>70815</b>

#### MODÈLE IRISBUS HEULIEZ GX317 MOTEUR MIDR 062045 DEP 09/95 JSQ 12/00 EURO 1,2

DÉSIGNATION	MANN	DONALDSON	FLEETGUARD	UFI	FILTRE ORIGINE
Filtre huile	<b>36273</b>		<b>75525</b>		
Filtre gasoil	<b>35087</b>	<b>81380</b>	<b>75488</b>	<b>94311</b>	<b>72640</b>
Filtre air	<b>35182</b>	<b>75690</b>	<b>75469</b>		
Filtre hydraulique ventilateur	<b>54153</b>				
Filtre boîte ZF HP 502	<b>51467</b>	<b>75684</b>	<b>75514</b>		<b>56339</b>
Filtre direction	<b>17592</b>	<b>75642</b>	<b>75512</b>		
Filtre dessiccateur	<b>36996</b>	<b>75695</b>	<b>75463</b>		<b>658</b>

## Irisbus, Iveco

MODÈLE IRISBUS HEULIEZ GX317 MOTEUR CURSOR F2B DEP 09/01 EURO 3					
DÉSIGNATION	MANN	DONALDSON	FLEETGUARD	UFI	FILTRE ORIGINE
Filtre huile	<b>42614</b>	<b>75613</b>	<b>75531</b>		<b>44854</b>
Filtre gasoil	<b>55407</b>	<b>81379</b>	<b>81288</b>		<b>53833</b>
Filtre à air jsq 12/2003	<b>35072</b>	<b>75628</b>	<b>75464</b>		
Filtre à air dep 12/2003	<b>51549</b>	<b>75616</b>	<b>75457</b>		<b>53452</b>
Filtre à air version moteur renault	<b>35182</b>	<b>75690</b>	<b>75469</b>		
Filtre reniflard 400 microns					<b>53032</b>
Joint de filtre (2 par véhicule)					<b>44851</b>
Filtre de turbo	<b>51548</b>	<b>81381</b>	<b>75455</b>	<b>75621</b>	<b>44853</b>
Filtre direction	<b>17592</b>	<b>75642</b>	<b>75512</b>		
Filtre boîte ZF HP500	<b>51467</b>	<b>75684</b>	<b>75514</b>		<b>56339</b>

MODÈLE IRISBUS HEULIEZ GX 217, 417 MOTEUR VOLVO DH10A DEP 08/96 JSQ 07/01					
DÉSIGNATION	MANN	DONALDSON	FLEETGUARD	UFI	FILTRE ORIGINE
Filtre huile	<b>17739</b>	<b>75679</b>	<b>75518</b>		
Filtre gasoil X 2	<b>35086</b>	<b>75676</b>	<b>75481</b>		
Filtre air	<b>17509</b>	<b>75691</b>	<b>75467</b>		
Filtre hydraulique ventilateur	<b>54153</b>		<b>75509</b>		
Filtre dessiccateur	<b>36996</b>	<b>75695</b>	<b>75463</b>		<b>658</b>

MODÈLE IRISBUS PROWAYS, PROXYS MOTEUR TECTOR 6 F4A 218 CV - EURO 5 DEP 07/08					
DÉSIGNATION	MANN	DONALDSON	FLEETGUARD	UFI	FILTRE ORIGINE
Filtre huile	<b>54300</b>		<b>74945</b>	<b>75624</b>	<b>44858</b>
Filtre gasoil	<b>53719</b>		<b>74926</b>	<b>75623</b>	<b>44859</b>
Filtre air	<b>51549</b>	<b>75616</b>	<b>75457</b>		<b>53452</b>
Préfiltre gasoil	<b>37681</b>	<b>75662</b>	<b>75503</b>	<b>75622</b>	<b>44202</b>
Filtre direction	<b>17592</b>	<b>75642</b>	<b>75512</b>		
Filtre reniflard	<b>53717</b>				<b>56528</b>
Filtre direction	<b>57929</b>	<b>75705</b>			<b>56579</b>



## Irisbus, Iveco

MODÈLE IRISBUS AGORA MOTEUR MIDR 062045 02/96 - 07/02					
DÉSIGNATION	MANN	DONALDSON	FLEETGUARD	UFI	FILTRE ORIGINE
Filtre huile	<b>36273</b>		<b>75525</b>		
Filtre gasoil	<b>35087</b>	<b>81380</b>	<b>75488</b>	<b>94311</b>	
Filtre air	<b>35182</b>	<b>75690</b>	<b>75469</b>		
Filtre direction	<b>17592</b>	<b>75642</b>	<b>75512</b>		
Filtre hydraulique ventilateur	<b>54153</b>		<b>75509</b>		
Filtre boîte de vitesse HP500	<b>51467</b>	<b>75684</b>	<b>75514</b>		<b>56339</b>

MODÈLE IRISBUS AGORA MOTEUR CURSOR 8 (F2B) 245, 290 CV - 01/02 - 03/06					
DÉSIGNATION	MANN	DONALDSON	FLEETGUARD	UFI	FILTRE ORIGINE
Filtre huile	<b>42614</b>	<b>75613</b>	<b>75531</b>		<b>44854</b>
Filtre gasoil	<b>37681</b>	<b>75662</b>	<b>75503</b>	<b>75622</b>	<b>44202</b>
Filtre air	<b>35426</b>	<b>75599</b>	<b>75453</b>		
Filtre turbo air	<b>51548</b>	<b>81381</b>	<b>75455</b>	<b>75621</b>	<b>44853</b>
Filtre hydraulique ventilateur	<b>54153</b>		<b>75509</b>		
Filtre boîte ZF HP500/502	<b>51467</b>	<b>75684</b>	<b>75514</b>		<b>56339</b>
Filtre reniflard 400 micron					<b>53032</b>
Joint filtre reniflard					<b>44851</b>

MODÈLE IRISBUS CITELIS MOTEUR CURSOR 8 245 CV - EURO 4/5 EEV DEP 09/06					
DÉSIGNATION	MANN	DONALDSON	FLEETGUARD	UFI	FILTRE ORIGINE
Filtre huile	<b>42614</b>	<b>75613</b>	<b>75531</b>		<b>44854</b>
Préfiltre gasoil	<b>54302</b>			<b>75712</b>	<b>53406</b>
Filtre gasoil	<b>68305</b>				<b>56656</b>
Filtre air	<b>51549</b>	<b>75616</b>	<b>75457</b>		<b>53452</b>
Filtre air module doseur	<b>63522</b>		<b>74928</b>		<b>72641</b>
Filtre turbo air	<b>51548</b>	<b>81381</b>	<b>75455</b>	<b>75621</b>	<b>44853</b>
Filtre ad blue	<b>57929</b>	<b>75705</b>			<b>56579</b>
Filtre direction	<b>17592</b>	<b>75642</b>	<b>75512</b>		
Filtre hydraulique ventilateur	<b>53891</b>		<b>75510</b>		
Filtre boîte de vitesse HP500/592	<b>51467</b>	<b>75684</b>	<b>75514</b>		<b>56339</b>
Filtre webasto	<b>35087</b>	<b>81380</b>	<b>75488</b>		<b>72640</b>

### Irisbus, Iveco

MODÈLE IRISBUS CITELIS MOTEUR CURSOR 8 330, 380 CV - EURO 4/5 EEV DEP 09/06					
DÉSIGNATION	MANN	DONALDSON	FLEETGUARD	UFI	FILTRE ORIGINE
Filtre huile	42614	75613	75531		44854
Préfiltre gasoil	54302	75672	75507	75712	53406
Filtre gasoil	68305				56656
Filtre air module doseur	48125	75698	75458		
Filtre turbo air	51548	81381	75455	75621	44853
Filtre ad blue	57929	75705			56579
Filtre direction	17592	75642	75512		
Filtre hydraulique ventilateur	53891		75510		
Filtre boîte de vitesse HP500/592	51467	75684	75514		56339

MODÈLE IVECO URBANWAY MOTEUR TECTOR 7 286 CV - EURO 6 DEP 05/13					
DÉSIGNATION	MANN	DONALDSON	FLEETGUARD	UFI	FILTRE ORIGINE
Filtre huile	54300		74945	75624	44858
Filtre gasoil					94300
Filtre air (grand)					94352
Filtre air (petit)	94349				
Filtre hydraulique ventilateur					85088
Filtre séparateur d'eau	62364				94302
Filtre ad blue			94317		

MODÈLE IRISBUS TRACER MOTEUR MIHS0622045A 253 CV - JSQ 05/93					
DÉSIGNATION	MANN	DONALDSON	FLEETGUARD	UFI	FILTRE ORIGINE
Filtre huile	17882		75520		
Filtre gasoil	35087	81380	75488		72640
Filtre air	36116				

MODÈLE IRISBUS TRACER MOTEUR MIHR0622045 253 CV - DEP 05/93					
DÉSIGNATION	MANN	DONALDSON	FLEETGUARD	UFI	FILTRE ORIGINE
Filtre huile	17737	75677	75521		
Filtre gasoil dep 12/97	35087	81380	75488	94311	72640
Filtre air	35182	75690	75469		
Filtre hydraulique ventilateur dep 05/95	54153		75509		

### Irisbus, Iveco

MODÈLE RECREO EURO 2 MOTEUR MIHR062045A41 256 CV - JSQ 07/01					
DÉSIGNATION	MANN	DONALDSON	FLEETGUARD	UFI	FILTRE ORIGINE
Filtre huile	17737	75677	75521		
Filtre gasoil primaire PH4	38198				
Filtre gasoil filtre fin PJ4	38199				
Filtre air	35182	75690	75469		
Filtre ventilateur					66722

MODÈLE RECREO EURO 3, AXER EURO 3 MOTEUR CURSOR F2B 310 CV - DEP 07/01					
DÉSIGNATION	MANN	DONALDSON	FLEETGUARD	UFI	FILTRE ORIGINE
Filtre huile	42614	75613	75531		44854
Filtre de turbo air	51548	81381	75455	75621	44853
Filtre reniflard 400 micron					53032
Joint filtre reniflard					44851
Filtre séparateur d'eau	57401		74940		51959
Filtre air	35426	75599	75453		
Filtre direction	17592	75642	75512		
Filtre gasoil	37681	75662	75503		44202
Filtre hydraulique ventilateur	54153		75509		

MODÈLE RECREO, CROSSWAY MOTEUR TECTOR 6 264, 299 CV - DEP 09/06 EURO 4					
DÉSIGNATION	MANN	DONALDSON	FLEETGUARD	UFI	FILTRE ORIGINE
Filtre huile	54300		74945	75624	44858
Filtre gasoil	35087	81380	75488	94311	72640
Préfiltre gasoil	54302	75672	75507	75712	53406
Filtre air	57463	75703	75461		
Filtre air module doseur	63522		74928		72641
Filtre ad blue	57929	75705			56579
Filtre hydraulique ventilateur	54153		75509		
Filtre webasto	62118		77088		
Filtre direction	17592	75642	75512		
Filtre reniflard	53717				56528



## Irisbus, Iveco

MODÈLE RECREO, CROSSWAY MOTEUR TECTOR 6 264 CV - EURO 5 DEP 07/2012					
DÉSIGNATION	MANN	DONALDSON	FLEETGUARD	UFI	FILTRE ORIGINE
Filtre huile	<b>54300</b>		<b>74945</b>	<b>75624</b>	<b>44858</b>
Filtre gasoil	<b>53719</b>		<b>74926</b>	<b>75623</b>	<b>44859</b>
Préfiltre gasoil	<b>54302</b>		<b>75507</b>		<b>53406</b>
Filtre à air	<b>74173</b>				
Filtre hydraulique ventilateur	<b>54153</b>				
Filtre direction	<b>17592</b>	<b>75642</b>	<b>75512</b>		
Filtre denoxtronic 1	<b>57929</b>				
Filtre denoxtronic 2	<b>72863</b>				
Boîte ZF 6S	<b>51467</b>				
Boîte voith S854-5	<b>82123</b>				

MODÈLE CROSSWAY MOTEUR TECTOR 7 286/320 CV - EURO 6 DEP 09/13					
DÉSIGNATION	MANN	DONALDSON	FLEETGUARD	UFI	FILTRE ORIGINE
Filtre huile	<b>54300</b>		<b>74945</b>	<b>75624</b>	<b>44858</b>
Filtre gasoil			<b>75804</b>		<b>94300</b>
Filtre air	<b>36614</b>	<b>75615</b>			
Filtre hydraulique ventilateur					<b>85088</b>
Filtre séparateur d'eau	<b>62364</b>				<b>94302</b>
Filtre ad blue			<b>94317</b>		
Filtre webasto					<b>94311</b>

MODÈLE RECREO, CROSSWAY MOTEUR CURSOR 8 330 CV - DEP 07/06 EURO 4, 5					
DÉSIGNATION	MANN	DONALDSON	FLEETGUARD	UFI	FILTRE ORIGINE
Filtre huile	<b>42614</b>	<b>75613</b>	<b>75531</b>		<b>44854</b>
Filtre de turbo air	<b>51548</b>	<b>81381</b>	<b>75455</b>	<b>75621</b>	<b>44853</b>
Filtre reniflard 400 micron					<b>53032</b>
Joint filtre reniflard (2 par filtre)					<b>44851</b>
Préfiltre gasoil	<b>57401</b>		<b>74940</b>		<b>51959</b>
Filtre gasoil	<b>37681</b>	<b>75662</b>	<b>75503</b>	<b>75622</b>	<b>44202</b>
Filtre air	<b>57463</b>	<b>75703</b>	<b>75461</b>		
Filtre direction	<b>17592</b>	<b>75642</b>	<b>75512</b>		
Filtre ad blue	<b>57929</b>	<b>75705</b>			<b>56579</b>
Filtre hydraulique ventilateur	<b>54153</b>		<b>75509</b>		

## Irisbus, Iveco

MODÈLE CROSSWAY LE MOTEUR CURSOR 9 310/360 CV - EURO 6 DEP 09/13					
DÉSIGNATION	MANN	DONALDSON	FLEETGUARD	UFI	FILTRE ORIGINE
Filtre huile				<b>94312</b>	
Filtre gasoil	<b>94307</b>				
Filtre air	<b>48125</b>	<b>75698</b>	<b>75458</b>		
Filtre hydraulique ventilateur					<b>85088</b>
Filtre ad blue			<b>94317</b>		
Filtre gasoil webasto			<b>75488</b>	<b>94311</b>	

MODÈLE ARWAY EVADYS MOTEUR CURSOR 8 352 CV - DEP 10/03 EURO 3					
DÉSIGNATION	MANN	DONALDSON	FLEETGUARD	UFI	FILTRE ORIGINE
Filtre huile	<b>42614</b>	<b>75613</b>	<b>75531</b>		<b>44854</b>
Filtre de turbo air	<b>51548</b>	<b>81381</b>	<b>75455</b>	<b>75621</b>	<b>44853</b>
Filtre reniflard 400 micron					<b>53032</b>
Joint filtre reniflard (2 par filtre)					<b>44851</b>
Filtre gasoil	<b>43941</b>	<b>75614</b>	<b>75497</b>		<b>44852</b>
Filtre air Evadys uniquement	<b>35426</b>	<b>75599</b>	<b>75453</b>		
Filtre air Arway	<b>48125</b>	<b>75698</b>	<b>75458</b>		
Filtre direction	<b>17592</b>	<b>75642</b>	<b>75512</b>		
Préfiltre gasoil	<b>57401</b>		<b>74940</b>		<b>51959</b>
Préfiltre de Webasto	<b>35087</b>	<b>81380</b>	<b>75488</b>		<b>72640</b>
Filtre hydraulique ventilateur	<b>54153</b>		<b>75509</b>		

## Kits filtration origine

RÉF ATS	CORRESPONDANCE	DÉSIGNATION
<b>81951</b>	<b>503140937</b>	kit filtre moteur Arway / Crossway moteur Cursor F2B
<b>81952</b>	<b>503140938</b>	kit filtre complet Arway / Crossway moteur Cursor F2B boîte manuelle
<b>81953</b>	<b>503140939</b>	kit filtre complet Arway moteur Cursor F2B bv voith
<b>81955</b>	<b>503140949</b>	kit filtre moteur Cursor F2B Recreo
<b>81956</b>	<b>503140950</b>	kit filtre complet moteur F2B Recreo
<b>81957</b>	<b>503140951</b>	kit filtre moteur Ares Cursor F2B
<b>81958</b>	<b>503140952</b>	kit filtre complet Ares moteur F2B
<b>84477</b>	<b>503140943</b>	Kit filtre moteur Recreo Tector F4A
<b>81954</b>	<b>503140944</b>	kit filtre complet Recreo moteur Tector
<b>84476</b>	<b>503141884</b>	Kit filtre moteur Recreo Tector Euro 5
<b>84475</b>	<b>503141885</b>	Kit filtre complet Recreo Tector Euro 5
<b>84478</b>	<b>503140961</b>	Kit filtre moteur Evadys Cursor Euro 4,5
<b>84479</b>	<b>503140962</b>	Kit filtre complet Evadys Cursor Euro 4,5

### Irisbus, Iveco

MODÈLE EVADYS MOTEUR CURSOR 10 F3AE, BE 380, 450 CV - DEP 09/06 EURO 4					
DÉSIGNATION	MANN	DONALDSON	FLEETGUARD	UFI	FILTRE ORIGINE
Filtre huile	<b>42614</b>	<b>75613</b>	<b>75531</b>		<b>44854</b>
Joint filtre reniflard (2 par filtre)					<b>44851</b>
Filtre de turbo	<b>51548</b>	<b>81381</b>	<b>75455</b>	<b>75621</b>	<b>44853</b>
Filtre reniflard jsq moteur F3AE 4415, 555 F3BE					<b>44201</b>
Joint filtre reniflard jsq moteur F3AE 4415, 555 F3BE					<b>63131</b>
Filtre reniflard dep moteur F3AE 4416, 556 F3BE					<b>53032</b>
Filtre gasoil webasto	<b>35087</b>	<b>81380</b>	<b>75488</b>	<b>94311</b>	<b>72640</b>
Filtre hydraulique ventilateur	<b>54153</b>		<b>75509</b>		
Filtre direction	<b>17592</b>	<b>75642</b>	<b>75512</b>		
Filtre ad blue	<b>57929</b>	<b>75705</b>			<b>56579</b>
Filtre air	<b>51016</b>				<b>54621</b>
Préfiltre gasoil	<b>54302</b>		<b>75507</b>	<b>75712</b>	<b>53406</b>
Cartouche combustible	<b>68305</b>				<b>56656</b>
Filtre séparateur d'eau	<b>57401</b>		<b>74940</b>		<b>51959</b>

MODÈLE FR1 MOTEUR MIDR062045 290 CV - 09/85 - 11/92					
DÉSIGNATION	MANN	DONALDSON	FLEETGUARD	UFI	FILTRE ORIGINE
Filtre huile jsq 06/88	<b>17882</b>		<b>75520</b>		
Filtre huile dep 06/88	<b>17737</b>	<b>75677</b>	<b>75521</b>		
Filtre gasoil 1 par véhicule jsq 12/88	<b>35087</b>	<b>81380</b>	<b>75488</b>	<b>94311</b>	<b>72640</b>
Filtre gasoil 2 par véhicule dep 06/88	<b>35087</b>	<b>81380</b>	<b>75488</b>		<b>72640</b>
Filtre centrifuge	<b>46520</b>		<b>75474</b>		
Filtre air	<b>36116</b>		<b>75466</b>		
Filtre boîte B9 jsq 12/88	<b>42670</b>				
Filtre boîte B9 dep 01/89					
Filtre direction	<b>17592</b>	<b>75642</b>	<b>75512</b>		
Filtre hydraulique ventilateur	<b>17681</b>				



### Irisbus, Iveco

MODÈLE FR1 MOTEUR MIDR0622045 300, 340 CV - 11/92 - 12/96					
DÉSIGNATION	MANN	DONALDSON	FLEETGUARD	UFI	FILTRE ORIGINE
Filtre huile moteur 0622045D/3	<b>17882</b>		<b>75520</b>		
Filtre huile moteur 0622045M/3	<b>17737</b>	<b>75677</b>	<b>75521</b>		
Filtre centrifuge jsq 09/95	<b>46520</b>		<b>75474</b>		
Filtre air jsq 12/93	<b>36040</b>		<b>75471</b>		
Filtre air dep 08/93	<b>35182</b>	<b>75690</b>	<b>75469</b>		
Filtre gasoil	<b>35087</b>	<b>81380</b>	<b>75488</b>	<b>94311</b>	<b>72640</b>
Filtre hydraulique ventilateur	<b>17681</b>				
Filtre direction	<b>17592</b>	<b>75642</b>	<b>75512</b>		

MODÈLE ILIADE, ARES MOTEUR MIDR0622045, MIDR0622356 300, 340, 385 CV - JSQ 09/2001 EURO 1, 2					
DÉSIGNATION	MANN	DONALDSON	FLEETGUARD	UFI	FILTRE ORIGINE
Filtre huile	<b>17737</b>	<b>75677</b>	<b>75521</b>		
Filtre centrifuge	<b>46520</b>		<b>75474</b>		
Filtre gasoil	<b>35087</b>	<b>81380</b>	<b>75488</b>	<b>94311</b>	<b>72640</b>
Filtre air	<b>70418</b>		<b>75449</b>		
Filtre hydraulique ventilateur	<b>54153</b>		<b>75509</b>		
Filtre ralentisseur hydraulique (10AS2301IT)	<b>36995</b>	<b>75684</b>	<b>75514</b>		

MODÈLE ILIADE, ARES MOTEUR DCI 11 - 310, 360, 420 CV ARES DEP 05/02 - ILIADE DEP 04/01 EURO 3					
DÉSIGNATION	MANN	DONALDSON	FLEETGUARD	UFI	FILTRE ORIGINE
Filtre huile	<b>17737</b>	<b>75677</b>	<b>75521</b>		
Filtre centrifuge	<b>46521</b>	<b>76230</b>			
Filtre gasoil avec préfiltre	<b>35087</b>	<b>81380</b>	<b>75488</b>	<b>94311</b>	<b>72640</b>
Filtre gasoil	<b>37456</b>		<b>75496</b>		
Préfiltre à gasoil	<b>51974</b>				
Filtre hydraulique ventilateur	<b>54153</b>		<b>75509</b>		
Filtre air	<b>39943</b>	<b>74728</b>	<b>75450</b>		
Filtre boîte b8l (tbv)	<b>42670</b>				
Filtre boîte automatique ZF (HP592, HP602)	<b>51467</b>	<b>75684</b>	<b>75514</b>		<b>56339</b>
Filtre direction	<b>17592</b>	<b>75642</b>	<b>75512</b>		

## Irisbus, Iveco

MODÈLE ARES MOTEUR CURSOR F2B - EURO 3					
DÉSIGNATION	MANN	DONALDSON	FLEETGUARD	UFI	FILTRE ORIGINE
Filtre huile	<b>42614</b>	<b>75613</b>	<b>75531</b>		<b>44854</b>
Filtre gasoil	<b>35087</b>	<b>81380</b>	<b>75488</b>	<b>94311</b>	<b>72640</b>
Préfiltre gasoil	<b>51974</b>				
Filtre air	<b>35426</b>	<b>75599</b>	<b>75453</b>		
Filtre de turbo	<b>51548</b>	<b>81381</b>	<b>75455</b>	<b>75621</b>	<b>44853</b>
Filtre ventilateur					<b>66722</b>
Filtre reniflard 400 microns					<b>53032</b>
Joint filtre reniflard 2 par véhicule					<b>44851</b>

MODÈLE MAGELYS HD MOTEUR CURSOR 10 450 CV - DEP 07/07 - EURO 4					
DÉSIGNATION	MANN	DONALDSON	FLEETGUARD	UFI	FILTRE ORIGINE
Filtre huile	<b>42614</b>	<b>75613</b>	<b>75531</b>		<b>44854</b>
filtre gasoil	<b>43941</b>	<b>75614</b>	<b>75497</b>	<b>75620</b>	<b>44852</b>
Préfiltre gasoil	<b>54302</b>		<b>75507</b>	<b>75712</b>	<b>53406</b>
Filtre air	<b>51016</b>				<b>54621</b>
Filtre direction	<b>17592</b>	<b>75642</b>	<b>75512</b>		
Filtre ad blue	<b>57929</b>	<b>75705</b>			<b>56579</b>
Filtre retour ventilateur	<b>54153</b>		<b>75509</b>		
Filtre huile boîte de vitesse ZF 12 AS (astronic)	<b>51467</b>	<b>75684</b>	<b>75514</b>		<b>56339</b>
Reniflard					<b>44201</b>

MODÈLE MAGELYS HD, PRO MOTEUR CURSOR 9 400 CV - EURO 6 DEP 09/13					
DÉSIGNATION	MANN	DONALDSON	FLEETGUARD	UFI	FILTRE ORIGINE
Filtre huile				<b>94312</b>	
Filtre gasoil				<b>94311</b>	<b>72640</b>
Filtre air	<b>48125</b>	<b>75698</b>			<b>69757</b>
Filtre hydraulique ventilateur					<b>85088</b>
Filtre ad blue					<b>94317</b>
Filtre gasoil séparateur d'eau					<b>94351</b>

## Isuzu

MODÈLE HARMONY MOTEUR MAN D0834LFL52 150, 180 CV				
DÉSIGNATION	MANN	DONALDSON	FLEETGUARD	FILTRE ORIGINE
Filtre huile	<b>17750</b>		<b>75523</b>	
Filtre gasoil	<b>55269</b>			
Filtre à air	<b>62818</b>			

## King Long

MODÈLE XMQ 6800 (LUDEA) MOTEUR ISBE4.5 - 207 CV				
DÉSIGNATION	MANN	DONALDSON	FLEETGUARD	FILTRE ORIGINE
Filtre huile	<b>54300</b>		<b>74945</b>	
Filtre gasoil séparateur d'eau	<b>63921</b>		<b>75805</b>	
Filtre gasoil	<b>70772</b>		<b>75804</b>	
Filtre à air	<b>51549</b>	<b>75616</b>	<b>75457</b>	

MODÈLE XMQ 6900 (FORTEM) MOTEUR ISBE6.7 - 250 CV - EURO 5				
DÉSIGNATION	MANN	DONALDSON	FLEETGUARD	FILTRE ORIGINE
Filtre huile	<b>54300</b>		<b>74945</b>	
Filtre gasoil	<b>70772</b>		<b>75804</b>	
Filtre à air	<b>51549</b>		<b>75457</b>	

MODÈLE XMQ 6120 (CITEOR) MOTEUR ISBE5 - 207 CV				
DÉSIGNATION	MANN	DONALDSON	FLEETGUARD	FILTRE ORIGINE
Filtre à gasoil	<b>53719</b>		<b>74926</b>	
Filtre à air	<b>77980</b>			
Filtre huile	<b>93540</b>		<b>81173</b>	
Filtre eau			<b>94309</b>	
Filtre ad blue	<b>57929</b>	<b>75705</b>		

MODÈLE XMQ 6127 (ALTIOR) MOTEUR ISL8.9 400 CV - EURO 5				
DÉSIGNATION	MANN	DONALDSON	FLEETGUARD	FILTRE ORIGINE
Filtre à huile	<b>93540</b>		<b>81173</b>	
Filtre à gasoil	<b>53719</b>		<b>74926</b>	
Filtre eau			<b>94309</b>	
Filtre air	<b>77980</b>			
Filtre ad blue	<b>57929</b>	<b>75705</b>		

### Man

MODÈLE MAN SU263 A72 MOTEUR D0836LOH 260 CV - DEP 09/99 EURO 2, 3				
DÉSIGNATION	MANN	DONALDSON	FLEETGUARD	FILTRE ORIGINE
Filtre huile	<b>17750</b>		<b>75523</b>	
Filtre gasoil x 2	<b>35193</b>			
Filtre air	<b>40463M</b>	<b>40463</b>		
Filtre direction	<b>17592</b>	<b>75642</b>	<b>75512</b>	

MODÈLE MAN SU313 A72 MOTEUR D2866LUH 310 CV - EURO 2, 3				
DÉSIGNATION	MANN	DONALDSON	FLEETGUARD	FILTRE ORIGINE
Filtre huile	<b>58226</b>			
Filtre gasoil x 2	<b>35193</b>			
Filtre air	<b>35076</b>			
Filtre direction	<b>17592</b>	<b>75642</b>	<b>75512</b>	

MODÈLE MAN UE/UEL (A01, A04) LION'S REGIO, LION'S REGIO L MOTEUR D2866LUH 310 CV - EURO 3				
DÉSIGNATION	MANN	DONALDSON	FLEETGUARD	FILTRE ORIGINE
Filtre huile	<b>58226</b>			
Filtre gasoil x 2	<b>35193</b>			
Filtre air	<b>35075</b>	<b>75688</b>	<b>75447</b>	
Filtre direction	<b>17592</b>	<b>75642</b>	<b>75512</b>	

MODÈLE MAN UE /UEL (R13,R14) LION'S REGIO L, C MOTEUR D2066LUH 280, 349 CV - EURO 4,5				
DÉSIGNATION	MANN	DONALDSON	FLEETGUARD	FILTRE ORIGINE
Filtre huile	<b>55271</b>		<b>75516</b>	
Filtre gasoil	<b>55269</b>		<b>75498</b>	
Préfiltre gasoil	<b>51974</b>			
Filtre hydraulique ventilateur	<b>52515</b>			
Filtre air	<b>57463</b>	<b>75703</b>	<b>75461</b>	
Filtre direction	<b>17592</b>	<b>75642</b>	<b>75512</b>	
Filtre de boîte de vitesse 12AS (astronic)	<b>36995</b>	<b>75684</b>	<b>75514</b>	



### Man

MODÈLE INTERCITY R60, R61 MOTEUR D0836LOH 290 CV - EURO 6 DEP 03/15				
DÉSIGNATION	MANN	DONALDSON	FLEETGUARD	FILTRE ORIGINE
Filtre huile	<b>17750</b>			
Filtre gasoil	<b>55269</b>		<b>75498</b>	
Préfiltre primaire	<b>51974</b>			
Filtre séparateur d'eau avec rechauffeur	<b>91325</b>			
Filtre séparateur sans chauffage intègre	<b>94346</b>			
Filtre air	<b>94347</b>			
Filtre boîte de vitesse 6F1901 Intarder	<b>36995</b>	<b>75684</b>	<b>77514</b>	
Filtre ad blue	<b>84960</b>			
Filtre primaire ad blue (vendu par 10)	<b>94348</b>			
Filtre de direction	<b>17592</b>	<b>75642</b>	<b>75512</b>	

MODÈLE MAN LION'S COACH R07, R08 MOTEUR D2866LOH034 410 CV - DEP 09/02 EURO 3				
DÉSIGNATION	MANN	DONALDSON	FLEETGUARD	FILTRE ORIGINE
Filtre huile (sur échangeur de température)	<b>38386</b>			
Filtre gasoil	<b>45531</b>			
Filtre air H 480 mm - Ø 251 mm	<b>51647</b>			
Filtre direction	<b>17592</b>	<b>75642</b>	<b>75512</b>	
Filtre hydraulique ventilateur	<b>64079</b>			

MODÈLE MAN LION'S COACH R07, R08 MOTEUR D2066LOH 440 CV - DEP 07/06 EURO 4				
DÉSIGNATION	MANN	DONALDSON	FLEETGUARD	FILTRE ORIGINE
Filtre huile	<b>55271</b>		<b>75516</b>	
Filtre gasoil	<b>55269</b>		<b>75498</b>	
Préfiltre gasoil	<b>51974</b>			
Filtre air	<b>53936</b>			
Filtre de boîte as tronic ZF	<b>36995</b>	<b>75684</b>	<b>75514</b>	
Filtre hydraulique ventilateur	<b>52515</b>			
Filtre direction	<b>17592</b>	<b>75642</b>	<b>75512</b>	
Préfiltre de webasto, eberspacher	<b>62118</b>		<b>77088</b>	

## Man

MODÈLE MAN CHÂSSIS 469 MARCO POLO, TROUILLET MOTEUR D0826LOH 221 CV - DEP 10/95				
DÉSIGNATION	MANN	DONALDSON	FLEETGUARD	FILTRE ORIGINE
Filtre huile	<b>17750</b>		<b>75523</b>	
Filtre gasoil sans purge d'eau	<b>35193</b>			

## Neoplan

MODÈLE NEOPLAN N312 U, N316 U MOTEUR OM441LA EURO 1, 2				
DÉSIGNATION	MANN	DONALDSON	FLEETGUARD	FILTRE ORIGINE
Filtre à huile	<b>35083</b>		<b>75564</b>	
Filtre à gasoil	<b>13121</b>		<b>75485</b>	
Filtre à air	<b>35075</b>	<b>75688</b>	<b>75447</b>	
Filtre direction	<b>17592</b>	<b>75642</b>	<b>75512</b>	

MODÈLE N33 12, N33 16 EUROLINER MOTEUR OM501LA MERCEDES EURO 3 DEP 2002				
DÉSIGNATION	MANN	DONALDSON	FLEETGUARD	FILTRE ORIGINE
Filtre huile	<b>45273</b>			
Filtre gasoil	<b>38058</b>		<b>75493</b>	
Filtre séparateur support parker	<b>54292</b>		<b>75508</b>	
Filtre air	<b>35076</b>			

MODÈLE N33 12, N33 16 EUROLINER MOTEUR MAN D2866LUH25, D2866LUH30				
DÉSIGNATION	MANN	DONALDSON	FLEETGUARD	FILTRE ORIGINE
Filtre huile	<b>58226</b>			
Filtre gasoil	<b>35193</b>			
Filtre air	<b>35076</b>			
Filtre direction	<b>17592</b>	<b>75642</b>	<b>75512</b>	



## Neoplan

MODÈLE NEOPLAN TRENDLINER MAN N3516UE MOTEUR D2866LUH 310, 360, 409 CV - DEP 09/04 JSQ 07/06 EURO 3				
DÉSIGNATION	MANN	DONALDSON	FLEETGUARD	FILTRE ORIGINE
Filtre huile	<b>58226</b>			
Filtre gasoil	<b>51280</b>			
Filtre air	<b>51647</b>			
Filtre webasto	<b>62118</b>		<b>77088</b>	
Filtre hydraulique ventilateur	<b>64079</b>	<b>75627</b>		
Filtre direction	<b>17592</b>	<b>75642</b>	<b>75512</b>	
Préfiltre gasoil	<b>64085</b>			

MODÈLE NEOPLAN TRENDLINER MAN MOTEUR D2066LUH 390 CV - DEP 07/06 EURO 4				
DÉSIGNATION	MANN	DONALDSON	FLEETGUARD	FILTRE ORIGINE
Filtre huile	<b>55271</b>		<b>75516</b>	
Filtre gasoil	<b>55269</b>		<b>75498</b>	
Filtre air	<b>57463</b>	<b>75703</b>	<b>75461</b>	
Filtre webasto	<b>62118</b>		<b>77088</b>	
Filtre hydraulique ventilateur	<b>64079</b>	<b>75627</b>		
Filtre direction	<b>17592</b>	<b>75642</b>	<b>75512</b>	

MODÈLE NEOPLAN TOURLINER P21 N2216 MAN MOTEUR D2866LOH34 410 CV - DEP 09/03 EURO 3				
DÉSIGNATION	MANN	DONALDSON	FLEETGUARD	FILTRE ORIGINE
Filtre huile	<b>38386</b>			
Filtre gasoil x 2	<b>35193</b>			
Filtre gasoil	<b>45531</b>			
Filtre air	<b>35076</b>			
Filtre direction	<b>17592</b>	<b>75642</b>	<b>75512</b>	

MODÈLE NEOPLAN TOURLINER N2216 (CREEV) - MOTEUR D2066LOH04 441 CV - DEP 06/06 EURO 4, 5				
DÉSIGNATION	MANN	DONALDSON	FLEETGUARD	FILTRE ORIGINE
Filtre huile	<b>55271</b>		<b>75516</b>	
Filtre gasoil	<b>55269</b>		<b>75498</b>	
Préfiltre gasoil	<b>51974</b>			
Filtre air	<b>53936</b>			
Filtre direction	<b>17592</b>	<b>75642</b>	<b>75512</b>	

### Otokar

MODÈLE OTOKAR NAVIGO 145S, 165S MOTEUR DEUTZ BF4M1013FC				
DÉSIGNATION	MANN	DONALDSON	FLEETGUARD	FILTRE ORIGINE
Filtre huile	<b>17883</b>			
Filtre gasoil	<b>35086</b>			
Filtre direction	<b>17592</b>	<b>75642</b>	<b>75512</b>	

MODÈLE OTOKAR NAVIGO MOTEUR CUMMINS ISBE4-160B 167 CV - EURO 4				
DÉSIGNATION	MANN	DONALDSON	FLEETGUARD	FILTRE ORIGINE
Filtre huile	<b>54300</b>		<b>74945</b>	<b>44858</b>
Filtre gasoil	<b>53719</b>		<b>74926</b>	<b>44859</b>
Filtre air primaire			<b>74942</b>	
Filtre air secondaire			<b>74943</b>	
Filtre séparateur d'eau			<b>74944</b>	
Filtre direction	<b>17592</b>	<b>75642</b>	<b>75512</b>	

MODÈLE OTOKAR VECTIO MOTEUR MAN D0836LOH56 DEP 2008 - EURO 4				
DÉSIGNATION	MANN	DONALDSON	FLEETGUARD	FILTRE ORIGINE
Filtre huile	<b>17750</b>		<b>75523</b>	
Filtre gasoil	<b>55269</b>			
Filtre air	<b>65063</b>			
Préfiltre gasoil	<b>51974</b>			

### Renault

MODÈLE TRAFIC 90 DCI, 125 DCI MOTEUR 2L DCI M9R-630, M9R-682, M9R-780 DEP 09/06 - EURO 4				
DÉSIGNATION	MANN	DONALDSON	FLEETGUARD	FILTRE ORIGINE
Filtre huile	<b>70377</b>			
Filtre gasoil (support purflux) FC579 + FC581	<b>62754</b>			
Filtre gasoil (support purflux) FC580	<b>53517</b>			
Filtre air	<b>52041</b>			
Filtre climatisation	<b>73078</b>			



### Renault

MODÈLE MASTER 3, 100 DCI, 120 DCI MOTEUR G9U 750 / 754 MOTEUR 2,5 DCI 100, 120 CV - DEP 10/03 JSQ 07/06				
DÉSIGNATION	MANN	DONALDSON	FLEETGUARD	FILTRE ORIGINE
Filtre huile	<b>52129</b>	<b>MANN</b>		
Filtre gasoil (support Delphi)	<b>70083</b>	<b>MANN</b>		
Filtre à gasoil (support Purflux)	<b>53517</b>	<b>MANN</b>		
Filtre air	<b>56469</b>	<b>MANN</b>		

MODÈLE MASTER 3, 100 DCI, 120 DCI, 150 DCI MOTEUR G9U 650, G9U 632, MOTEUR 2,5 DCI 100, 120, 148 CV - DEP 07/06 JSQ 06/10				
DÉSIGNATION	MANN	DONALDSON	FLEETGUARD	FILTRE ORIGINE
Filtre huile	<b>70377</b>			
Filtre gasoil (support Delphi)	<b>70083</b>			
Filtre à gasoil (support Purflux)	<b>53517</b>			
Filtre air	<b>56469</b>			

MODÈLE MASTER 3, 140 DCI, 160 DCI MOTEUR ZD3 200/202/203, MOTEUR 3L DCI 136, 156 CV - DEP 01/04 JSQ 06/10				
DÉSIGNATION	MANN	DONALDSON	FLEETGUARD	FILTRE ORIGINE
Filtre huile	<b>73076</b>			
Filtre gasoil (support delphi)	<b>70083</b>			
Filtre à gasoil (support purflux)	<b>53517</b>			
Filtre air	<b>73077</b>			

MODÈLE MASCOTT MOTEUR 8140 43K, DCI, 2,8 LITRES DEP 02/00 JSQ 07/04				
DÉSIGNATION	MANN	DONALDSON	FLEETGUARD	FILTRE ORIGINE
Filtre huile	<b>35474</b>		<b>75522</b>	
Filtre gasoil	<b>35090</b>		<b>75487</b>	
Filtre séparateur d'eau	<b>71693</b>			
Filtre air	<b>52522</b>			



## Scania

MODÈLE SCANIA IRIZAR CENTURY 12-35, 37, 85 MOTEUR DSC1205 - 382 CV DEP 05/96 JSQ 05/05 MOTEUR DC11-04 - 420 CV EURO 2,3 • DC12				
DÉSIGNATION	MANN	DONALDSON	FLEETGUARD	FILTRE ORIGINE
Filtre huile	<b>17738M</b>		<b>17738</b>	
Filtre gasoil euro 2	<b>17724</b>		<b>75490</b>	
Filtre gasoil euro 3	<b>42986</b>			
Filtre air	<b>35075</b>	<b>75688</b>	<b>75447</b>	
Filtre voith	<b>63580</b>			
Filtre direction	<b>17592</b>	<b>75642</b>	<b>75512</b>	

MODÈLE SCANIA K114 - 360 CV DEP 11/05 • SCANIA K124 - MOTEUR DC 12 - CV 421 - EURO 4 • IRIZAR PB - MOTEUR DC11 - EURO 4				
DÉSIGNATION	MANN	DONALDSON	FLEETGUARD	FILTRE ORIGINE
Filtre huile	<b>17738M</b>		<b>17738</b>	
Filtre gasoil	<b>57703</b>			
Filtre air	<b>57463</b>	<b>75703</b>	<b>75461</b>	
Filtre voith	<b>63580</b>			
Filtre hydraulique ventilateur	<b>64079</b>	<b>75627</b>		
Filtre direction	<b>17592</b>	<b>75642</b>	<b>75512</b>	
Filtre webasto	<b>62118</b>		<b>77088</b>	

MODÈLE SCANIA PB IRIZAR 12.3/12.9/13.8/12.3 - MOTEUR DC13 - ANNÉE DEP 09/08				
DÉSIGNATION	MANN	DONALDSON	FLEETGUARD	FILTRE ORIGINE
Filtre à huile	<b>74619</b>			<b>75561</b>
Filtre gasoil	<b>82122</b>			
Filtre air	<b>57463</b>	<b>75703</b>		<b>75461</b>
Filtre boîte de vitesse	<b>17849</b>			
Filtre retarder	<b>63580</b>			
Filtre direction	<b>17592</b>	<b>75642</b>		<b>75512</b>

## Scania

MODÈLE SCANIA I4 MOTEUR DC9-22/32 - 320 CV DEP 09/08 MOTEUR DC9 -29/36 - 280 CV				
DÉSIGNATION	MANN	DONALDSON	FLEETGUARD	FILTRE ORIGINE
Filtre huile	<b>64080</b>			
Filtre gasoil	<b>74619</b>		<b>75561</b>	
Filtre air	<b>57463</b>	<b>75703</b>	<b>75461</b>	
Filtre boîte automatique 6H9592/602	<b>51467</b>	<b>75684</b>	<b>75514</b>	<b>56339</b>
Filtre direction	<b>17592</b>	<b>75642</b>	<b>75512</b>	
Filtre hydraulique ventilateur	<b>64081</b>			

MODÈLE SCANIA TOURING HIGER HD12 - MOTEUR DC/DT1310440 440 CV - ANNÉE DEP 02/10 EURO 5				
DÉSIGNATION	MANN	DONALDSON	FLEETGUARD	FILTRE ORIGINE
Filtre huile	<b>74619</b>		<b>75561</b>	
Filtre gasoil	<b>82122</b>			
Filtre à air	<b>57463</b>	<b>75703</b>	<b>75461</b>	
Filtre retarder	<b>63580</b>			
Filtre ventilateur hydraulique	<b>64081</b>			
Filtre direction	<b>17592</b>	<b>75642</b>	<b>75512</b>	

MODÈLE SCANIA TOURING HD12-360, MOTEUR DC09112E6 HD12-410, MOTEUR DC13125E6, HD12-450, HD12-490, MOTEUR DC1314E6 - EURO 6 DEP 01/14				
DÉSIGNATION	MANN	DONALDSON	FLEETGUARD	FILTRE ORIGINE
Filtre huile	<b>74619</b>			
Filtre gasoil	<b>82122</b>			
Filtre air	<b>57463</b>	<b>75703</b>	<b>75461</b>	
Filtre ventilateur hydraulique	<b>64081</b>			
Filtre direction	<b>17592</b>	<b>75642</b>	<b>75512</b>	
Filtre boîte de vitesse manuel	<b>17849</b>			
Filtre retarder	<b>63580</b>			

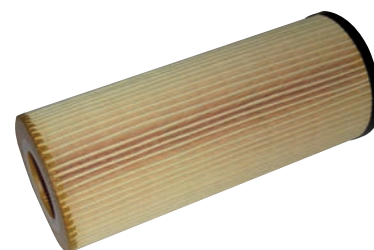

### Scania

MODÈLE OMNICITY 11/12/18 MOTEUR DC917270 - 270 CV, DC918310 - 310 CV, DC916230 - 230 CV, DC9E02270 - 270 CV - DEP 09/06				
DÉSIGNATION	MANN	DONALDSON	FLEETGUARD	FILTRE ORIGINE
Filtre huile	<b>17738M</b>		<b>17738</b>	
Filtre gasoil	<b>57703</b>			
Filtre air	<b>57463</b>	<b>75703</b>	<b>75461</b>	
Filtre direction	<b>17592</b>	<b>75642</b>	<b>75512</b>	
Filtre hydraulique ventilateur	<b>64081</b>			
Filtre boîte de vitesse ZF 4/5/6 HP 502/592/602	<b>51467</b>	<b>75684</b>	<b>75514</b>	<b>56339</b>

MODÈLE OMNICITY MOTEUR DC930/35-230 - 230 CV, DC9 29/36-280 - 280 CV - DEP 09/2008				
DÉSIGNATION	MANN	DONALDSON	FLEETGUARD	FILTRE ORIGINE
Filtre huile	<b>64080</b>			
Filtre air	<b>57463</b>	<b>75703</b>	<b>75461</b>	
Filtre ventilateur	<b>64081</b>			
Filtre boîte de vitesse ZF 4/5/6 HP 502/592/602	<b>51467</b>	<b>75684</b>	<b>75514</b>	<b>56339</b>
Filtre direction	<b>17592</b>	<b>75642</b>	<b>75512</b>	

### Solaris

MODÈLE SOLARIS URBINO MOTEUR MAN - MOTEUR D0824, D0826				
DÉSIGNATION	MANN	DONALDSON	FLEETGUARD	FILTRE ORIGINE
Filtre huile	<b>17750</b>		<b>75523</b>	
Filtre air	<b>55187</b>	<b>74727</b>	<b>75454</b>	
Préfiltre gasoil	<b>56486</b>	<b>75675</b>	<b>75504</b>	
Filtre gasoil	<b>35193</b>			

MODÈLE SOLARIS URBINO MOTEUR DAF MOTEUR DAF PE183C, DAF PF235M EURO 3				
DÉSIGNATION	MANN	DONALDSON	FLEETGUARD	FILTRE ORIGINE
Filtre huile	<b>55221</b>			
Filtre air	<b>55187</b>	<b>74727</b>	<b>75454</b>	
Filtre gasoil	<b>45156</b>			
Filtre huile centrifuge	<b>53002</b>		<b>75475</b>	

### Solaris

MODÈLE SOLARIS URBINO MOTEUR DAF MOTEUR DAF PR228 S, MOTEUR DAF PR265 S - EURO 4				
DÉSIGNATION	MANN	DONALDSON	FLEETGUARD	FILTRE ORIGINE
Filtre huile	<b>55221</b>			
Filtre air	<b>57264</b>			
Filtre huile centrifuge	<b>53002</b>		<b>75475</b>	
Filtre gasoil	<b>54563</b>			
Préfiltre gasoil	<b>52614</b>			
Filtre ad blue	<b>57929</b>	<b>75705</b>		<b>56579</b>
Filtre additionnel SCR	<b>63522</b>		<b>74928</b>	<b>72641</b>

MODÈLE SOLARIS URBINO U18 HYBRID MOTEUR ISBE5 250 CV - DEP 10/06				
DÉSIGNATION	MANN	DONALDSON	FLEETGUARD	FILTRE ORIGINE
Filtre à huile	<b>70778</b>			
Filtre à gasoil	<b>53719</b>		<b>74926</b>	
Filtre à air	<b>57264</b>	<b>75079</b>		
Filtre direction	<b>17592</b>	<b>75642</b>	<b>75512</b>	
Filtre boîte Voith Di WA854-5, 864-5	<b>77152</b>			

### Temsa

MODÈLE TEMSA SAMBA MAN MOTEUR D0834LFLO3 180 CV - DEP 01/01				
DÉSIGNATION	MANN	DONALDSON	FLEETGUARD	FILTRE ORIGINE
Filtre huile	<b>17750</b>		<b>75523</b>	
Filtre gasoil	<b>35193</b>			
Filtre air	<b>13226</b>	<b>75686</b>	<b>75446</b>	
Filtre direction	<b>17592</b>	<b>75642</b>	<b>75512</b>	

MODÈLE TEMSA OPALIN MAN MOTEUR D0834LOH51, D0836LOH52 206, 240 CV - DEP 09/05 - EURO 3				
DÉSIGNATION	MANN	DONALDSON	FLEETGUARD	FILTRE ORIGINE
Filtre huile	<b>17750</b>		<b>75523</b>	
Filtre gasoil	<b>55269</b>			
Préfiltre gasoil	<b>51974</b>			
Filtre air (bg124)	<b>53255</b>			
Filtre air (bg136)	<b>13226</b>	<b>75686</b>	<b>75446</b>	
Filtre direction	<b>17592</b>	<b>75642</b>	<b>75512</b>	

## Temsa

MODÈLE TEMSA OPALIN MAN - EURO 4				
DÉSIGNATION	MANN	DONALDSON	FLEETGUARD	FILTRE ORIGINE
Filtre huile	<b>17627</b>			
Filtre gasoil	<b>55269</b>			
Filtre air	<b>57264</b> <b>75079</b>			

MODÈLE TEMSA MD9C MOTEUR D0836LOH65 250 CV - DEP 10/2010				
DÉSIGNATION	MANN	DONALDSON	FLEETGUARD	FILTRE ORIGINE
Filtre huile	<b>17750</b>		<b>75523</b>	
Filtre gasoil	<b>55269</b>			
Préfiltre gasoil	<b>51974</b>			
Filtre air	<b>13226</b>	<b>75686</b>	<b>75446</b>	
Filtre direction	<b>17592</b>	<b>75642</b>	<b>75512</b>	
Filtre climatisation (Webasto)	<b>53318</b>			

MODÈLE TEMSA METROPOL MAN MOTEUR D0834LOH51 - 206 CV, D0836LOH52 - 240 CV - DEP 10/06				
DÉSIGNATION	MANN	DONALDSON	FLEETGUARD	FILTRE ORIGINE
Filtre huile	<b>17750</b>		<b>75523</b>	
Filtre gasoil	<b>55269</b>			
Préfiltre gasoil	<b>51974</b>			
Filtre air	<b>13226</b>	<b>75686</b>	<b>75446</b>	
Filtre direction	<b>17592</b>	<b>75642</b>	<b>75512</b>	

MODÈLE TEMSA TOURMALIN DAF BOX MOTEUR PR228S2 310 CV - DEP 10/06 - EURO 4, 5				
DÉSIGNATION	MANN	DONALDSON	FLEETGUARD	FILTRE ORIGINE
Filtre huile	<b>48001</b>		<b>75515</b>	
Filtre gasoil	<b>54563</b>			
Filtre additional SCR-system	<b>63522</b>		<b>74928</b>	<b>72641</b>
Filtre air	<b>48991</b>	<b>74725</b>		
Filtre ad blue	<b>57929</b>	<b>75705</b>		<b>56579</b>
Filtre direction	<b>17592</b>	<b>75642</b>	<b>75512</b>	
Filtre liquide refroidissement	<b>52517</b>			



## Temsa

MODÈLE TEMSA BOX MAN MOTEUR D2866LUH24 - 310 CV - EURO 3				
DÉSIGNATION	MANN	DONALDSON	FLEETGUARD	FILTRE ORIGINE
Filtre huile	<b>58226</b>			
Filtre gasoil	<b>35193</b>			
Filtre direction	<b>17592</b>	<b>75642</b>	<b>75512</b>	
Filtre air	<b>35076</b>			

MODÈLE TEMSA BOX LIGHT 12, TEMSA BOX LIGHT 13 MOTEUR CUMMINS ISBE4 300 CV - EURO 4				
DÉSIGNATION	MANN	DONALDSON	FLEETGUARD	FILTRE ORIGINE
Filtre huile	<b>54300</b>		<b>74945</b>	<b>44858</b>
Filtre gasoil	<b>53719</b>		<b>74926</b>	<b>44859</b>
Filtre air			<b>74937</b>	
Filtre séparateur d'eau			<b>74944</b>	

MODÈLE TEMSA BOX 12, 13 MOTEUR ISBE 6.7 - 300 CV - EURO 5				
DÉSIGNATION	MANN	DONALDSON	FLEETGUARD	FILTRE ORIGINE
Filtre huile	<b>54300</b>		<b>74945</b>	
Filtre gasoil	<b>70772</b>		<b>75804</b>	
Filtre séparateur d'eau			<b>74939</b>	
Filtre à air			<b>74398</b>	
Filtre à air sécurité			<b>74397</b>	

MODÈLE TEMSA SAFARI MAN MOTEUR D2866LOH28 360 CV - DEP 01/01				
DÉSIGNATION	MANN	DONALDSON	FLEETGUARD	FILTRE ORIGINE
Filtre huile	<b>58226</b>			
Filtre gasoil	<b>35193</b>			
Filtre air	<b>35076</b>			
Filtre direction	<b>17592</b>	<b>75642</b>	<b>75512</b>	

MODÈLE TEMSA SAFARI HD12,13 DAF MOTEUR MX300 - 410 CV - DEP 10/06				
DÉSIGNATION	MANN	DONALDSON	FLEETGUARD	FILTRE ORIGINE
Filtre huile	<b>57705</b>			
Filtre gasoil	<b>54563</b>			
Filtre centrifuge	<b>54155</b>			
Filtre air	<b>48991</b>	<b>74725</b>		
Filtre direction	<b>17592</b>	<b>75642</b>	<b>75512</b>	
Filtre ad blue	<b>57929</b>	<b>75705</b>		<b>56579</b>
Filtre liquide de refroidissement	<b>52517</b>			

### Temsa

MODÈLE TEMSA SAFARI RD12,13 DAF MOTEUR PR265 - 360 CV - DEP 10/06				
DÉSIGNATION	MANN	DONALDSON	FLEETGUARD	FILTRE ORIGINE
Filtre huile	<b>48001</b>			
Filtre gasoil	<b>54563</b>			
Filtre air	<b>48991</b>	<b>74725</b>		
Filtre ad blue	<b>57929</b>	<b>75705</b>		<b>56579</b>
Filtre direction	<b>17592</b>	<b>75642</b>	<b>75512</b>	
Filtre liquide de refroidissement	<b>52517</b>			

MODÈLE TEMSA DIAMOND MOTEUR MAN D2876LOH, MAN D2676LOH 460, 480 CV - DEP 09/04 - EURO 3				
DÉSIGNATION	MANN	DONALDSON	FLEETGUARD	FILTRE ORIGINE
Filtre huile	<b>38386</b>			
Filtre gasoil	<b>45531</b>			
Filtre air	<b>53936</b>			
Préfiltre gasoil	<b>64085</b>			
Filtre direction	<b>17592</b>	<b>75642</b>	<b>75512</b>	
Filtre hydraulique ventilateur	<b>64079</b>	<b>75627</b>		

### Vanhool

MODÈLE A308 - MOTEUR MAN 0836LOH03 - 220 CV - EURO 3				
DÉSIGNATION	MANN	DONALDSON	FLEETGUARD	FILTRE ORIGINE
Filtre huile	<b>17627</b>			
Filtre gasoil x 2	<b>35084</b>	<b>75633</b>		
Filtre air	<b>42592</b>		<b>75464</b>	
Filtre direction	<b>17592</b>	<b>75642</b>	<b>75512</b>	

MODÈLE AG300 MOTEUR MAN D2865LOH 320 CV - DEP 07/92				
DÉSIGNATION	MANN	DONALDSON	FLEETGUARD	FILTRE ORIGINE
Filtre huile	<b>58226</b>			
Filtre gasoil	<b>35193</b>			

MODÈLE AG300 MOTEUR MAN D2866LOH27 310 CV - DEP 09/03				
DÉSIGNATION	MANN	DONALDSON	FLEETGUARD	FILTRE ORIGINE
Filtre huile	<b>38386</b>			
Filtre gasoil	<b>35193</b>			
Filtre air	<b>55254</b>	<b>74724</b>		

### Vanhool

MODÈLE AG300, AGG300 MOTEUR DAF PE265C 360 CV - DEP 10/02 EURO 3				
DÉSIGNATION	MANN	DONALDSON	FLEETGUARD	FILTRE ORIGINE
Filtre huile hauteur 150 mm	<b>48001</b>			
Filtre huile hauteur 220 mm	<b>55221</b>			
Filtre huile centrifuge	<b>53002</b>		<b>75475</b>	
Filtre gasoil hauteur 205 mm	<b>45156</b>			
Filtre gasoil hauteur 250 mm	<b>73056</b>			
Filtre air	<b>55254</b>	<b>74724</b>		

MODÈLE A500/3 MOTEUR 5 CYLINDRES MOTEUR MAN D2865				
DÉSIGNATION	MANN	DONALDSON	FLEETGUARD	FILTRE ORIGINE
Filtre huile	<b>35080</b>		<b>75519</b>	
Filtre air	<b>51476</b>			
Filtre gasoil	<b>35086</b>			
Filtre voith				<b>38111</b>

MODÈLE A300 GPL MOTEUR DAF				
DÉSIGNATION	MANN	DONALDSON	FLEETGUARD	FILTRE ORIGINE
Filtre huile hydraulique	<b>17879</b>			
Filtre air	<b>35072</b>	<b>75628</b>	<b>75464</b>	
Filtre voith				<b>38111</b>

MODÈLE T815, ACRON, ALICRON, T815 CL, T816 ALTANO MOTEUR MAN D2866LUH, D2866LOH 313, 360 CV - EURO 0, 1				
DÉSIGNATION	MANN	DONALDSON	FLEETGUARD	FILTRE ORIGINE
Filtre huile	<b>35080</b>		<b>75519</b>	
Filtre séparateur d'eau	<b>40146</b>			
Filtre gasoil primaire	<b>35085</b>	<b>75670</b>	<b>75477</b>	
Filtre gasoil secondaire	<b>13120</b>	<b>75634</b>	<b>75478</b>	
Filtre air	<b>35072</b>	<b>75628</b>	<b>75464</b>	
Filtre direction	<b>17592</b>	<b>75642</b>	<b>75512</b>	
Filtre liquide de refroidissement	<b>51305</b>			

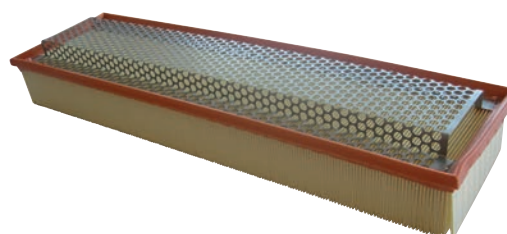

## Vanhool

MODÈLE T9 CL MOTEUR D2866LUH20 - 310 CV - EURO 2				
DÉSIGNATION	MANN	DONALDSON	FLEETGUARD	FILTRE ORIGINE
Filtre huile	<b>35080</b>		<b>75519</b>	
Filtre séparateur d'eau	<b>40146</b>			
Filtre gasoil	<b>35193</b>			
Filtre air	<b>56872</b>	<b>74730</b>		
Filtre direction	<b>17592</b>	<b>75642</b>	<b>75512</b>	
Filtre liquide de refroidissement	<b>73921</b>			

MODÈLE T915 ACRON, T916 ALICRON, T917 ALTANO, TD924 ASTROMEGA MOTEUR MAN D2866LOH29, MAN D2876LOH02 410, 460 CV - DEP 09/04 - EURO 3				
DÉSIGNATION	MANN	DONALDSON	FLEETGUARD	FILTRE ORIGINE
Filtre huile	<b>38386</b>			
Filtre séparateur d'eau	<b>40146</b>			
Filtre gasoil	<b>55269</b>			
Filtre air	<b>56872</b>	<b>74730</b>		
Filtre direction	<b>17592</b>	<b>75642</b>	<b>75512</b>	
Filtre webasto	<b>17698</b>			

MODÈLE T916 ALICRON, T915 ACRON MOTEUR MAN D2066LOH06, D2066LOH07 400 CV - DEP 09/08 - EURO 4, 5				
DÉSIGNATION	MANN	DONALDSON	FLEETGUARD	FILTRE ORIGINE
Filtre huile	<b>55271</b>		<b>75516</b>	
Filtre gasoil	<b>55269</b>			
Filtre air		<b>74732</b>		<b>63132</b>
Filtre direction	<b>17592</b>	<b>75642</b>	<b>75512</b>	
Filtre webasto	<b>17698</b>		<b>75482</b>	

MODÈLE T915 ACRON, T916 ACRON, T916 ALICRON, T917 ASTRON, T927 ASTROMEGA MOTEUR DAF XE315C - 430 CV, MOTEUR DAF XE355C - 483 CV - DEP 09/04 - EURO 3				
DÉSIGNATION	MANN	DONALDSON	FLEETGUARD	FILTRE ORIGINE
Filtre huile	<b>55221</b>			
Filtre gasoil	<b>62820</b>			
Filtre air	<b>55254</b>	<b>74724</b>		
Filtre huile centrifuge	<b>53002</b>		<b>75475</b>	
Filtre direction	<b>17592</b>	<b>75642</b>	<b>75512</b>	
Filtre webasto	<b>17698</b>		<b>75482</b>	

## Vanhool

MODÈLE T911, T916 ACRON, T916 ALICRON, T917 ASTRON, TD925 ASTROMEGA, T918 MOTEUR DAF MX300S - 510 CV, MOTEUR DAF MX375S - 410 CV DEP 09/08 EURO 4, 5				
DÉSIGNATION	MANN	DONALDSON	FLEETGUARD	FILTRE ORIGINE
Filtre huile	<b>57705</b>			
Filtre gasoil	<b>54563</b>			
Filtre air		<b>74732</b>		<b>63132</b>
Filtre séparateur d'eau	<b>52614</b>			
Filtre additionnel	<b>63522</b>		<b>74928</b>	<b>72641</b>
Filtre direction	<b>17592</b>	<b>75642</b>	<b>75512</b>	
Filtre ad blue	<b>57929</b>	<b>75705</b>		<b>56579</b>
Filtre webasto	<b>17698</b>		<b>75482</b>	

MODÈLE TX 11 DAF ALICRON MOTEUR PR265 360 CV - DEP 10/11 - EURO 5				
DÉSIGNATION	MANN	DONALDSON	FLEETGUARD	FILTRE ORIGINE
Filtre huile	<b>55221</b>			
Filtre gasoil	<b>73056</b>			
Filtre huile centrifuge	<b>53002</b>			
Filtre séparateur d'eau	<b>52614</b>			
Filtre AD Blue	<b>57929</b>			
Filtre dessiccateur	<b>65647</b>			
Filtre direction	<b>17592</b>	<b>75642</b>	<b>75512</b>	
Filtre air primaire			<b>74732</b>	

MODÈLE TX 15, 16, 17, 18, 19, 20, 21, 25, 27 DAF ASTRONEF, ACRON, ALICRON, ALTANO, ASTROMEGA MOTEUR MX300 - 408 CV, MOTEUR MX340 - 462 CV, MOTEUR MX375 - 510 CV DEP 10/11 - EURO 5				
DÉSIGNATION	MANN	DONALDSON	FLEETGUARD	FILTRE ORIGINE
Filtre huile	<b>57705</b>			
Filtre gasoil	<b>54563</b>			
Filtre séparateur d'eau	<b>52614</b>			
Filtre huile centrifuge	<b>54155</b>			
Filtre AD Blue	<b>57929</b>	<b>75705</b>		
Filtre dessiccateur	<b>65647</b>			
Filtre air primaire			<b>74732</b>	
Filtre boîte as tronic	<b>72724</b>			

## Vanhool

### MODÈLE TX 11, 15, 16, ACRON, ALICRON MOTEUR MX 11 - DEP 2015 - EURO 6

DÉSIGNATION	MANN	DONALDSON	FLEETGUARD	FILTRE ORIGINE
filtre huile	<b>94296</b>			<b>93574</b>
filtre huile centrifuge				<b>94298</b>
filtre séparateur d'eau				<b>91469</b>
filtre gasoil				<b>91468</b>
filtre air (grand)		<b>74732</b>		<b>63132</b>
filtre direction	<b>17592</b>	<b>75642</b>	<b>75512</b>	
filtre dessicateur	<b>65647</b>			

### MODÈLE TX 15, 16, 17, ACRON, ASTRONEF, ALTANO, ASTRON, ASTRONMEGA MOTEUR MX 13 - DEP 2015 - EURO 6

DÉSIGNATION	MANN	DONALDSON	FLEETGUARD	FILTRE ORIGINE
Filtre huile	<b>57505</b>		<b>94297</b>	<b>72472</b>
filtre huile centrifuge	<b>54155</b>			
filtre séparateur d'eau				<b>91469</b>
filtre gasoil				<b>91468</b>
filtre air		<b>74732</b>		<b>63132</b>

## VDL

### MODÈLE CITEA MOTEUR DAF PR228S - DEP 05/2007

DÉSIGNATION	MANN	DONALDSON	FLEETGUARD	FILTRE ORIGINE
Filtre huile	<b>55221</b>			
Filtre gasoil	<b>73056</b>			
Filtre air	<b>67031</b>	<b>74729</b>		
Filtre centrifuge	<b>53002</b>		<b>75475</b>	
Filtre direction	<b>17592</b>	<b>75642</b>	<b>75512</b>	
Filtre dessicateur	<b>65647</b>			
Filtre ad blue	<b>57929</b>	<b>75705</b>		<b>56579</b>
Filtre boîte ZF HP 500	<b>51467</b>	<b>75684</b>	<b>75514</b>	<b>56339</b>

## Volvo

### MODÈLE VOLVO 7450 - MOTEUR D12/A/420 - 421 CV - DEP 04/99

DÉSIGNATION	MANN	DONALDSON	FLEETGUARD	FILTRE ORIGINE
Filtre huile x 2	<b>17739</b>	<b>75679</b>	<b>75518</b>	
Filtre huile secondaire	<b>35095</b>			
Filtre gasoil	<b>35092</b>			
Filtre air	<b>35974</b>	<b>74731</b>		
Filtre eau de refroidissement	<b>60253</b>			

## Volvo

### MODÈLE VOLVO 7700 MOTEUR D9B260 - 260 CV, MOTEUR D9B310 - 310 CV, MOTEUR D9B360 - 360 CV DEP 09/06 - EURO 4, 5

DÉSIGNATION	MANN	DONALDSON	FLEETGUARD	FILTRE ORIGINE
Filtre huile longue durée x 2	<b>42229</b>			
Filtre huile secondaire	<b>35095</b>			
Filtre gasoil	<b>60159</b>			
Filtre air		<b>73841</b>		<b>57214</b>
Filtre eau de refroidissement	<b>60253</b>			
Filtre hydraulique de ventilateur	<b>60160</b>			
Kit filtre de transmission automatique	<b>64914</b>			
Filtre ad blue	<b>57929</b>	<b>75705</b>		<b>56579</b>
Filtre de webasto	<b>62118</b>		<b>77088</b>	

### MODÈLE VOLVO 8700 MOTEUR D7E-340 EURO 4, 5 DEP 06/2006

DÉSIGNATION	MANN	DONALDSON	FLEETGUARD	FILTRE ORIGINE
Filtre huile	<b>65338</b>			
Filtre gasoil				
Filtre webasto	<b>62118</b>		<b>77088</b>	
Filtre air	<b>66701</b>			
Filtre liquide de refroidissement	<b>60253</b>			
Filtre boîte i-shift dep 09/2007	<b>73004</b>			
Filtre de climatisation (sutrack)	<b>57216</b>			

### MODÈLE VOLVO 8900 MOTEUR D9B-380E5 380 CV - DEP 10/2010

DÉSIGNATION	MANN	DONALDSON	FLEETGUARD	FILTRE ORIGINE
Filtre huile	<b>42229</b>			
Filtre huile secondaire	<b>35095</b>			
Filtre gasoil	<b>55259</b>			
Filtre air	<b>66701</b>			
Filtre boîte de vitesse i-shift dep 09/2007	<b>73004</b>			
Filtre liquide de refroidissement	<b>60253</b>			
Filtre ad blue	<b>57929</b>	<b>75705</b>		<b>56579</b>

## Volvo

MODÈLE VOLVO 9500 MOTEUR D9A/B/C 380 CV - DEP 02/11 - EURO 5				
DÉSIGNATION	MANN	DONALDSON	FLEETGUARD	FILTRE ORIGINE
Filtre huile x 2	<b>42229</b>			
Filtre huile secondaire	<b>35095</b>			
Filtre gasoil	<b>55259</b>			
Filtre séparateur d'eau	<b>55602</b>			
Filtre boîte de vitesse I shift	<b>73004</b>			
Filtre liquide de refroidissement	<b>60253</b>			
Filtre AD Blue Denoxtronic 1	<b>57929</b>			
Filtre AD Blue Denoxtronic 2	<b>72863</b>			
Filtre à air	<b>66701</b>			

MODÈLE VOLVO 9700, 9900 MOTEUR DH12D380, DH12D420 09/01 - 09/06 - EURO 2, 3				
DÉSIGNATION	MANN	DONALDSON	FLEETGUARD	FILTRE ORIGINE
Filtre huile x 2	<b>42229</b>			
Filtre air secondaire	<b>38095</b>			
Filtre air dep 09/05	<b>35974</b>	<b>74731</b>		
Filtre gasoil	<b>60159</b>			
Filtre séparateur d'eau	<b>55602</b>			
Filtre de webasto	<b>62118</b>		<b>77088</b>	

MODÈLE VOLVO 9700, 9900 MOTEUR DH13C420 DEP 10/09 - EURO 5				
DÉSIGNATION	MANN	DONALDSON	FLEETGUARD	FILTRE ORIGINE
Filtre huile	<b>42229</b>			
Filtre huile secondaire	<b>35095</b>			
Filtre gasoil long life	<b>55259</b>			
Filtre liquide de refroidissement	<b>60253</b>			
Filtre séparateur d'eau	<b>55602</b>			
Filtre boîte de vitesse I-shift dep 09/2007	<b>73004</b>			
Filtre AD blue	<b>57929</b>	<b>75705</b>		<b>56579</b>
Filtre à air	<b>66701</b>			

## Volvo

MODÈLE VOLVO 8700, 9700 MOTEUR DH12E340 - 340 CV, MOTEUR DH12E380 - 380 CV, MOTEUR DH12E420 - 420 CV, MOTEUR DH12E460 - 460 CV - DEP 09/06 - EURO 4, 5				
DÉSIGNATION	MANN	DONALDSON	FLEETGUARD	FILTRE ORIGINE
Filtre huile x 2	<b>42229</b>			
Filtre huile secondaire	<b>35095</b>			
Filtre gasoil	<b>60159</b>			
Filtre liquide de refroidissement	<b>60253</b>			
Filtre air	<b>35974</b>	<b>74731</b>		
Filtre ad blue	<b>57929</b>	<b>75705</b>		<b>56579</b>
Filtre de webasto	<b>62118</b>		<b>77088</b>	
Filtre séparateur d'eau	<b>55602</b>			

MODÈLE VOLVO B10M, B (BERKHOF, HEULIEZ) MOTEUR THD 104 KB/KF/KD, THD 101/102 - 06/81-08/99, THD 10A/285/340/360 - 06/81-08/99 - 08/95-12/00				
DÉSIGNATION	MANN	DONALDSON	FLEETGUARD	FILTRE ORIGINE
Filtre huile x 2	<b>17739</b>	<b>75679</b>	<b>75518</b>	
Filtre huile secondaire	<b>35095</b>			
Filtre gasoil	<b>35086</b>			
Filtre de boîte G7EGS/ G8EGS	<b>17830</b>			
Filtre air jsq 12/00	<b>17509</b>	<b>75691</b>	<b>75467</b>	
Filtre hydraulique ventilateur	<b>17879</b>			
Filtre direction	<b>17592</b>	<b>75642</b>	<b>75512</b>	
Filtre liquide de refroidissement	<b>60253</b>			



### Volkswagen

#### MODÈLE TRANSPORTER T5 2,5TDI (7H,7J) MOTEUR AXD, BNZ 130 CV - 05/03-12/09

DÉSIGNATION	MANN	DONALDSON	FLEETGUARD	FILTRE ORIGINE
Filtre huile	<b>53280</b>			
Filtre gasoil jsq 02/08	<b>56363</b>			
Filtre gasoil dep 03/08	<b>73486</b>			
Filtre à air	<b>53287</b>			
Filtre habitacle	<b>60152</b>			

#### MODÈLE TRANSPORTER 2,0 TDI (7E, 7F) MOTEUR CAAC/CCHA - CAE, CCHB 136 - 140 CV - DEP 09/09

DÉSIGNATION	MANN	DONALDSON	FLEETGUARD	FILTRE ORIGINE
Filtre huile	<b>82130</b>			
Filtre gasoil	<b>56363</b>			
Filtre à air	<b>53287</b>			
Filtre habitacle	<b>60152</b>			

#### MODÈLE LT 46 MOTEUR 2,8 TDI - DEP 04/02 JSQ 05/06

DÉSIGNATION	MANN	DONALDSON	FLEETGUARD	FILTRE ORIGINE
Filtre huile	<b>51205</b>			
Filtre gasoil	<b>54306</b>			
Filtre air	<b>35077</b>			
Filtre climatisation	<b>48042</b>			

#### MODÈLE CRAFTER 30-35, 2,5D MOTEUR 2E, BJJ - 88, 109, 136, 163 CV DEP 04/2006 JSQ 06/2011

DÉSIGNATION	MANN	DONALDSON	FLEETGUARD	FILTRE ORIGINE
Filtre huile	<b>53281</b>			
Filtre gasoil	<b>75081</b>			<b>64920</b>
Filtre air	<b>61930</b>		<b>75460</b>	
Filtre d'habitacle	<b>58066</b>			

### Yutong

#### MODÈLE ZK6121HQ MOTEUR CUMMINS ISL 8.9 - EURO 5

DÉSIGNATION	MANN	DONALDSON	FLEETGUARD	FILTRE ORIGINE
Filtre huile			<b>81173</b>	
Filtre gasoil	<b>53719</b>		<b>74926</b>	
Filtre séparateur d'eau R120T	<b>93539</b>			
Filtre air primaire + secondaire			<b>89954</b>	
Filtre air seul			<b>93538</b>	





#### MODÈLE ZK6121HQ EC12,13 MOTEUR DAF MX11 - EURO 5

DÉSIGNATION	MANN	DONALDSON	FLEETGUARD	FILTRE ORIGINE
Filtre huile	<b>94296</b>			<b>93574</b>
Filtre gasoil				<b>91468</b>
Filtre air primaire + secondaire			<b>89954</b>	
Filtre air seul			<b>93538</b>	



Donaldson  
FILTRATION SOLUTIONS



<b>RÉF ATS</b>	DÉSIGNATION	APPLICATION	
<b>82135</b>	Bol préfiltre gasoil épurateur d'eau	Evobus Travego, Intouro, Citaro, Tourino, Integro New, Turismo, Setra série 400	
<b>RÉF ATS</b>	DÉSIGNATION	APPLICATION	
<b>76501</b>	Cuve de filtre à gasoil	Irisbus Recreo, Axer	
<b>76502</b>	Joint	Moteur Cursor	
<b>RÉF ATS</b>	DÉSIGNATION	APPLICATION	
<b>91035</b>	Bol préfiltre gasoil	Man SL/SU, NL/NG/NM, Lion's R07, R08, R09 Neoplan Trendliner, Tourliner, Skyliner, Starliner, Centroliner	
<b>RÉF ATS</b>	DÉSIGNATION	APPLICATION	
<b>91036</b>	Bol préfiltre gasoil sans capteur	Scania DC9, DC11, DCDT12, DC13, K124, K114, Irizar Century, PB	
<b>RÉF ATS</b>	DÉSIGNATION	APPLICATION	
<b>92135</b>	Bol préfiltre gasoil sans capteur		
<b>92137</b>	Bol préfiltre gasoil avec capteur	Scania série 4 Moteur DC-DSC-DSI9, DC11, DC-DSC12	
<b>RÉF ATS</b>	DÉSIGNATION	APPLICATION	
<b>92136</b>	Couvercle filtre gasoil	Scania série 4, série F/K/N Moteur DC9, DC-DT12HPI	
<b>RÉF ATS</b>	DÉSIGNATION	APPLICATION	
<b>91041</b>	Bol préfiltre gasoil avec capteur	Volvo 9500/9700/9900 Moteur D9A/B, DH12E, D13C/F	
<b>RÉF ATS</b>	DÉSIGNATION	APPLICATION	
<b>91034</b>	Bol préfiltre gasoil avec capteur	Volvo 9500/9700/9900 Moteur D9B, D12D	

RÉF ATS	APPLICATION	PARTICULARITÉS	
<b>42662</b>	Bouchon de remplissage d'huile Série 400 Setra, Mercedes Intouro, Tourismo, 0340, 0345, 0350, 0404, 0405, 0408, 0510, 0530, 0550, 0580, Neoplan moteur Mercedes	Moteur OM501, 502 457LA, 906LA, 926LA OM401, OM402, OM422, OM427, OM441, OM442, OM447, OM904, OM906	

### Mercedes

RÉF ATS	APPLICATION	PARTICULARITÉS	
<b>63897</b>	Bouchon de filtre à huile	OM457 HLA/IV, OM, M447 HLAG, M906 LAG, OM906, OM906 LA, 926 LA TE 100 X 3/144 X 25 nm	
<b>63898</b>	Bouchon de filtre à huile	OM904 LA, OM906 LA, OM924 LA TE 100 X 3/80.5 X 25 nm	
<b>63899</b>	Bouchon de filtre à huile	OM906 LA, OM906HLA / LA, OM924 LA, OM926 LA, OM501 LA TE 112 X 3/85.5 X 25 nm	

### Evobus

RÉF ATS	APPLICATION	PARTICULARITÉS	
<b>43088</b>	Bouchon de vidange	OM401, OM402, OM422, OM427, OM441 OM442, OM447, OM904, OM906	
<b>64918</b>	Joint	26 X 32 X 1,5 7603 A/CU	

RÉF ATS	APPLICATION	PARTICULARITÉS	
<b>45320</b>	Bouchon de vidange M 24 X 1,5 X 13	D2865 LUH02/03 D2866 KU/KUL/ LU/LUL/LXU/LXUH/LUH/ LUH05/LUH20-21/ TUH/TUM/ UH/UM/UM01/ LF02-10/14-16 D0824 FLF01/02/04-07/LFO-01/LF01-02/ LOH01/02/03 D0826 LF/LF01/02/04-08/LF15-17/LF217/ GF/GF01/GFA/GFA01/GFA KOOP-VW/LUH/ LUH01-06/08/10/LUH213/LFL03/06-09/ LOH/LOH01-08/LOH Vanhool	

### Scania

RÉF ATS	APPLICATION	PARTICULARITÉS	
<b>64913</b>	Bouchon de vidange Scania K113 CLA/CLB/CRA K113 CLP/TLP 114G K114	DS/DSC 11 DSC11 DSC11 M 38 X 1,5 X 9/12	

## Volvo

RÉF ATS	APPLICATION	PARTICULARITÉS	
<b>64915</b>	Bouchon de vidange B10B, B10M, B10M (BR), B10R B12, B12 (BR)	THD101, THD102, THD103, THD104, THD100, THD101, THD102, THD101KC, THD100, THD101, THD102, TD122, 123, TD122 - 1 1/2" - 16UNF	
<b>64916</b>	Joint	38 X 43 X 1,5	
<b>64917</b>	B7, B7F, B7L / B7L DD, B7R / B7R (BR), B10B, B10M, B10M, B10M (BR), B10L, B10R (BR), B12 / B12 (BR)	D7A, D7A, B, D7C, D7A, B, C, THD101, THD102, THD103, THD101, 102 / DH 10A, D10B, THG103 / THD104GH 10A,B,C / DH10 A THD100, TD122 - 1 3/43 - 16 UNF	
RÉF ATS	APPLICATION	PARTICULARITÉS	
<b>56596</b>	Jauge de niveau constant sur réserve Irisbus, Recreo, Axer	Moteur F2BE Couple de serrage 8 nm	
<b>62533</b>	Joint arrière		
<b>62534</b>	Joint arrière		

## PROTECTIONS SOUS-MOTEUR







## Evobus

RÉF ATS	DÉSIGNATION	CORRESPONDANCE	APPLICATION	
<b>94132</b>	Recouvrement arrière	<b>A6296930117</b>	S411HD, S415-416 GTHD, S431DT, Turismo New 15, 16, 17 RHD, Travego RHD SHD	
<b>94133</b>	Recouvrement sous le radiateur	<b>A6296930717</b>	S415-419 GTHD, S411HD, S415HD, S431DT, S415-417HDH, Turismo New 15, 16, 17 RHD, Travego RHD, SHD	
<b>94131</b>	Recouvrement à l'avant	<b>A6296930917</b>	S415-417 HDH, S415-417 GTHD Turismo 15, 16, 17 RHD, Travego	
<b>94134</b>	Recouvrement à l'avant	<b>A6296930017</b>	S415HD, S415-416 GTHD, Travego RHD, SHD	
<b>94136</b>	Recouvrement au centre à l'arrière	<b>A3566800607</b>	Tourismo Euro 3 Tourismo Euro 2	
<b>94138</b>	Recouvrement gauche à l'arrière	<b>A6133806207</b>	Tourismo Euro 3	
<b>94135</b>	Recouvrement au centre en haut	<b>A3566800707</b>	Tourismo Euro 3 Tourismo Euro 2	
<b>60281</b>	Carenage moteur arrière droit véhicule I 2500 mm	<b>6286830708</b>	Citaro 0530/L/G/CNG/Ü/MÜ/LÜ Euro 2, 3, 4	
<b>60282</b>	Carenage moteur arrière gauche	<b>6286830408</b>		
<b>60275</b>	Carenage avant gauche véhicule I 2550 mm	<b>6286830208</b>		

### Evobus

RÉF ATS	DÉSIGNATION	CORRESPONDANCE	APPLICATION	
<b>60276</b>	Carenage arrière milieu gauche véhicule l 2550 mm	<b>6286830508</b>	Citaro 0530/L/G/CNG/Ü/MÜ/LÜ Euro 2, 3, 4	
<b>60277</b>	Carenage arrière droit	<b>6286831408</b>		
<b>94427</b>	Carenage centrale avant à l'arrière	<b>6286831010</b>		
<b>94428</b>	Carenage arrière droit	<b>6286831708</b>		
<b>94426</b>	Carenage arrière centrale milieu	<b>6286800009</b>		
<b>94429</b>	Carenage gauche avant à l'arrière	<b>6286832508</b>		
<b>94458</b>	Carenage arrière	<b>6286930205</b>		S313- 315/ SG 321-H /GT UL
<b>94459</b>	Carenage sous radiateur	<b>6296930206</b>	Euro 3 dep 2003	

### Iveco

RÉF ATS	DÉSIGNATION	CORRESPONDANCE	APPLICATION	
<b>77451</b>	Protection sous moteur gauche	<b>504192170</b>	Arway, Crossway LE, Crossway, Recreo dep 2007, Evadys H	
<b>77450</b>	Protection sous moteur milieu	<b>504192194</b>		
<b>77449</b>	Protection sous moteur droit	<b>504098326</b>		
<b>77478</b>	Protection sous moteur gauche	<b>5006000737</b>	Recreo C955 Euro 3 Axer C956 Euro 3	
<b>77479</b>	Protection sous moteur milieu	<b>5006000735</b>		
<b>77480</b>	Protection sous moteur droit	<b>5006000736</b>		

### Man

RÉF ATS	DÉSIGNATION	CORRESPONDANCE	APPLICATION	
<b>94424</b>	Grand carter sous moteur milieu	<b>81720105252</b>	Lion's City / M/G/GL/Ü/DD Châssis A20 / A21 / A22/ A23 / A24/ A25/ A26/ A28/ A30/ A31/ A39/ A51/ A69	
<b>94425</b>	Petit carter sous moteur milieu	<b>81720105129</b>	Lion's City / M/G/GL/Ü/DD Fast Scoler 3 A91 châssis A20 / A21 / A22/ A23 / A24/ A25/ A26/ A28/ A30/ A31/ A39/ A51/ A69/ A78	